



BIPOLAR ANALOG INTEGRATED CIRCUIT

μ PC3239TB

3.3 V, SILICON MMIC MEDIUM OUTPUT POWER AMPLIFIER

DESCRIPTION

The μ PC3239TB is a silicon monolithic integrated circuit designed as IF amplifier for DBS LNB.

This device exhibits low noise figure and high power gain characteristics.

This IC is manufactured using our UHS0 (Ultra High Speed Process) bipolar process.

FEATURES

- Low current : $I_{CC} = 29.0$ mA TYP.
- Medium output power : $P_{O(sat)} = +12.5$ dBm TYP. @ $f = 1.0$ GHz
: $P_{O(sat)} = +10$ dBm TYP. @ $f = 2.2$ GHz
- High linearity : $P_{O(1dB)} = +10$ dBm TYP. @ $f = 1.0$ GHz
: $P_{O(1dB)} = +8$ dBm TYP. @ $f = 2.2$ GHz
- Power gain : $G_P = 25$ dB TYP. @ $f = 1.0$ GHz
: $G_P = 25.5$ dB TYP. @ $f = 2.2$ GHz
- Gain flatness : $\Delta G_P = 1.0$ dB TYP. @ $f = 1.0$ to 2.2 GHz
- Noise Figure : $NF = 4.0$ dB TYP. @ $f = 1.0$ GHz
: $NF = 4.3$ dB TYP. @ $f = 2.2$ GHz
- Supply voltage : $V_{CC} = 3.0$ to 3.6 V
- Port impedance : input/output 50Ω

APPLICATIONS

- IF amplifiers in DBS LNB, other L-band amplifiers, etc.

ORDERING INFORMATION

Part Number	Order Number	Package	Marking	Supplying Form
μ PC3239TB-E3	μ PC3239TB-E3-A	6-pin super minimold (Pb-Free)	C3V	<ul style="list-style-type: none">• Embossed tape 8 mm wide• Pin 1, 2, 3 face the perforation side of the tape• Qty 3 kpcs/reel

Remark To order evaluation samples, please contact your nearby sales office

Part number for sample order: μ PC3239TB-A

Caution Observe precautions when handling because these devices are sensitive to electrostatic discharge.

The information in this document is subject to change without notice. Before using this document, please confirm that this is the latest version.

PIN CONNECTIONS AND INTERNAL BLOCK DIAGRAM

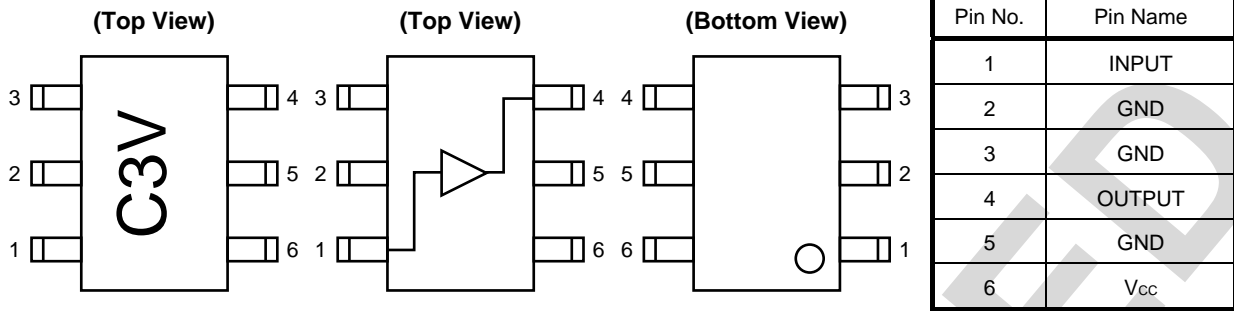

PRODUCT LINE-UP OF 3 V or 3.3 V-BIAS SILICON MMIC MEDIUM OUTPUT POWER AMPLIFIER
 (T_A = +25°C, V_{CC} = V_{out} = 3.0 V or 3.3 V, Z_s = Z_L = 50 Ω)

Part No.	V _{CC} (V)	I _{CC} (mA)	G _P (dB)	NF (dB)	P _O (1 dB) (dBm)	P _O (sat) (dBm)	Package	Marking	
μ PC2762TB	3.0	26.5	13.0 (0.9 GHz)	6.5 (0.9 GHz)	+8.0 (0.9 GHz)	+9.0 (0.9 GHz)	6-pin super minimold	C1Z	
				15.5 (1.9 GHz)	7.0 (1.9 GHz)	+7.0 (1.9 GHz)		+8.5 (1.9 GHz)	C2A
μ PC2763TB		27.0	20.0 (0.9 GHz)	5.5 (0.9 GHz)	+9.5 (0.9 GHz)	+11.0 (0.9 GHz)			
			21.0 (1.9 GHz)	5.5 (1.9 GHz)	+6.5 (1.9 GHz)	+8.0 (1.9 GHz)			
μ PC2771TB		36.0	21.0 (0.9 GHz)	6.0 (0.9 GHz)	+11.5 (0.9 GHz)	+12.5 (0.9 GHz)			C2H
			21.0 (1.5 GHz)	6.0 (1.5 GHz)	+9.5 (1.5 GHz)	+11.0 (1.5 GHz)			
μ PC8181TB	23.0	19.0 (0.9 GHz)	4.5 (0.9 GHz)	4.5 (0.9 GHz)	+8.0 (0.9 GHz)	+9.5 (0.9 GHz)		C3E	
			21.0 (1.9 GHz)	4.5 (1.9 GHz)	+7.0 (1.9 GHz)	+9.0 (1.9 GHz)			
			22.0 (2.4 GHz)	4.5 (2.4 GHz)	+7.0 (2.4 GHz)	+9.0 (2.4 GHz)			
μ PC8182TB	30.0	21.5 (0.9 GHz)	4.5 (0.9 GHz)	4.5 (0.9 GHz)	+9.5 (0.9 GHz)	+11.0 (0.9 GHz)		C3F	
			20.5 (1.9 GHz)	4.5 (1.9 GHz)	+9.0 (1.9 GHz)	+10.5 (1.9 GHz)			
			20.5 (2.4 GHz)	5.0 (2.4 GHz)	+8.0 (2.4 GHz)	+10.0 (2.4 GHz)			
μ PC3239TB	3.3	29.0	25 (1.0 GHz)	4.0 (1.0 GHz)	+10 (1.0 GHz)	+12.5 (1.0 GHz)		C3V	
			25.5 (2.2 GHz)	4.3 (2.2 GHz)	+8 (2.2 GHz)	+10 (2.2 GHz)			

Remark Typical performance. Please refer to **ELECTRICAL CHARACTERISTICS** in detail.

ABSOLUTE MAXIMUM RATINGS

Parameter	Symbol	Conditions	Ratings	Unit
Supply Voltage	V _{CC}	T _A = +25°C, pin 4 and 6	4.0	V
Total Circuit Current	I _{CC}	T _A = +25°C, pin 4 and 6	55	mA
Power Dissipation	P _D	T _A = +85°C Note	270	mW
Operating Ambient Temperature	T _A		-40 to +85	°C
Storage Temperature	T _{stg}		-55 to +150	°C
Input Power	P _{in}	T _A = +25°C	+10	dBm

Note Mounted on double-sided copper-clad 50 × 50 × 1.6 mm epoxy glass PWB

RECOMMENDED OPERATING RANGE

Parameter	Symbol	Conditions	MIN.	TYP.	MAX.	Unit
Supply Voltage	V _{CC}	The same voltage should be applied to pin 4 and 6.	3.0	3.3	3.6	V
Operating Ambient Temperature	T _A		-40	+25	+85	°C

ELECTRICAL CHARACTERISTICS ($T_A = +25^\circ\text{C}$, $V_{CC} = V_{out} = 3.3\text{ V}$, $Z_S = Z_L = 50\ \Omega$, unless otherwise specified)

Parameter	Symbol	Test Conditions	MIN.	TYP.	MAX.	Unit
Circuit Current	I _{CC}	No input signal	23	29.0	36.5	mA
Power Gain 1	G _{P1}	f = 0.25 GHz, P _{in} = -30 dBm	21.5	24.5	27.5	dB
Power Gain 2	G _{P2}	f = 1.0 GHz, P _{in} = -30 dBm	22	25	28	
Power Gain 3	G _{P3}	f = 1.8 GHz, P _{in} = -30 dBm	22.5	25.5	28.5	
Power Gain 4	G _{P4}	f = 2.2 GHz, P _{in} = -30 dBm	22.5	25.5	28.5	
Saturated Output Power 1	P _{O(sat)1}	f = 1.0 GHz, P _{in} = -5 dBm	+10	+12.5	-	dBm
Saturated Output Power 2	P _{O(sat)2}	f = 2.2 GHz, P _{in} = -10 dBm	+7	+10	-	
Gain 1 dB Compression Output Power 1	P _{O(1dB)1}	f = 1.0 GHz	+7.5	+10	-	dBm
Gain 1 dB Compression Output Power 2	P _{O(1dB)2}	f = 2.2 GHz	+5	+8	-	
Noise Figure 1	NF1	f = 1.0 GHz	-	4.0	4.8	dB
Noise Figure 2	NF2	f = 2.2 GHz	-	4.3	5.1	
Isolation 1	ISL1	f = 1.0 GHz, P _{in} = -30 dBm	28	35	-	dB
Isolation 2	ISL2	f = 2.2 GHz, P _{in} = -30 dBm	28	35	-	
Input Return Loss 1	RL _{in1}	f = 1.0 GHz, P _{in} = -30 dBm	10	25	-	dB
Input Return Loss 2	RL _{in2}	f = 2.2 GHz, P _{in} = -30 dBm	10	15	-	
Output Return Loss 1	RL _{out1}	f = 1.0 GHz, P _{in} = -30 dBm	15	25	-	dB
Output Return Loss 2	RL _{out2}	f = 2.2 GHz, P _{in} = -30 dBm	15	25	-	

STANDARD CHARACTERISTICS FOR REFERENCE

($T_A = +25^\circ\text{C}$, $V_{CC} = V_{out} = 3.3\text{ V}$, $Z_S = Z_L = 50\ \Omega$, unless otherwise specified)

Parameter	Symbol	Test Conditions	Reference Value	Unit
Power Gain 5	G _{P5}	f = 2.6 GHz, P _{in} = -30 dBm	24.5	dB
Power Gain 6	G _{P6}	f = 3.0 GHz, P _{in} = -30 dBm	22.5	
Gain Flatness	ΔG _P	f = 1.0 to 2.2 GHz, P _{in} = -30 dBm	1.0	dB
K factor 1	K1	f = 1.0 GHz, P _{in} = -30 dBm	1.6	-
K factor 2	K2	f = 2.2 GHz, P _{in} = -30 dBm	1.5	-
Output 3rd Order Intercept Point 1	OIP ₃₁	f1 = 1 000 MHz, f2 = 1 001 MHz	21	dBm
Output 3rd Order Intercept Point 2	OIP ₃₂	f1 = 2 200 MHz, f2 = 2 201 MHz	15.5	
2nd Order Intermodulation Distortion	IM ₂	f1 = 1 000 MHz, f2 = 1 001 MHz, P _{out} = -5 dBm/tone	37	dBc
2nd Harmonic	2f ₀	f0 = 1.0 GHz, P _{out} = -15 dBm	57	dBc

TEST CIRCUIT

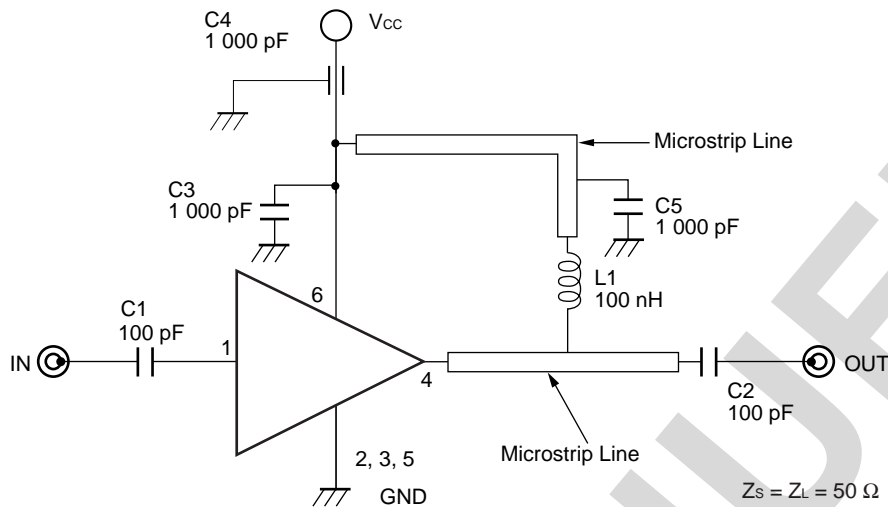

The application circuits and their parameters are for reference only and are not intended for use in actual design-ins.

COMPONENTS OF TEST CIRCUIT FOR MEASURING ELECTRICAL CHARACTERISTICS

	Type	Value
L1 ^{Note}	Chip Inductor	100 nH
C1, C2	Chip Capacitor	100 pF
C3, C5	Chip Capacitor	1 000 pF
C4	Feed-through Capacitor	1 000 pF

Note There is a case to show a dimple wave of characteristic by a chip inductor L1 part in the high frequency area. In that case, please reduce a value of L1.

INDUCTOR FOR THE OUTPUT PIN

The internal output transistor of this IC, to output medium power. To supply current for output transistor, connect an inductor between the Vcc pin (pin 6) and output pin (pin 4). Select inductance, as the value listed above.

The inductor has both DC and AC effects. In terms of DC, the inductor biases the output transistor with minimum voltage drop to output enable high level. In terms of AC, the inductor makes output-port impedance higher to get enough gain. In this case, large inductance and Q is suitable (Refer to the following page).

CAPACITORS FOR THE Vcc, INPUT AND OUTPUT PINS

Capacitors of 1 000 pF are recommendable as the bypass capacitor for the Vcc pin and the coupling capacitors for the input and output pins.

The bypass capacitor connected to the Vcc pin is used to minimize ground impedance of Vcc pin. So, stable bias can be supplied against Vcc fluctuation.

The coupling capacitors, connected to the input and output pins, are used to cut the DC and minimize RF serial impedance. Their capacitances are therefore selected as lower impedance against a 50 Ω load. The capacitors thus perform as high pass filters, suppressing low frequencies to DC.

To obtain a flat gain from 100 MHz upwards, 1 000 pF capacitors are used in the test circuit. In the case of under 10 MHz operation, increase the value of coupling capacitor such as 10 000 pF. Because the coupling capacitors are determined by equation, $C = 1/(2 \pi Rf_c)$.

ILLUSTRATION OF THE TEST CIRCUIT ASSEMBLED ON EVALUATION BOARD

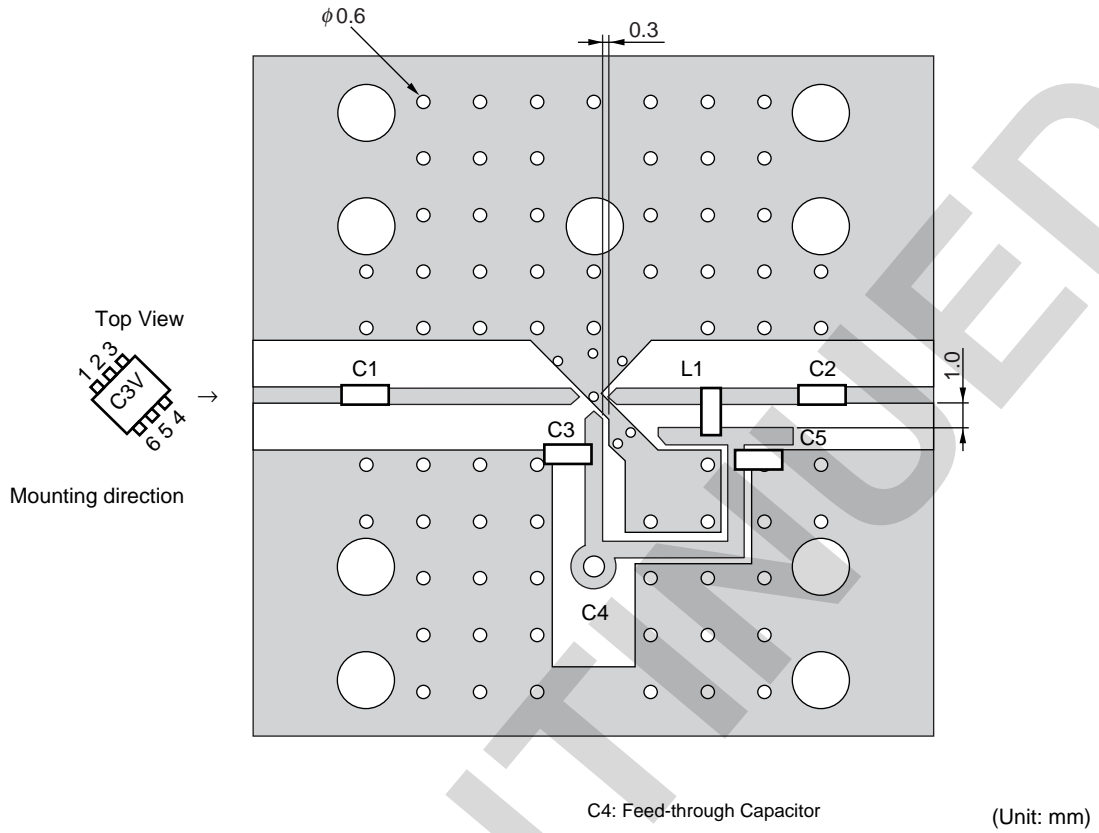

COMPONENT LIST

	Value	Size
L1	100 nH	1005
C1, C2	100 pF	1608
C3, C5	1 000 pF	1005
C4	1 000 pF	Feed-through Capacitor

Notes

1. 30 × 30 × 0.4 mm double sided 35 μm copper clad polyimide board.
2. Back side: GND pattern
3. Au plated on pattern
4. ○: Through holes

TYPICAL CHARACTERISTICS ($T_A = +25^\circ\text{C}$, $V_{CC} = V_{out} = 3.3\text{ V}$, $Z_s = Z_L = 50\ \Omega$, unless otherwise specified)

CIRCUIT CURRENT vs. SUPPLY VOLTAGE

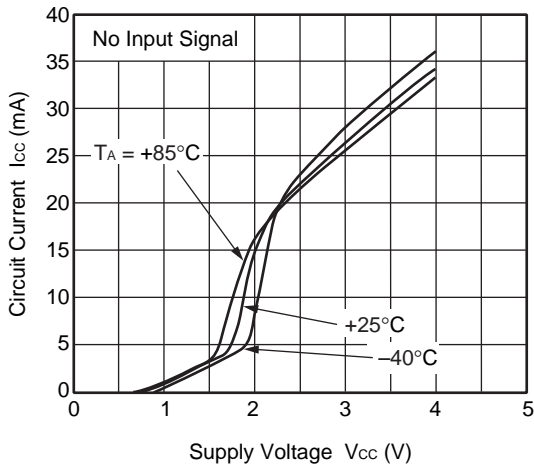

CIRCUIT CURRENT vs. OPERATING AMBIENT TEMPERATURE

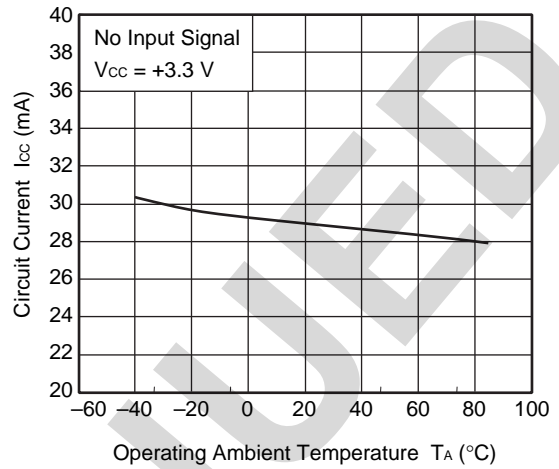

POWER GAIN vs. FREQUENCY

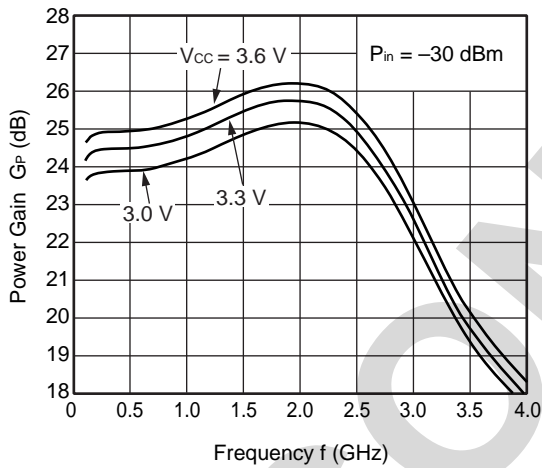

INPUT RETURN LOSS vs. FREQUENCY

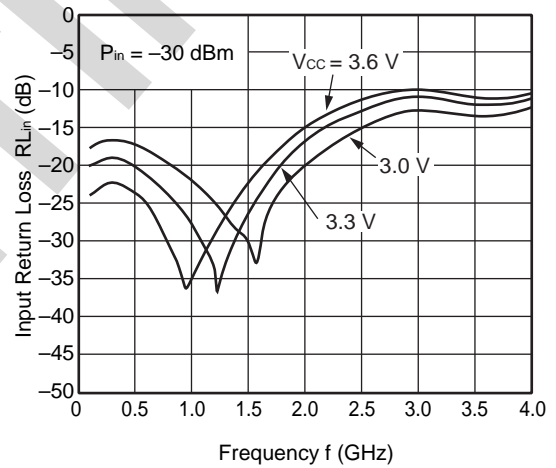

ISOLATION vs. FREQUENCY

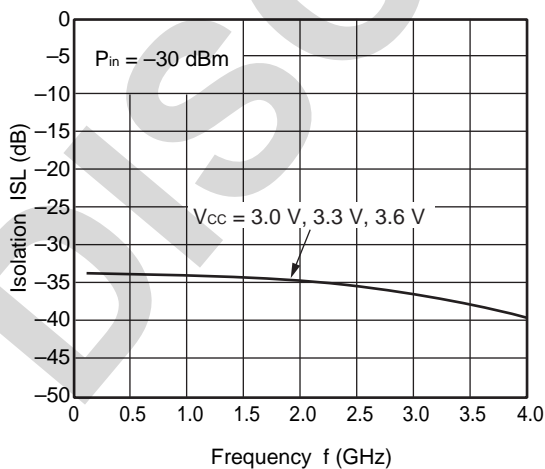

OUTPUT RETURN LOSS vs. FREQUENCY

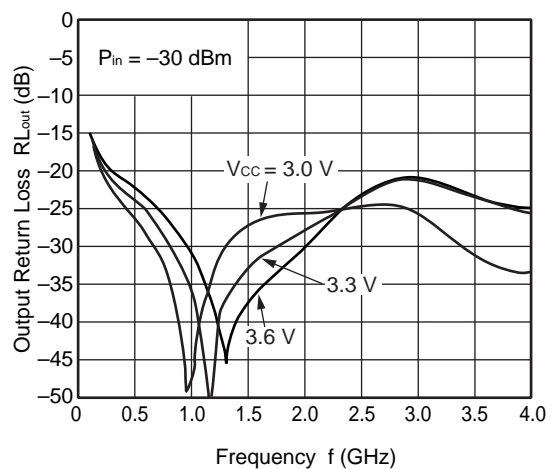

Remark The graphs indicate nominal characteristics.

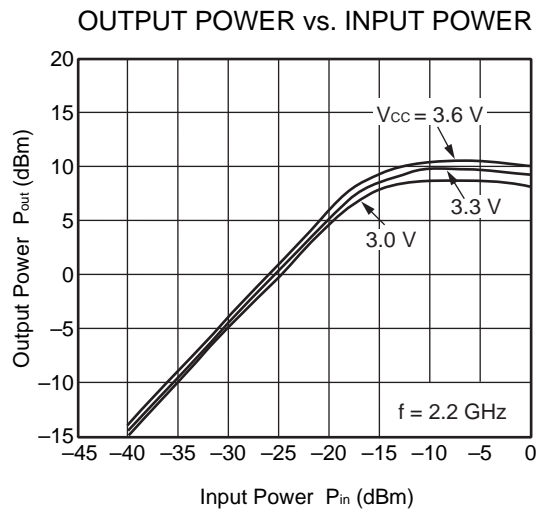
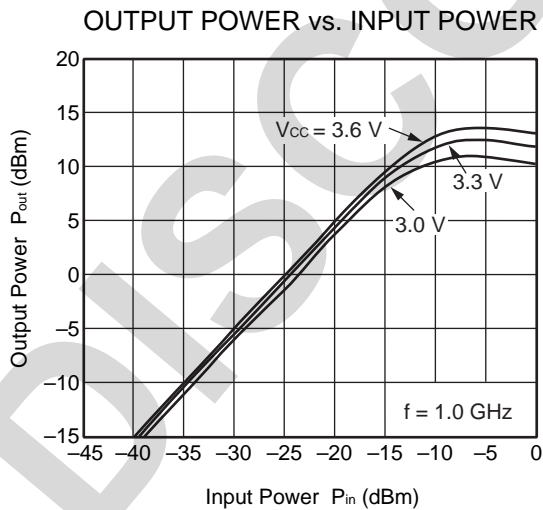
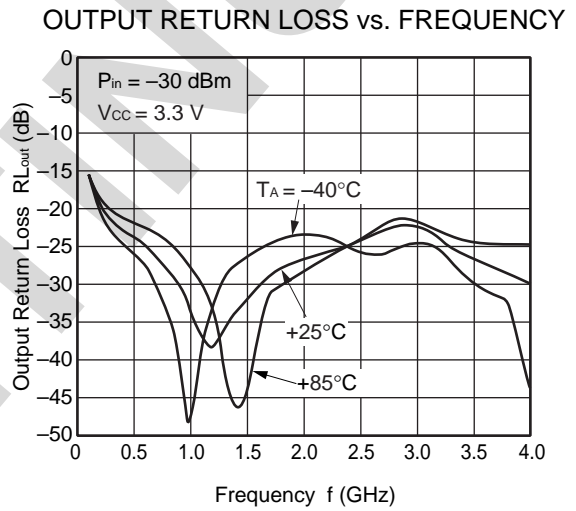
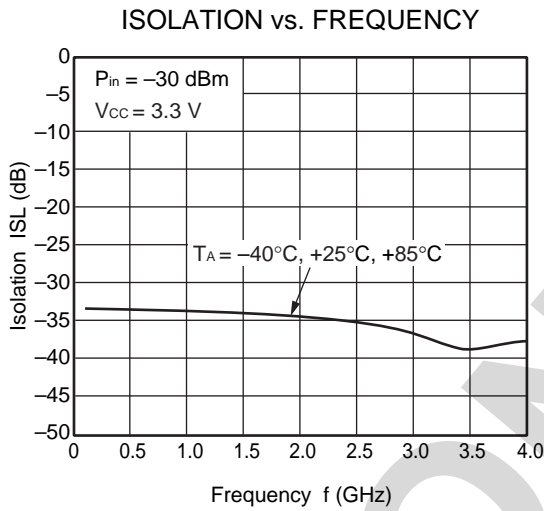
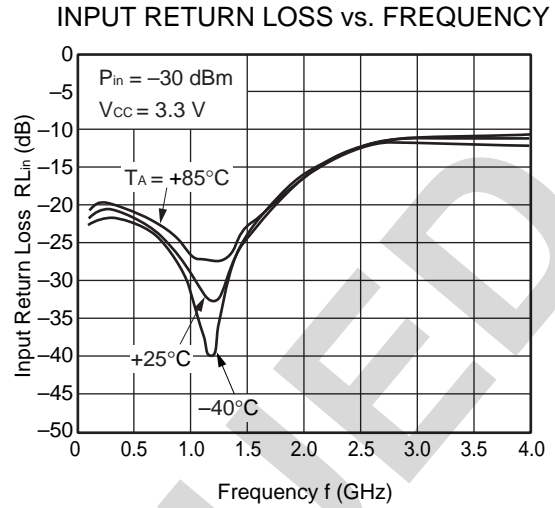
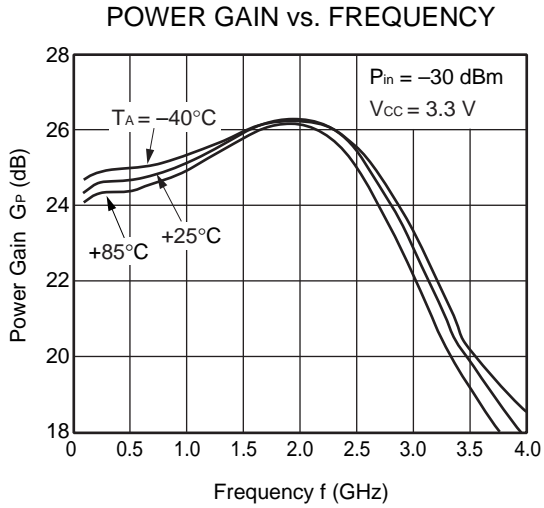

Remark The graphs indicate nominal characteristics.

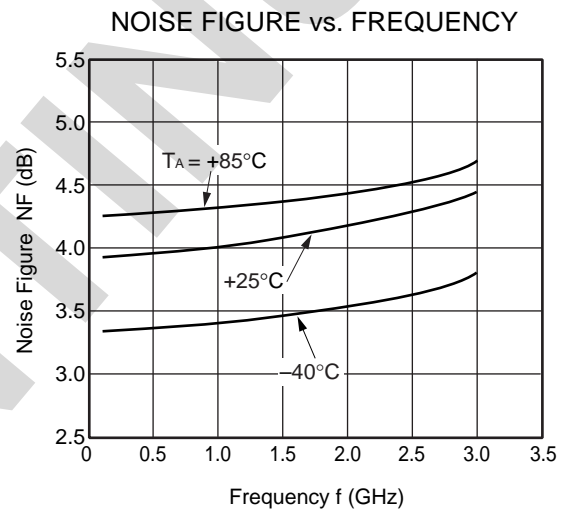
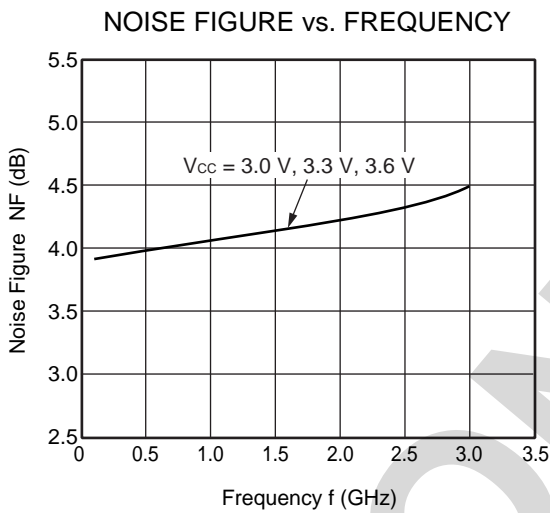
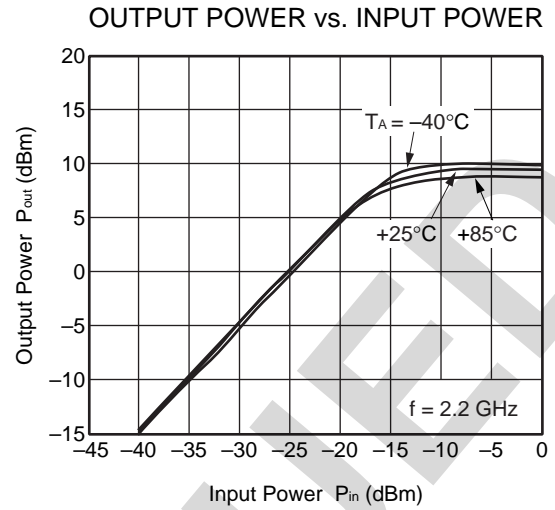
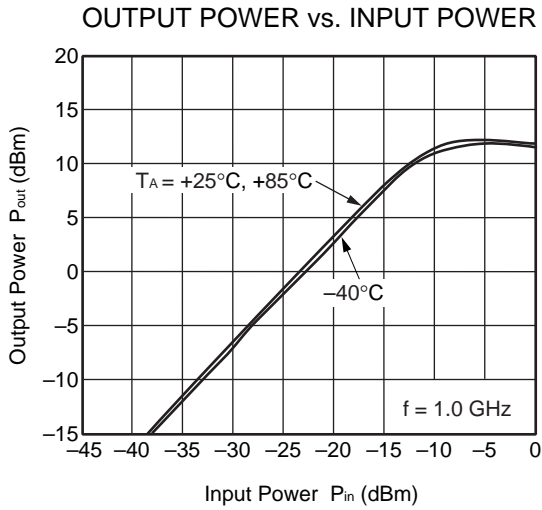

Remark The graphs indicate nominal characteristics.

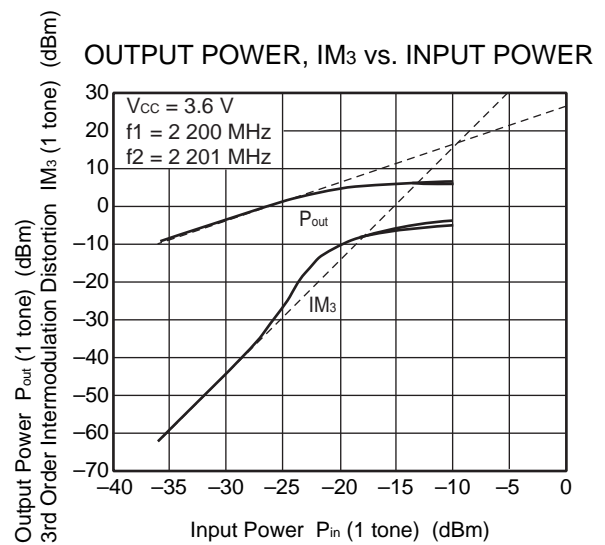
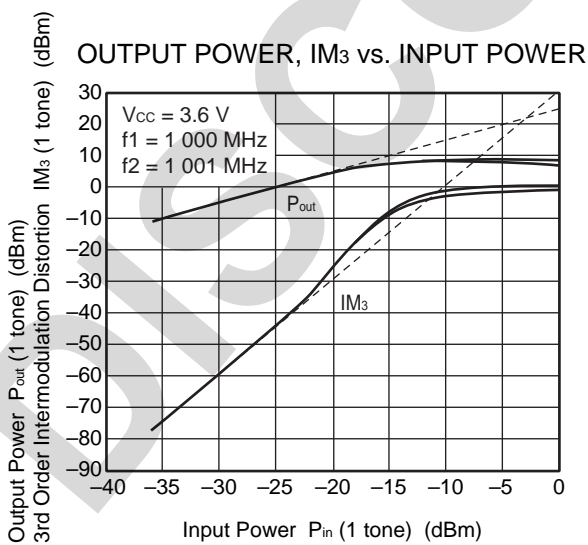
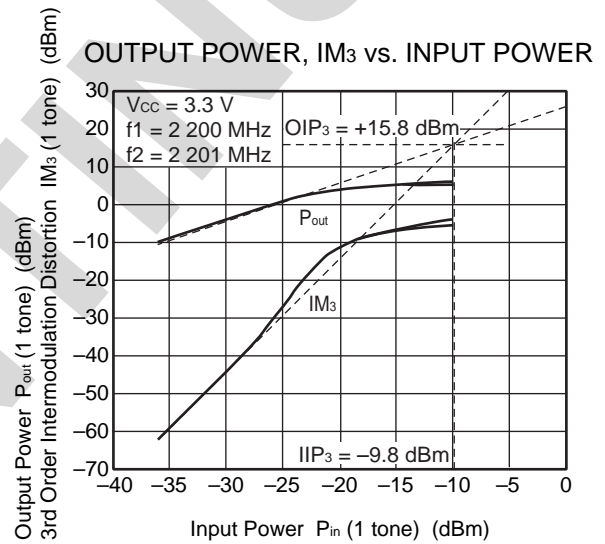
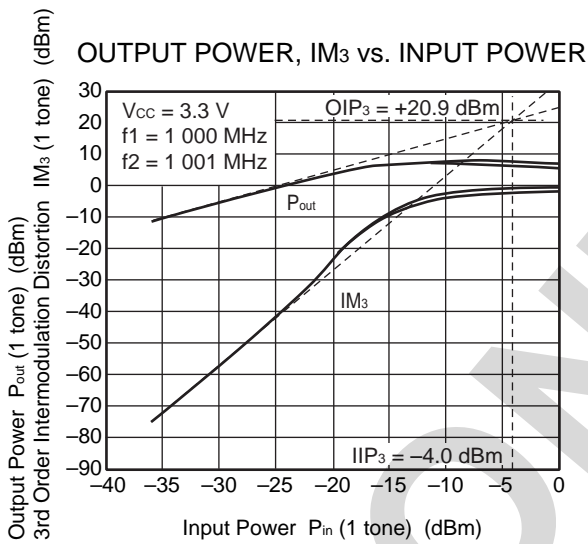
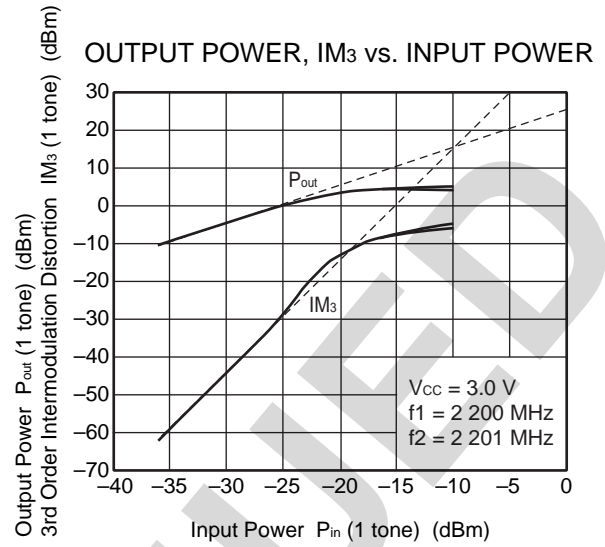
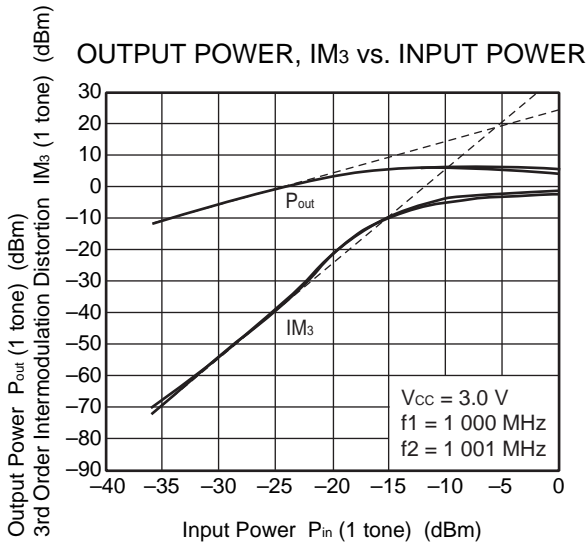

Remark The graphs indicate nominal characteristics.

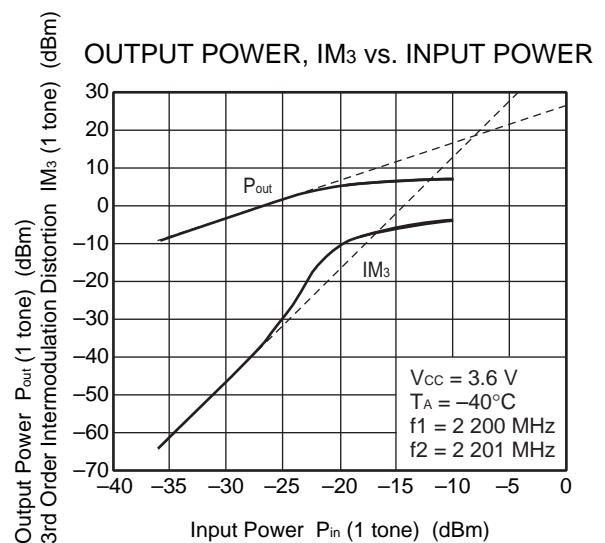
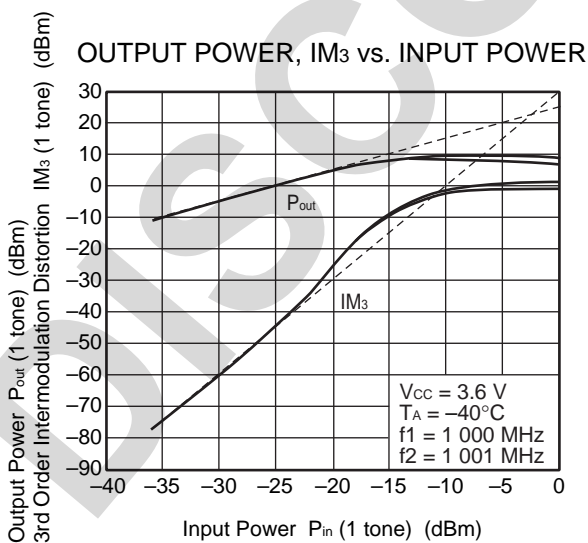
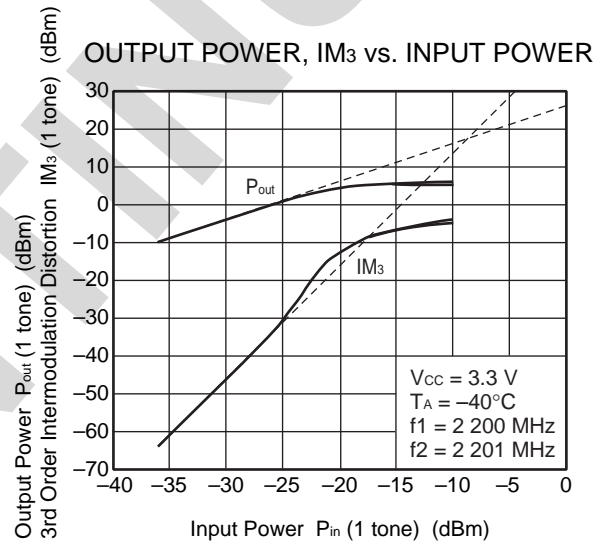
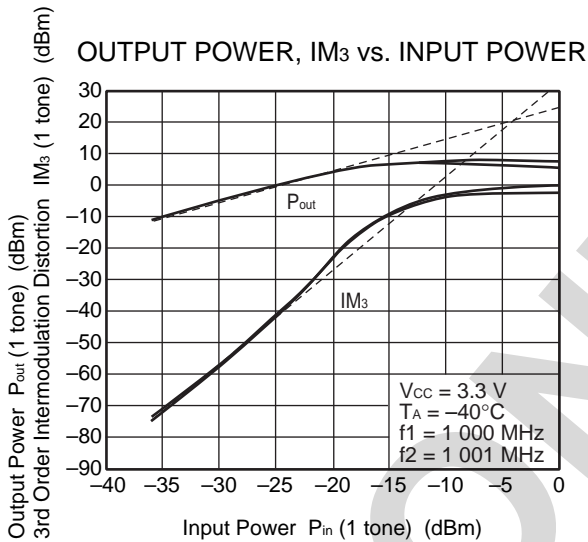
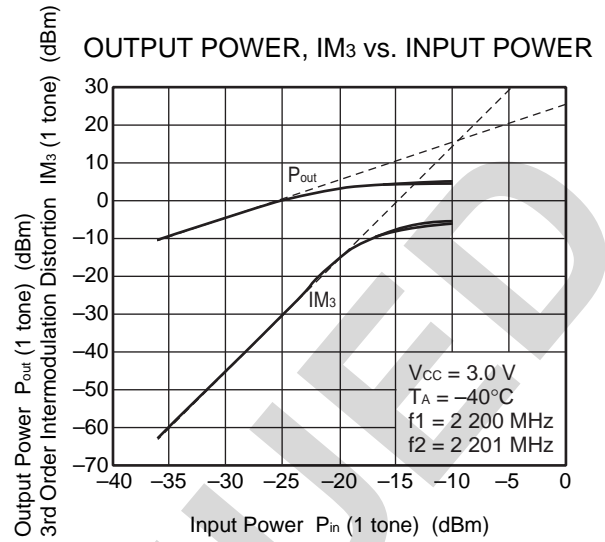
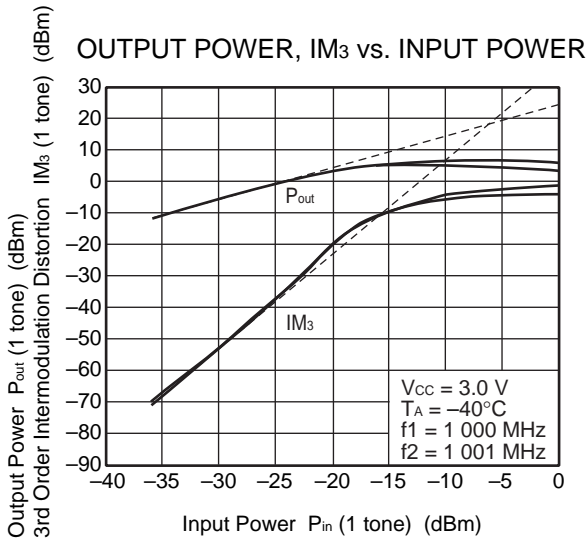

Remark The graphs indicate nominal characteristics.

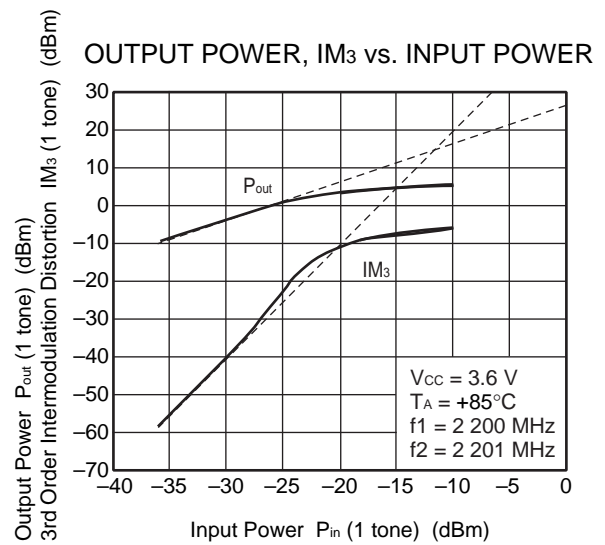
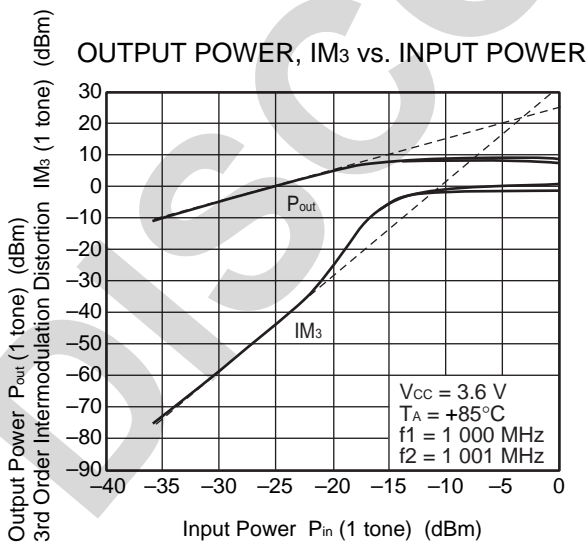
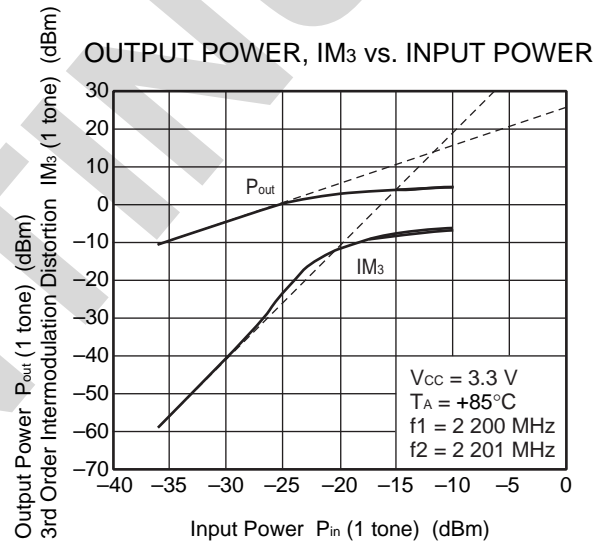
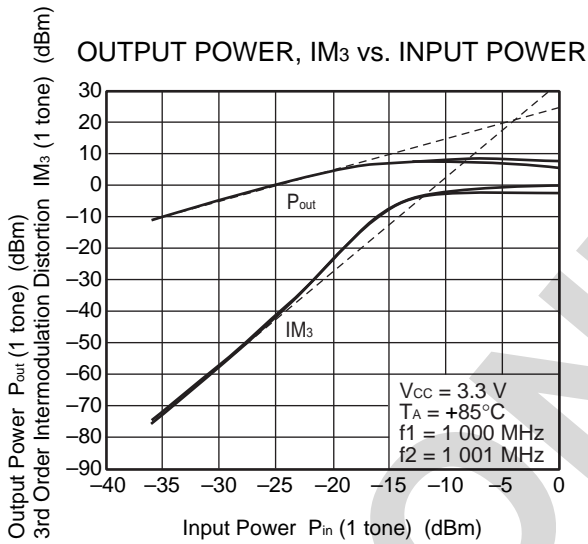
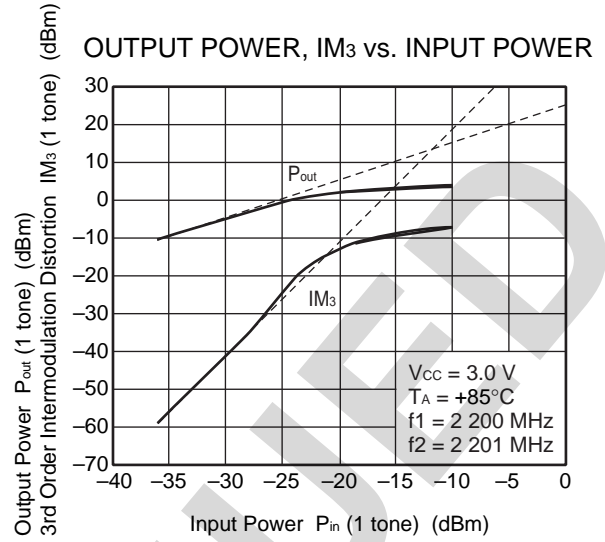
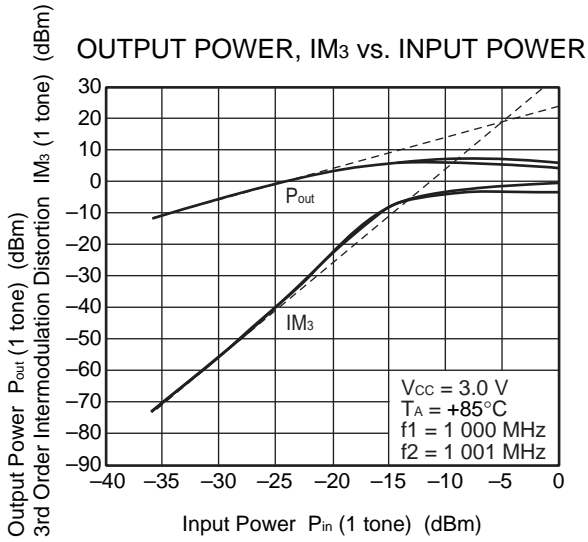

Remark The graphs indicate nominal characteristics.

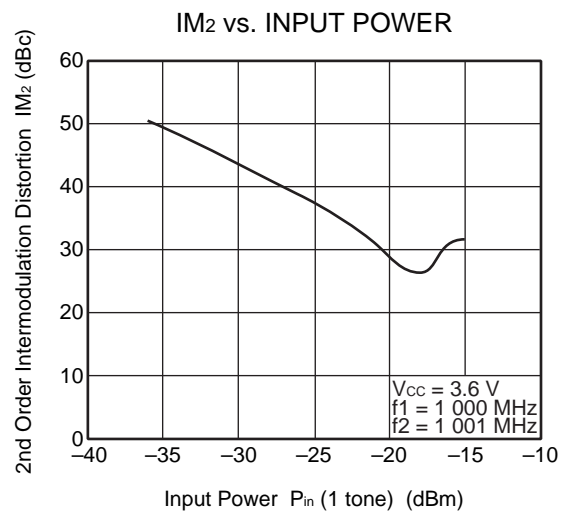
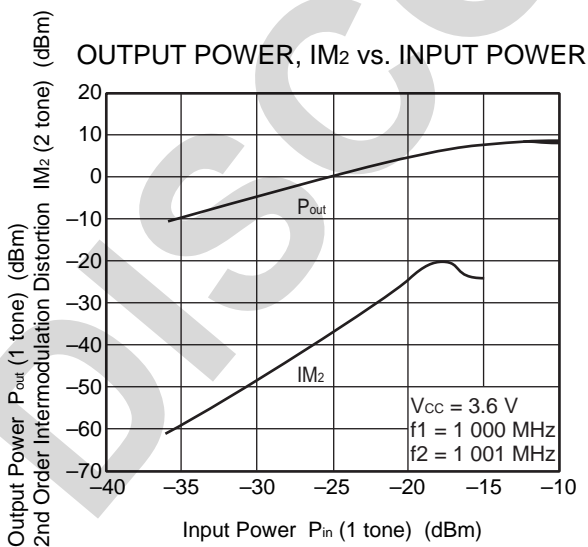
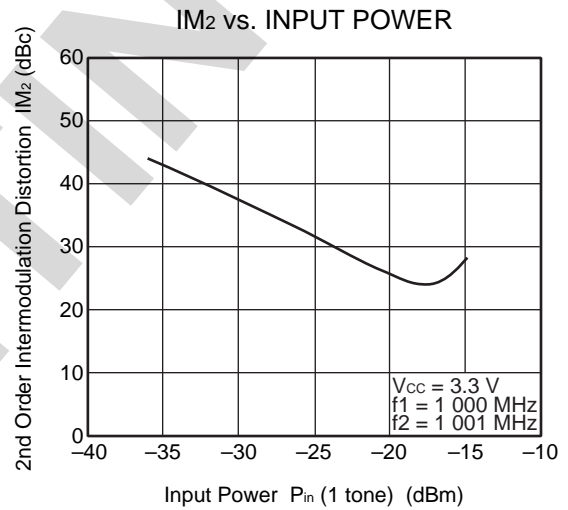
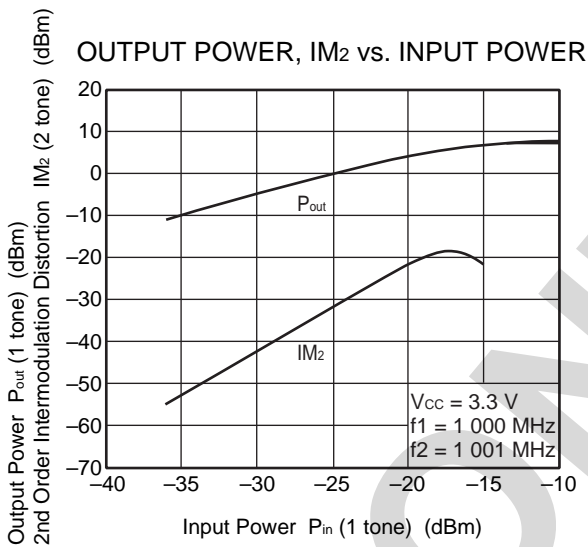
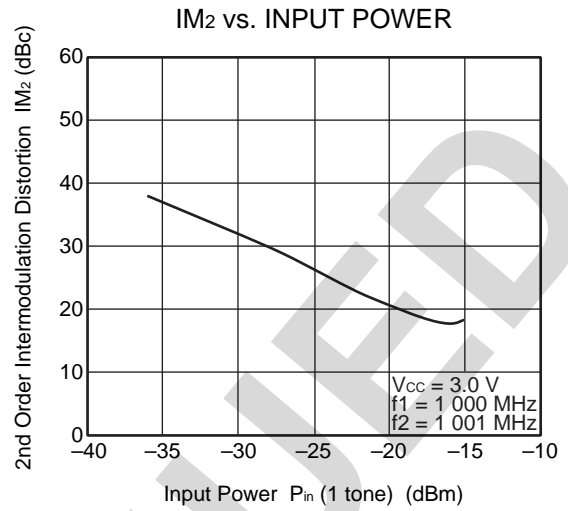
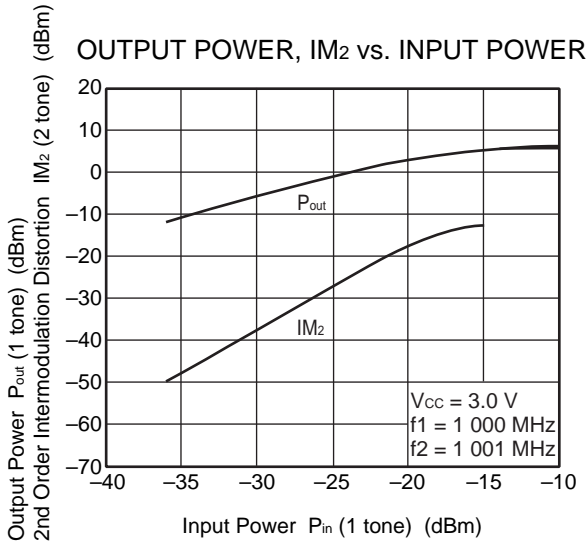

Remark The graphs indicate nominal characteristics.

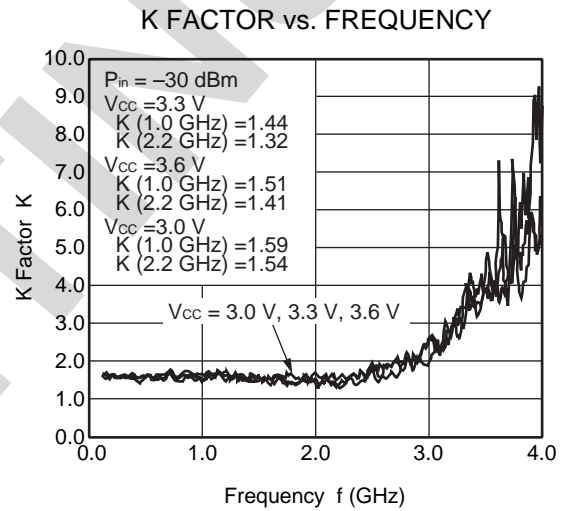
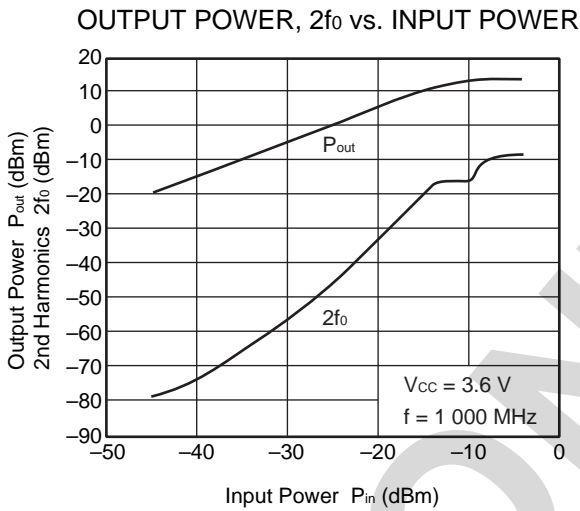
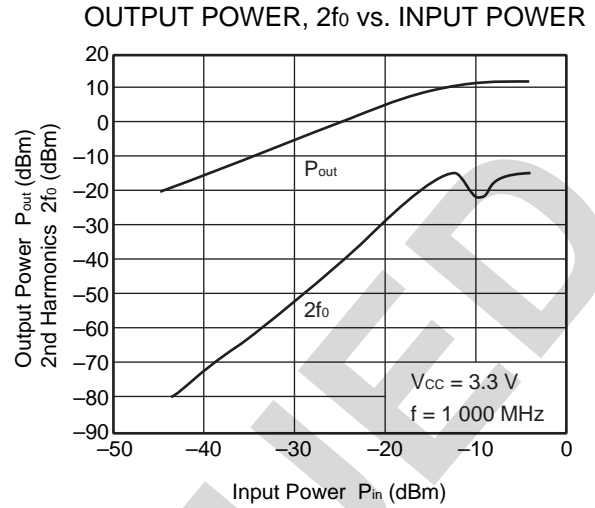
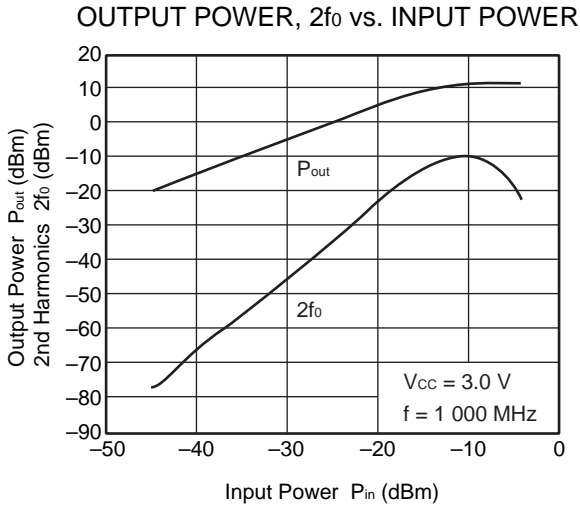

Remark The graphs indicate nominal characteristics.

S-PARAMETERS (T_A = +25°C, V_{CC} = V_{out} = 3.3 V, P_{in} = -30 dBm)

S₁₁-FREQUENCY

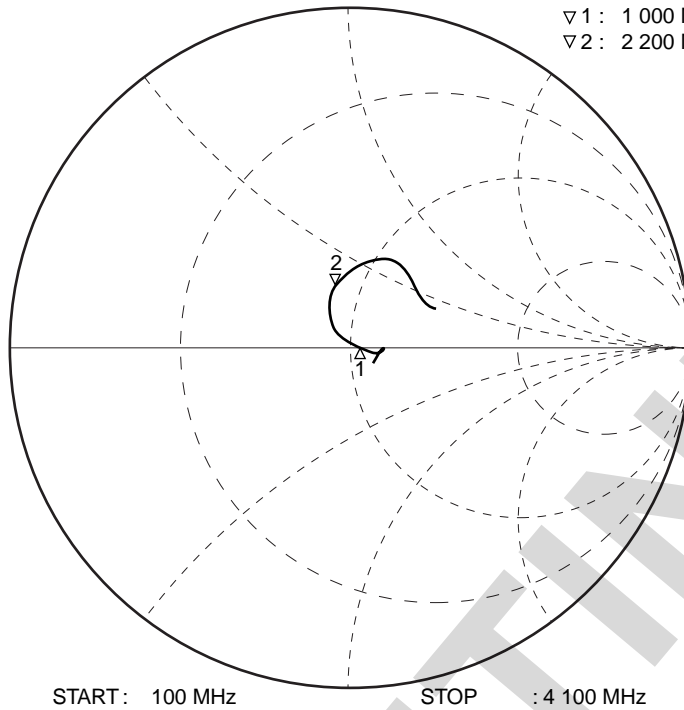

S₂₂-FREQUENCY

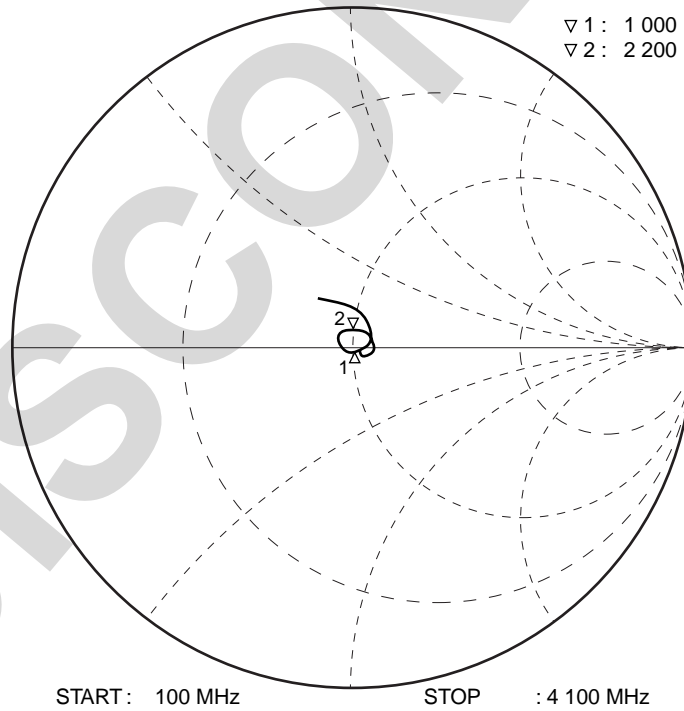

- Remarks 1.** Measured on the test circuit of evaluation board.
2. The graphs indicate nominal characteristics.

S-PARAMETERS

S-parameters and noise parameters are provided on our Web site in a format (S2P) that enables the direct import of the parameters to microwave circuit simulators without the need for keyboard inputs.

Click here to download S-parameters.

[RF and Microwave] → [Device Parameters]

URL <http://www.necel.com/microwave/en/>

DISCONTINUED

PACKAGE DIMENSIONS

6-PIN SUPER MINIMOLD (UNIT: mm)

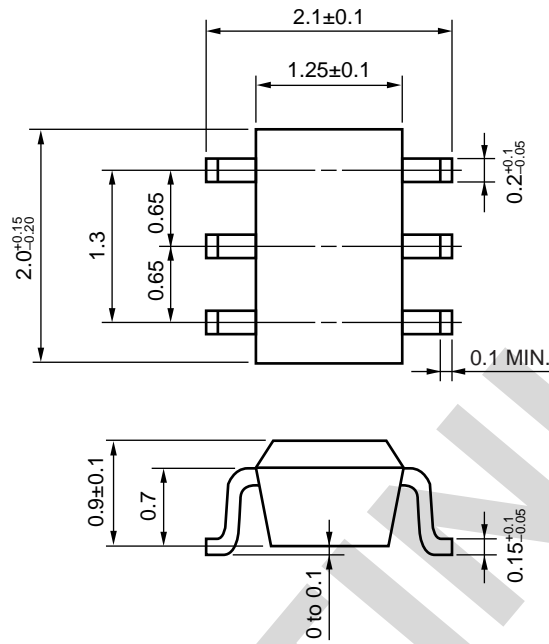

DISCONTINUED

NOTES ON CORRECT USE

- (1) Observe precautions for handling because of electro-static sensitive devices.
- (2) Form a ground pattern as widely as possible to minimize ground impedance (to prevent undesired oscillation).
All the ground terminals must be connected together with wide ground pattern to decrease impedance difference.
- (3) The bypass capacitor should be attached to the Vcc line.
- (4) The inductor (L) must be attached between Vcc and output pins. The inductance value should be determined in accordance with desired frequency.
- (5) The DC cut capacitor must be attached to input and output pin.

RECOMMENDED SOLDERING CONDITIONS

This product should be soldered and mounted under the following recommended conditions. For soldering methods and conditions other than those recommended below, contact your nearby sales office.

Soldering Method	Soldering Conditions	Condition Symbol
Infrared Reflow	Peak temperature (package surface temperature) : 260°C or below Time at peak temperature : 10 seconds or less Time at temperature of 220°C or higher : 60 seconds or less Preheating time at 120 to 180°C : 120±30 seconds Maximum number of reflow processes : 3 times Maximum chlorine content of rosin flux (% mass) : 0.2%(Wt.) or below	IR260
Wave Soldering	Peak temperature (molten solder temperature) : 260°C or below Time at peak temperature : 10 seconds or less Preheating temperature (package surface temperature) : 120°C or below Maximum number of flow processes : 1 time Maximum chlorine content of rosin flux (% mass) : 0.2%(Wt.) or below	WS260
Partial Heating	Peak temperature (terminal temperature) : 350°C or below Soldering time (per side of device) : 3 seconds or less Maximum chlorine content of rosin flux (% mass) : 0.2%(Wt.) or below	HS350

Caution Do not use different soldering methods together (except for partial heating).

• **The information in this document is current as of October, 2008. The information is subject to change without notice. For actual design-in, refer to the latest publications of NEC Electronics data sheets or data books, etc., for the most up-to-date specifications of NEC Electronics products. Not all products and/or types are available in every country. Please check with an NEC Electronics sales representative for availability and additional information.**

• No part of this document may be copied or reproduced in any form or by any means without the prior written consent of NEC Electronics. NEC Electronics assumes no responsibility for any errors that may appear in this document.

• NEC Electronics does not assume any liability for infringement of patents, copyrights or other intellectual property rights of third parties by or arising from the use of NEC Electronics products listed in this document or any other liability arising from the use of such products. No license, express, implied or otherwise, is granted under any patents, copyrights or other intellectual property rights of NEC Electronics or others.

• Descriptions of circuits, software and other related information in this document are provided for illustrative purposes in semiconductor product operation and application examples. The incorporation of these circuits, software and information in the design of a customer's equipment shall be done under the full responsibility of the customer. NEC Electronics assumes no responsibility for any losses incurred by customers or third parties arising from the use of these circuits, software and information.

• While NEC Electronics endeavors to enhance the quality, reliability and safety of NEC Electronics products, customers agree and acknowledge that the possibility of defects thereof cannot be eliminated entirely. To minimize risks of damage to property or injury (including death) to persons arising from defects in NEC Electronics products, customers must incorporate sufficient safety measures in their design, such as redundancy, fire-containment and anti-failure features.

• NEC Electronics products are classified into the following three quality grades: "Standard", "Special" and "Specific".

The "Specific" quality grade applies only to NEC Electronics products developed based on a customer-designated "quality assurance program" for a specific application. The recommended applications of an NEC Electronics product depend on its quality grade, as indicated below. Customers must check the quality grade of each NEC Electronics product before using it in a particular application.

"Standard": Computers, office equipment, communications equipment, test and measurement equipment, audio and visual equipment, home electronic appliances, machine tools, personal electronic equipment and industrial robots.

"Special": Transportation equipment (automobiles, trains, ships, etc.), traffic control systems, anti-disaster systems, anti-crime systems, safety equipment and medical equipment (not specifically designed for life support).

"Specific": Aircraft, aerospace equipment, submersible repeaters, nuclear reactor control systems, life support systems and medical equipment for life support, etc.

The quality grade of NEC Electronics products is "Standard" unless otherwise expressly specified in NEC Electronics data sheets or data books, etc. If customers wish to use NEC Electronics products in applications not intended by NEC Electronics, they must contact an NEC Electronics sales representative in advance to determine NEC Electronics' willingness to support a given application.

(Note)

(1) "NEC Electronics" as used in this statement means NEC Electronics Corporation and also includes its majority-owned subsidiaries.

(2) "NEC Electronics products" means any product developed or manufactured by or for NEC Electronics (as defined above).