



Bridgelux® Gen 8 V13 Array Series

Product Data Sheet DS413



Introduction

V Series



The V Series™ LED Array products deliver high quality light in a compact and cost-effective solid-state lighting package. These chip on board (CoB) arrays can be efficiently driven up to three times the nominal drive current, enabling design flexibility not previously possible. These high flux density light sources are designed to support a wide range of high quality, low cost directional luminaires and replacement lamps for both interior and exterior commercial and residential applications.

The V13 LED Array is available in a variety of electrical, CCT, and CRI combinations providing substantial design flexibility and energy efficiency advantages.

Lighting system designs incorporating these LED arrays deliver increased system level efficacy and a longer service life. Typical applications include replacement lamps and task, accent, spot, track, wide area, security, wall packs and down lights.

Features

- Efficacy of 178 lm/W typical, 3000K 80 CRI
- Reliable operation at up to 3x nominal current, 30% increase in maximum lumens per LES size
- Wide selection of CCT options (2700K-6500K) with minimum 70, 80 and 90 CRI options
- Uniform high-quality illumination
- 2 and 3 SDCM binning options (2700K – 4000K)
- Forward voltage bin codes and backside marking
- Instant light with unlimited dimming
- 5-Year warranty

Benefits

- Enables high efficiency lighting systems and lower operating costs
- Supports the trend toward luminaire miniaturization and delivers enhanced optical control
- Design flexibility for a broad range of lighting applications
- Clean white light without pixelation
- Uniform consistent white light
- Design flexibility for multi-source applications
- Easy to use with daylight and motion sensors to increase energy savings
- Design with confidence

Contents

Product Feature Map	2
Product Nomenclature	2
Product Selection Guide	3
Performance at Commonly Used Drive Currents	7
Electrical Characteristics	13
Eye Safety	14
Absolute Maximum Ratings	15
Performance Curves	16
Typical Radiation Pattern	18
Typical Color Spectrum	19
Mechanical Dimensions	20
Color Binning Information	21
Packaging and Labeling	22
Design Resources	24
Precautions	24
Disclaimers	24
About Bridgelux	25

Product Feature Map

Bridgelux arrays are fully engineered devices that provide consistent thermal and optical performance on an engineered mechanical platform. The V Series arrays are the most compact chip-on-board devices across all of

Bridgelux's LED Array products. The arrays incorporate several features to simplify design integration and assembly. Please visit www.bridgelux.com for more information on the V Series family of products.

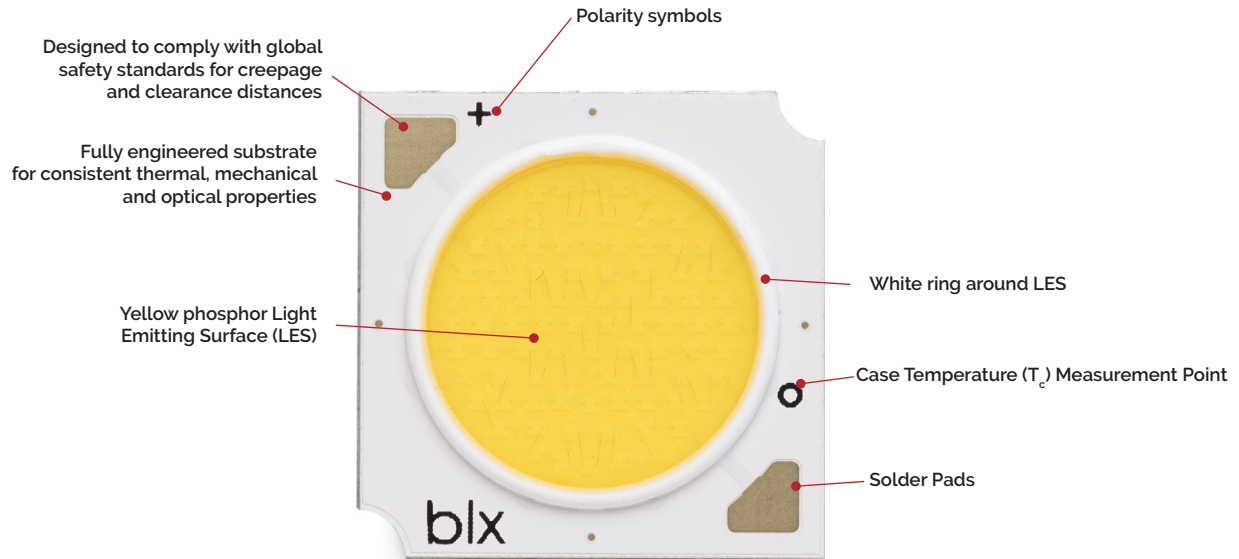

Note: Part number and lot codes are scribed on back of array

Product Nomenclature

The part number designation for Bridgelux V Series LED arrays is explained as follows:

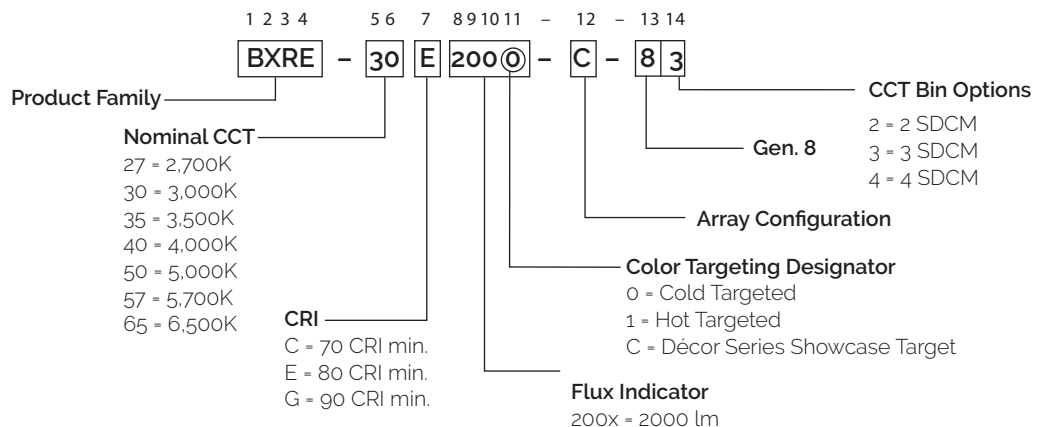

Product Selection Guide

The following product configurations are available:

Table 1: Selection Guide, Pulsed Measurement Data ($T_j = T_c = 25^\circ\text{C}$)

Part Number	Nominal CCT ¹ (K)	CRI ²	Nominal Drive Current ³ (mA)	Typical Pulsed Flux ^{4,5,6} $T_c = 25^\circ\text{C}$ (lm)	Minimum Pulsed Flux ^{6,7} $T_c = 25^\circ\text{C}$ (lm)	Typical V_f (V)	Typical Power (W)	Typical Efficacy (lm/W)
BXRE-27E2000-B-8x	2700	80	350	1963	1767	334	11.7	168
BXRE-27E2000-C-8x	2700	80	500	2805	2524	334	16.7	168
BXRE-27G2000-B-8x	2700	90	350	1620	1458	334	11.7	139
BXRE-27G2000-C-8x	2700	90	500	2314	2082	334	16.7	139
BXRE-27G20H0-B-8x	2700	90	350	1690	1521	334	11.7	145
BXRE-27G20H0-C-8x	2700	90	500	2414	2172	334	16.7	145
BXRE-30C2001-B-8x	3000	70	350	2184	1966	334	11.7	187
BXRE-30C2001-C-8x	3000	70	500	3120	2808	334	16.7	187
BXRE-30E2000-B-8x	3000	80	350	2086	1877	334	11.7	178
BXRE-30E2000-C-8x	3000	80	500	2980	2682	334	16.7	178
BXRE-30G2000-B-8x	3000	90	350	1693	1524	334	11.7	145
BXRE-30G2000-C-8x	3000	90	500	2419	2177	334	16.7	145
BXRE-30G20H0-B-8x	3000	90	350	1773	1596	334	11.7	152
BXRE-30G20H0-C-8x	3000	90	500	2533	2280	334	16.7	152
BXRE-35E2000-B-8x	3500	80	350	2135	1922	334	11.7	183
BXRE-35E2000-C-8x	3500	80	500	3050	2745	334	16.7	183
BXRE-35G2000-B-8x	3500	90	350	1755	1579	334	11.7	150
BXRE-35G2000-C-8x	3500	90	500	2507	2256	334	16.7	150
BXRE-40C2001-B-8x	4000	70	350	2246	2021	334	11.7	192
BXRE-40C2001-C-8x	4000	70	500	3208	2887	334	16.7	192
BXRE-40E2000-B-8x	4000	80	350	2147	1933	334	11.7	184
BXRE-40E2000-C-8x	4000	80	500	3068	2761	334	16.7	184
BXRE-40G2000-B-8x	4000	90	350	1792	1612	334	11.7	153
BXRE-40G2000-C-8x	4000	90	500	2559	2303	334	16.7	153
BXRE-50C2001-B-8x	5000	70	350	2258	2032	334	11.7	193
BXRE-50C2001-C-8x	5000	70	500	3225	2903	334	16.7	193
BXRE-50E2001-B-8x	5000	80	350	2172	1955	334	11.7	186
BXRE-50E2001-C-8x	5000	80	500	3103	2792	334	16.7	186
BXRE-50G2001-B-8x	5000	90	350	1877	1690	334	11.7	161
BXRE-50G2001-C-8x	5000	90	500	2682	2414	334	16.7	161
BXRE-57C2001-B-8x	5700	70	350	2196	1977	334	11.7	188
BXRE-57C2001-C-8x	5700	70	500	3138	2824	334	16.7	188

Notes for Table 1:

- Nominal CCT as defined by ANSI C78.377-2011. Products with a CCT of 5000K-6500K are hot targeted to $T_c = 85^\circ\text{C}$.
- CRI values are minimums for all other products. Minimum Rg value for 80 CRI products is 0, the minimum Rg values for 90 CRI products is 50, the minimum Rg values for 97 CRI products is 93. Bridgelux maintains a ± 3 tolerance on Rg values.
- Drive current is referred to as nominal drive current.
- Products tested under pulsed condition (10ms pulse width) at nominal test current where T_j (junction temperature) = T_c (case temperature) = 25°C .
- Typical performance values are provided as a reference only and are not a guarantee of performance.
- Bridgelux maintains a $\pm 7\%$ tolerance on flux measurements.
- Minimum flux values at the nominal test current are guaranteed by 100% test.

Product Selection Guide

The following product configurations are available:

Table 1: Selection Guide, Pulsed Measurement Data ($T_j = T_c = 25^\circ\text{C}$)

Part Number	Nominal CCT ¹ (K)	CRI ²	Nominal Drive Current ³ (mA)	Typical Pulsed Flux ^{4,5,6} $T_c = 25^\circ\text{C}$ (lm)	Minimum Pulsed Flux ^{6,7} $T_c = 25^\circ\text{C}$ (lm)	Typical V_f (V)	Typical Power (W)	Typical Efficacy (lm/W)
BXRE-57E2001-B-8x	5700	80	350	2086	1877	33.4	11.7	178
BXRE-57E2001-C-8x	5700	80	500	2980	2682	33.4	16.7	178
BXRE-65C2001-B-8x	6500	70	350	2196	1977	33.4	11.7	188
BXRE-65C2001-C-8x	6500	70	500	3138	2824	33.4	16.7	188
BXRE-65E2001-B-8x	6500	80	350	2111	1899	33.4	11.7	181
BXRE-65E2001-C-8x	6500	80	500	3015	2714	33.4	16.7	181

Notes for Table 1:

- Nominal CCT as defined by ANSI C78.377-2011. Products with a CCT of 5000K-6500K are hot targeted to $T_c = 85^\circ\text{C}$.
- CRI values are typical for Decor Series Ultra, Décor Series Street and Landmark and Decor Series Class A products. CRI values are minimums for all other products. Minimum Rg value for 80 CRI products is 0, the minimum Rg values for 90 CRI products is 50, the minimum Rg values for 97 CRI products is 93. Bridgelux maintains a ± 3 tolerance on Rg values.
- Drive current is referred to as nominal drive current.
- Products tested under pulsed condition (10ms pulse width) at nominal test current where T_j (junction temperature) = T_c (case temperature) = 25°C .
- Typical performance values are provided as a reference only and are not a guarantee of performance.
- Bridgelux maintains a $\pm 7\%$ tolerance on flux measurements.
- Minimum flux values at the nominal test current are guaranteed by 100% test.

Product Selection Guide

Table 2: Selection Guide, Stabilized DC Performance ($T_c = 85^\circ\text{C}$)^{4,5}

Part Number	Nominal CCT ¹ (K)	CRI ²	Nominal Drive Current ³ (mA)	Typical DC Flux ^{4,5} $T_c = 85^\circ\text{C}$ (lm)	Minimum DC Flux ⁶ $T_c = 85^\circ\text{C}$ (lm)	Typical V_f (V)	Typical Power (W)	Typical Efficacy (lm/W)
BXRE-27E2000-B-8x	2700	80	350	1767	1590	32.7	11.4	154
BXRE-27E2000-C-8x	2700	80	500	2524	2272	32.7	16.3	154
BXRE-27G2000-B-8x	2700	90	350	1458	1312	32.7	11.4	127
BXRE-27G2000-C-8x	2700	90	500	2082	1874	32.7	16.3	127
BXRE-27G20Ho-B-8x	2700	90	350	1521	1369	32.7	11.4	133
BXRE-27G20Ho-C-8x	2700	90	500	2172	1955	32.7	16.3	133
BXRE-30C2001-B-8x	3000	70	350	1966	1769	32.7	11.4	172
BXRE-30C2001-C-8x	3000	70	500	2808	2527	32.7	16.3	172
BXRE-30E2000-B-8x	3000	80	350	1877	1690	32.7	11.4	164
BXRE-30E2000-C-8x	3000	80	500	2682	2414	32.7	16.3	164
BXRE-30G2000-B-8x	3000	90	350	1524	1372	32.7	11.4	133
BXRE-30G2000-C-8x	3000	90	500	2177	1959	32.7	16.3	133
BXRE-30G20Ho-B-8x	3000	90	350	1596	1436	32.7	11.4	140
BXRE-30G20Ho-C-8x	3000	90	500	2280	2052	32.7	16.3	140
BXRE-35E2000-B-8x	3500	80	350	1922	1729	32.7	11.4	168
BXRE-35E2000-C-8x	3500	80	500	2745	2471	32.7	16.3	168
BXRE-35G2000-B-8x	3500	90	350	1579	1421	32.7	11.4	138
BXRE-35G2000-C-8x	3500	90	500	2256	2030	32.7	16.3	138
BXRE-40C2001-B-8x	4000	70	350	2021	1819	32.7	11.4	177
BXRE-40C2001-C-8x	4000	70	500	2887	2598	32.7	16.3	177
BXRE-40E2000-B-8x	4000	80	350	1933	1739	32.7	11.4	169
BXRE-40E2000-C-8x	4000	80	500	2761	2485	32.7	16.3	169
BXRE-40G2000-B-8x	4000	90	350	1612	1451	32.7	11.4	141
BXRE-40G2000-C-8x	4000	90	500	2303	2073	32.7	16.3	141
BXRE-50C2001-B-8x	5000	70	350	2032	1829	32.7	11.4	178
BXRE-50C2001-C-8x	5000	70	500	2903	2613	32.7	16.3	178
BXRE-50E2001-B-8x	5000	80	350	1955	1759	32.7	11.4	171
BXRE-50E2001-C-8x	5000	80	500	2792	2513	32.7	16.3	171
BXRE-50G2001-B-8x	5000	90	350	1690	1521	32.7	11.4	148
BXRE-50G2001-C-8x	5000	90	500	2414	2172	32.7	16.3	148
BXRE-57C2001-B-8x	5700	70	350	1977	1779	32.7	11.4	173
BXRE-57C2001-C-8x	5700	70	500	2824	2542	32.7	16.3	173

Notes for Table 2:

- Nominal CCT as defined by ANSI C78.377-2011. Products with a CCT of 5000K-6500K are hot targeted to $T_c = 85^\circ\text{C}$.
- CRI values are minimums for all other products. Minimum Rg value for 80 CRI products is 0, the minimum Rg values for 90 CRI products is 50. Bridgelux maintains a ± 3 tolerance on Rg values.
- Drive current is referred to as nominal drive current.
- Typical stabilized DC performance values are provided as reference only and are not a guarantee of performance.
- Typical performance is estimated based on operation under DC (direct current) with LED array mounted onto a heat sink with thermal interface material and the case temperature maintained at 85°C . Based on Bridgelux test setup, values may vary depending on the thermal design of the luminaire and/or the exposed environment to which the product is subjected.
- Minimum flux values at elevated temperatures are provided for reference only and are not guaranteed by 100% production testing. Based on Bridgelux test setup, values may vary depending on the thermal design of the luminaire and/or the exposed environment to which the product is subjected.

Product Selection Guide

Table 2: Selection Guide, Stabilized DC Performance ($T_c = 85^\circ\text{C}$)^{4,5} (continued)

Part Number	Nominal CCT ¹ (K)	CRI ²	Nominal Drive Current ³ (mA)	Typical DC Flux ^{4,5} $T_c = 85^\circ\text{C}$ (lm)	Minimum DC Flux ⁶ $T_c = 85^\circ\text{C}$ (lm)	Typical V_f (V)	Typical Power (W)	Typical Efficacy (lm/W)
BXRE-57E2001-B-8x	5700	80	350	1877	1690	32.7	11.4	164
BXRE-57E2001-C-8x	5700	80	500	2682	2414	32.7	16.3	164
BXRE-65C2001-B-8x	6500	70	350	1977	1779	32.7	11.4	173
BXRE-65C2001-C-8x	6500	70	500	2824	2542	32.7	16.3	173
BXRE-65E2001-B-8x	6500	80	350	1899	1710	32.7	11.4	166
BXRE-65E2001-C-8x	6500	80	500	2714	2442	32.7	16.3	166

Notes for Table 2:

- Nominal CCT as defined by ANSI C78.377-2011. Products with a CCT of 5000K-6500K are hot targeted to $T_c = 85^\circ\text{C}$.
- CRI values are minimums for all products. Minimum Rg value for 80 CRI products is 0, the minimum Rg values for 90 CRI products is 50. Bridgelux maintains a ± 3 tolerance on Rg values.
- Drive current is referred to as nominal drive current.
- Typical stabilized DC performance values are provided as reference only and are not a guarantee of performance.
- Typical performance is estimated based on operation under DC (direct current) with LED array mounted onto a heat sink with thermal interface material and the case temperature maintained at 85°C . Based on Bridgelux test setup, values may vary depending on the thermal design of the luminaire and/or the exposed environment to which the product is subjected.
- Minimum flux values at elevated temperatures are provided for reference only and are not guaranteed by 100% production testing. Based on Bridgelux test setup, values may vary depending on the thermal design of the luminaire and/or the exposed environment to which the product is subjected.

Performance at Commonly Used Drive Currents

V Series LED arrays are tested to the specifications shown using the nominal drive currents in Table 1. V Series may also be driven at other drive currents dependent on specific application design requirements. The performance at any drive current can be derived from the current vs. voltage characteristics shown in Figures 1 & 2 and the flux vs. current characteristics shown in Figures 3 & 4. The performance at commonly used drive currents is summarized in Table 3.

Table 3: Product Performance at Commonly Used Drive Currents

Part Number	CRI	Drive Current ¹ (mA)	Typical V _f T _c = 25°C (V)	Typical Power T _c = 25°C (W)	Typical Flux ² T _c = 25°C (lm)	Typical DC Flux ³ T _c = 85°C (lm)	Typical Efficacy T _c = 25°C (lm/W)
BXRE-27E2000-B-8x	80	175	32.4	5.7	1019	917	179
		260	32.9	8.6	1476	1329	173
		350	33.4	11.7	1963	1767	168
		450	33.9	15.3	2478	2230	162
		700	35.2	24.6	3750	3375	152
		1250	37.6	47.0	6363	5727	135
BXRE-27E2000-C-8x	80	250	32.5	8.1	1455	1310	179
		375	33.0	12.4	2128	1916	172
		500	33.4	16.7	2805	2524	168
		630	33.9	21.4	3473	3126	163
		1000	35.2	35.2	5357	4821	152
		1750	37.5	65.7	8928	8035	136
BXRE-27G2000-B-8x	90	175	32.4	5.7	840	756	148
		260	32.9	8.6	1218	1096	142
		350	33.4	11.7	1620	1458	139
		450	33.9	15.3	2044	1840	134
		700	35.2	24.6	3094	2784	126
		1250	37.6	47.0	5250	4725	112
BXRE-27G2000-C-8x	90	250	32.5	8.1	1200	1080	148
		375	33.0	12.4	1756	1580	142
		500	33.4	16.7	2314	2082	138
		630	33.9	21.4	2866	2579	134
		1000	35.2	35.2	4420	3978	126
		1750	37.5	65.7	7366	6629	112
BXRE-27G20H0-B-8x	90	175	32.4	5.7	877	789	154
		260	32.9	8.6	1271	1144	149
		350	33.4	11.7	1690	1521	145
		450	33.9	15.3	2133	1920	140
		700	35.2	24.6	3227	2905	131
		1250	37.6	47.0	5476	4929	117
BXRE-27G20H0-C-8x	90	250	32.5	8.1	1252	1127	154
		375	33.0	12.4	1832	1649	148
		500	33.4	16.7	2414	2172	144
		630	33.9	21.4	2989	2690	140
		1000	35.2	35.2	4610	4149	131
		1750	37.5	65.7	7684	6916	117

Notes for Table 3:

1. Alternate drive currents in Table 3 are provided for reference only and are not a guarantee of performance.
2. Bridgelux maintains a ± 7% tolerance on flux measurements.
3. Typical stabilized DC performance values are provided as reference only and are not a guarantee of performance.

Performance at Commonly Used Drive Currents

Table 3: Product Performance at Commonly Used Drive Currents (Continued)

Part Number	CRI	Drive Current ¹ (mA)	Typical V_f $T_c = 25^\circ\text{C}$ (V)	Typical Power $T_c = 25^\circ\text{C}$ (W)	Typical Flux ² $T_c = 25^\circ\text{C}$ (lm)	Typical DC Flux ³ $T_c = 85^\circ\text{C}$ (lm)	Typical Efficacy $T_c = 25^\circ\text{C}$ (lm/W)
BXRE-30C2001-B-8x	70	175	32.4	5.7	1133	1020	200
		260	32.9	8.6	1643	1478	192
		350	33.4	11.7	2184	1966	187
		450	33.9	15.3	2757	2481	181
		700	35.2	24.6	4172	3755	169
		1250	37.6	47.0	7079	6371	151
BXRE-30C2001-C-8x	70	250	32.5	8.1	1619	1457	199
		375	33.0	12.4	2368	2131	192
		500	33.4	16.7	3120	2808	187
		630	33.9	21.4	3864	3478	181
		1000	35.2	35.2	5960	5364	169
		1750	37.5	65.7	9933	8939	151
BXRE-30E2000-B-8x	80	175	32.4	5.7	1082	974	191
		260	32.9	8.6	1569	1412	183
		350	33.4	11.7	2086	1877	178
		450	33.9	15.3	2633	2370	172
		700	35.2	24.6	3984	3586	162
		1250	37.6	47.0	6761	6085	144
BXRE-30E2000-C-8x	80	250	32.5	8.1	1546	1391	190
		375	33.0	12.4	2261	2035	183
		500	33.4	16.7	2980	2682	178
		630	33.9	21.4	3691	3321	173
		1000	35.2	35.2	5692	5123	162
		1750	37.5	65.7	9486	8538	144
BXRE-30G2000-B-8x	90	175	32.4	5.7	878	791	155
		260	32.9	8.6	1273	1146	149
		350	33.4	11.7	1693	1524	145
		450	33.9	15.3	2137	1924	140
		700	35.2	24.6	3234	2911	131
		1250	37.6	47.0	5488	4939	117
BXRE-30G2000-C-8x	90	250	32.5	8.1	1255	1129	155
		375	33.0	12.4	1836	1652	149
		500	33.4	16.7	2419	2177	145
		630	33.9	21.4	2996	2696	140
		1000	35.2	35.2	4621	4158	131
		1750	37.5	65.7	7701	6931	117
BXRE-30G20H0-B-8x	90	175	32.4	5.7	920	828	162
		260	32.9	8.6	1333	1200	156
		350	33.4	11.7	1773	1596	152
		450	33.9	15.3	2238	2014	147
		700	35.2	24.6	3387	3048	138
		1250	37.6	47.0	5747	5172	122

Notes for Table 3:

1. Alternate drive currents in Table 3 are provided for reference only and are not a guarantee of performance.
2. Bridgelux maintains a $\pm 7\%$ tolerance on flux measurements.
3. Typical stabilized DC performance values are provided as reference only and are not a guarantee of performance.

Performance at Commonly Used Drive Currents

Table 3: Product Performance at Commonly Used Drive Currents (Continued)

Part Number	CRI	Drive Current ¹ (mA)	Typical V _f T _c = 25°C (V)	Typical Power T _c = 25°C (W)	Typical Flux ² T _c = 25°C (lm)	Typical DC Flux ³ T _c = 85°C (lm)	Typical Efficacy T _c = 25°C (lm/W)
BXRE-30G20H0-C-8x	90	250	32.5	8.1	1314	1183	162
		375	33.0	12.4	1922	1730	156
		500	33.4	16.7	2533	2280	152
		630	33.9	21.4	3137	2823	147
		1000	35.2	35.2	4838	4354	137
		1750	37.5	65.7	8063	7257	123
BXRE-35E2000-B-8x	80	175	32.4	5.7	1108	997	195
		260	32.9	8.6	1606	1445	188
		350	33.4	11.7	2135	1922	183
		450	33.9	15.3	2695	2426	177
		700	35.2	24.6	4078	3670	166
		1250	37.6	47.0	6920	6228	147
BXRE-35E2000-C-8x	80	250	32.5	8.1	1582	1424	195
		375	33.0	12.4	2315	2083	187
		500	33.4	16.7	3050	2745	182
		630	33.9	21.4	3777	3400	177
		1000	35.2	35.2	5826	5243	165
		1750	37.5	65.7	9710	8739	148
BXRE-35G2000-B-8x	90	175	32.4	5.7	910	819	160
		260	32.9	8.6	1320	1188	154
		350	33.4	11.7	1755	1579	150
		450	33.9	15.3	2215	1993	145
		700	35.2	24.6	3352	3016	136
		1250	37.6	47.0	5687	5118	121
BXRE-35G2000-C-8x	90	250	32.5	8.1	1300	1170	160
		375	33.0	12.4	1902	1712	154
		500	33.4	16.7	2507	2256	150
		630	33.9	21.4	3104	2794	145
		1000	35.2	35.2	4788	4309	136
		1750	37.5	65.7	7980	7182	121
BXRE-40C2001-B-8x	70	175	32.4	5.7	1165	1048	205
		260	32.9	8.6	1689	1520	197
		350	33.4	11.7	2246	2021	192
		450	33.9	15.3	2834	2551	186
		700	35.2	24.6	4289	3860	174
		1250	37.6	47.0	7278	6550	155
BXRE-40C2001-C-8x	70	250	32.5	8.1	1664	1498	205
		375	33.0	12.4	2434	2191	197
		500	33.4	16.7	3208	2887	192
		630	33.9	21.4	3973	3575	186
		1000	35.2	35.2	6127	5514	174
		1750	37.5	65.7	10212	9191	155

Notes for Table 3:

1. Alternate drive currents in Table 3 are provided for reference only and are not a guarantee of performance.
2. Bridgelux maintains a ± 7% tolerance on flux measurements.
3. Typical stabilized DC performance values are provided as reference only and are not a guarantee of performance.

Performance at Commonly Used Drive Currents

Table 3: Product Performance at Commonly Used Drive Currents (Continued)

Part Number	CRI	Drive Current ¹ (mA)	Typical V _f T _c = 25°C (V)	Typical Power T _c = 25°C (W)	Typical Flux ² T _c = 25°C (lm)	Typical DC Flux ³ T _c = 85°C (lm)	Typical Efficacy T _c = 25°C (lm/W)
BXRE-40E2000-B-8x	80	175	32.4	5.7	1114	1003	196
		260	32.9	8.6	1615	1453	189
		350	33.4	11.7	2147	1933	184
		450	33.9	15.3	2711	2439	178
		700	35.2	24.6	4102	3691	167
		1250	37.6	47.0	6960	6264	148
BXRE-40E2000-C-8x	80	250	32.5	8.1	1591	1432	196
		375	33.0	12.4	2328	2095	188
		500	33.4	16.7	3068	2761	184
		630	33.9	21.4	3799	3419	178
		1000	35.2	35.2	5859	5273	166
		1750	37.5	65.7	9765	8789	149
BXRE-40G2000-B-8x	90	175	32.4	5.7	929	836	164
		260	32.9	8.6	1347	1213	157
		350	33.4	11.7	1792	1612	153
		450	33.9	15.3	2261	2035	148
		700	35.2	24.6	3422	3080	139
		1250	37.6	47.0	5806	5226	124
BXRE-40G2000-C-8x	90	250	32.5	8.1	1328	1195	164
		375	33.0	12.4	1942	1748	157
		500	33.4	16.7	2559	2303	153
		630	33.9	21.4	3170	2853	148
		1000	35.2	35.2	4888	4400	139
		1750	37.5	65.7	8147	7332	124
BXRE-50C2001-B-8x	70	175	32.4	5.7	1171	1054	206
		260	32.9	8.6	1698	1528	198
		350	33.4	11.7	2258	2032	193
		450	33.9	15.3	2850	2565	187
		700	35.2	24.6	4312	3881	175
		1250	37.6	47.0	7318	6586	156
BXRE-50C2001-C-8x	70	250	32.5	8.1	1673	1506	206
		375	33.0	12.4	2448	2203	198
		500	33.4	16.7	3225	2903	193
		630	33.9	21.4	3994	3595	187
		1000	35.2	35.2	6161	5545	175
		1750	37.5	65.7	10268	9241	156
BXRE-50E2001-B-8x	80	175	32.4	5.7	1127	1014	198
		260	32.9	8.6	1633	1470	191
		350	33.4	11.7	2172	1955	186
		450	33.9	15.3	2741	2467	180
		700	35.2	24.6	4148	3734	168
		1250	37.6	47.0	7039	6335	150

Notes for Table 3:

1. Alternate drive currents in Table 3 are provided for reference only and are not a guarantee of performance.
2. Bridgelux maintains a ± 7% tolerance on flux measurements.
3. Typical stabilized DC performance values are provided as reference only and are not a guarantee of performance.

Performance at Commonly Used Drive Currents

Table 3: Product Performance at Commonly Used Drive Currents (Continued)

Part Number	CRI	Drive Current ¹ (mA)	Typical V _f T _c = 25°C (V)	Typical Power T _c = 25°C (W)	Typical Flux ² T _c = 25°C (lm)	Typical DC Flux ³ T _c = 85°C (lm)	Typical Efficacy T _c = 25°C (lm/W)
BXRE-50E2001-C-8x	80	250	32.5	8.1	1610	1449	198
		375	33.0	12.4	2355	2119	190
		500	33.4	16.7	3103	2792	186
		630	33.9	21.4	3842	3458	180
		1000	35.2	35.2	5926	5334	168
		1750	37.5	65.7	9877	8889	150
BXRE-50G2001-B-8x	90	175	32.4	5.7	974	877	172
		260	32.9	8.6	1412	1271	165
		350	33.4	11.7	1877	1690	161
		450	33.9	15.3	2370	2133	155
		700	35.2	24.6	3586	3227	146
		1250	37.6	47.0	6085	5476	129
BXRE-50G2001-C-8x	90	250	32.5	8.1	1391	1252	171
		375	33.0	12.4	2035	1832	165
		500	33.4	16.7	2682	2414	160
		630	33.9	21.4	3321	2989	155
		1000	35.2	35.2	5123	4610	145
		1750	37.5	65.7	8538	7684	130
BXRE-57C2001-B-8x	70	175	32.4	5.7	1139	1026	201
		260	32.9	8.6	1652	1487	193
		350	33.4	11.7	2196	1977	188
		450	33.9	15.3	2772	2495	182
		700	35.2	24.6	4195	3776	170
		1250	37.6	47.0	7119	6407	151
BXRE-57C2001-C-8x	70	250	32.5	8.1	1628	1465	200
		375	33.0	12.4	2381	2143	193
		500	33.4	16.7	3138	2824	188
		630	33.9	21.4	3886	3497	182
		1000	35.2	35.2	5993	5394	170
		1750	37.5	65.7	9989	8990	152
BXRE-57E2001-B-8x	80	175	32.4	5.7	1082	974	191
		260	32.9	8.6	1569	1412	183
		350	33.4	11.7	2086	1877	178
		450	33.9	15.3	2633	2370	172
		700	35.2	24.6	3984	3586	162
		1250	37.6	47.0	6761	6085	144
BXRE-57E2001-C-8x	80	250	32.5	8.1	1546	1391	190
		375	33.0	12.4	2261	2035	183
		500	33.4	16.7	2980	2682	178
		630	33.9	21.4	3691	3321	173
		1000	35.2	35.2	5692	5123	162
		1750	37.5	65.7	9486	8538	144

Notes for Table 3:

1. Alternate drive currents in Table 3 are provided for reference only and are not a guarantee of performance.
2. Bridgelux maintains a ± 7% tolerance on flux measurements.
3. Typical stabilized DC performance values are provided as reference only and are not a guarantee of performance.

Performance at Commonly Used Drive Currents

Table 3: Product Performance at Commonly Used Drive Currents (Continued)

Part Number	CRI	Drive Current ¹ (mA)	Typical V_f $T_c = 25^\circ\text{C}$ (V)	Typical Power $T_c = 25^\circ\text{C}$ (W)	Typical Flux ² $T_c = 25^\circ\text{C}$ (lm)	Typical DC Flux ³ $T_c = 85^\circ\text{C}$ (lm)	Typical Efficacy $T_c = 25^\circ\text{C}$ (lm/W)
BXRE-65C2001-B-8x	70	175	32.4	5.7	1139	1026	201
		260	32.9	8.6	1652	1487	193
		350	33.4	11.7	2196	1977	188
		450	33.9	15.3	2772	2495	182
		700	35.2	24.6	4195	3776	170
		1250	37.6	47.0	7119	6407	151
BXRE-65C2001-C-8x	70	250	32.5	8.1	1628	1465	200
		375	33.0	12.4	2381	2143	193
		500	33.4	16.7	3138	2824	188
		630	33.9	21.4	3886	3497	182
		1000	35.2	35.2	5993	5394	170
		1750	37.5	65.7	9989	8990	152
BXRE-65E2001-B-8x	80	175	32.4	5.7	1095	985	193
		260	32.9	8.6	1587	1428	185
		350	33.4	11.7	2111	1899	181
		450	33.9	15.3	2664	2398	175
		700	35.2	24.6	4031	3628	164
		1250	37.6	47.0	6840	6156	146
BXRE-65E2001-C-8x	80	250	32.5	8.1	1564	1408	193
		375	33.0	12.4	2288	2059	185
		500	33.4	16.7	3015	2714	180
		630	33.9	21.4	3734	3361	175
		1000	35.2	35.2	5759	5183	164
		1750	37.5	65.7	9598	8638	146

Notes for Table 3:

1. Alternate drive currents in Table 3 are provided for reference only and are not a guarantee of performance.
2. Bridgelux maintains a $\pm 7\%$ tolerance on flux measurements.
3. Typical stabilized DC performance values are provided as reference only and are not a guarantee of performance.

Electrical Characteristics

Table 4: Electrical Characteristics

Part Number	Drive Current (mA)	Forward Voltage Pulsed, $T_c = 25^\circ\text{C}$ (V) ^{1, 2, 3, 8}			Typical Coefficient of Forward Voltage ⁴ $\Delta V_f / \Delta T_c$ (mV/ $^\circ\text{C}$)	Typical Thermal Resistance Junction to Case ^{5,6} R_{j-c} ($^\circ\text{C}/\text{W}$)	Driver Selection Voltages ⁷ (V)	
		Minimum	Typical	Maximum			V_f Min. Hot $T_c = 105^\circ\text{C}$ (V)	V_f Max. Cold $T_c = -40^\circ\text{C}$ (V)
BXRE-xxx200x-B-8x	350	30.9	33.4	35.9	-10.77	0.22	30.0	36.6
	1250	34.8	37.6	40.4	-12.13	0.34	33.8	41.2
BXRE-xxx200x-C-8x	500	30.9	33.4	35.9	-10.77	0.19	30.0	36.6
	1750	34.7	37.5	40.3	-12.10	0.29	33.7	41.1

Notes for Table 4:

- Parts are tested in pulsed conditions, $T_c = 25^\circ\text{C}$. Pulse width is 10ms.
- Voltage minimum and maximum are provided for reference only and are not a guarantee of performance.
- Bridgelux maintains a tester tolerance of $\pm 0.10\text{V}$ on forward voltage measurements.
- Typical coefficient of forward voltage tolerance is $\pm 0.1\text{mV}$ for nominal current.
- Thermal resistance values are based from test data of a 3000K 80 CRI product.
- Thermal resistance value was calculated using total electrical input power; optical power was not subtracted from input power. The thermal interface material used during testing is not included in the thermal resistance value.
- V_f min hot and max cold values are provided as reference only and are not guaranteed by test. These values are provided to aid in driver design and selection over the operating range of the product.
- This product has been designed and manufactured per IEC 62031:2014. This product has passed dielectric withstand voltage testing at 1140 V. The working voltage designated for the insulation is 70V d.c. The maximum allowable voltage across the array must be determined in the end product application.

Eye Safety

Table 5: Eye Safety Risk Group (RG) Classifications

Part Number	Drive Current (mA)	CCT			
		2700K/3000K	4000K ²	5000K ³	6500K ⁴
BXRE-xxx200x-B-8x	800	RG1	RG1	RG1	RG1
	1110	RG1	RG1	RG1	RG2
	1250	RG1	RG1	RG2	RG2
BXRE-xxx200x-C-8x	800	RG1	RG1	RG1	RG1
	1110	RG1	RG1	RG1	RG2
	1470	RG1	RG1	RG2	RG2
	1750	RG1	RG2	RG2	RG2

Notes for Table 5:

1. Eye safety classification for the use of Bridgelux V Series LED arrays is in accordance with specification IEC/TR 62778: Application of IEC 62471 for the assessment of blue light hazard to light sources and luminaires.
2. For products classified as RG2 at 4000K, Ethr= 1980 lx.
3. For products classified as RG2 at 5000K Ethr= 1530 lx.
4. For products classified as RG2 at 6500K, Ethr= 1170 lx.
5. Please contact your Bridgelux sales representative for Ethr values at specific drive currents and CCTs not listed.

Absolute Maximum Ratings

Table 6: Maximum Ratings

Parameter	Maximum Rating	
LED Junction Temperature (T_j)	150°C	
Storage Temperature	-40°C to +105°C	
Operating Case Temperature ¹ (T_c)	105°C	
Soldering Temperature ²	300°C or lower for a maximum of 6 seconds	
	BXRE-xxx200x-B-8x	BXRE-xxx200x-C-8x
Maximum Drive Current ³	1250 mA	1750 mA
Maximum Peak Pulsed Drive Current ⁴	1400 mA	1960 mA
Maximum Reverse Voltage ⁵	-60V	-60V

Notes for Table 6:

1. For IEC 62717 requirement, please consult your Bridgelux sales representative.
2. Refer to Bridgelux Application Note AN101: Handling and Assembly of Bridgelux V Series LED Arrays
3. Arrays may be driven at higher currents however lumen maintenance may be reduced and warranty will not apply.
4. Bridgelux recommends a maximum duty cycle of 10% and pulse width of 20 ms when operating LED Arrays at maximum peak pulsed current specified. Maximum peak pulsed currents indicate values where LED Arrays can be driven without catastrophic failures.
5. Light emitting diodes are not designed to be driven in reverse voltage and will not produce light under this condition. Maximum rating provided for reference only.

Performance Curves

Figure 1: V13B Drive Current vs. Voltage

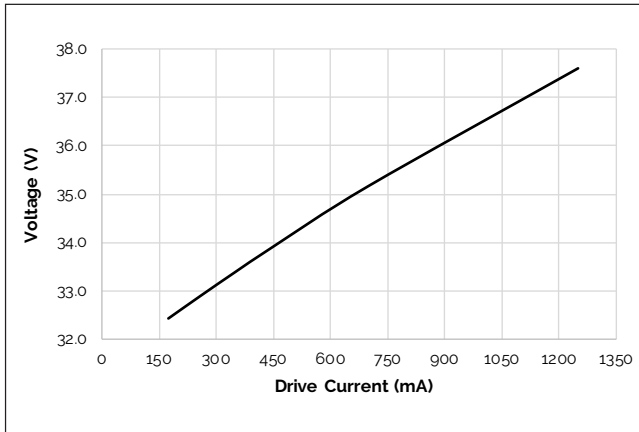

Figure 2: V13C Drive Current vs. Voltage

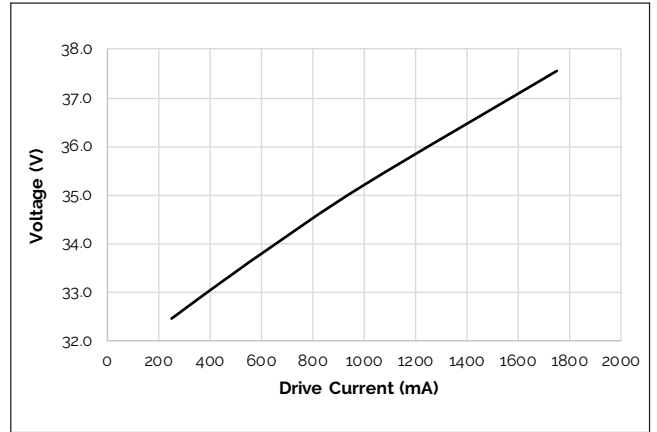

Figure 3: V13B Drive Current vs. Voltage

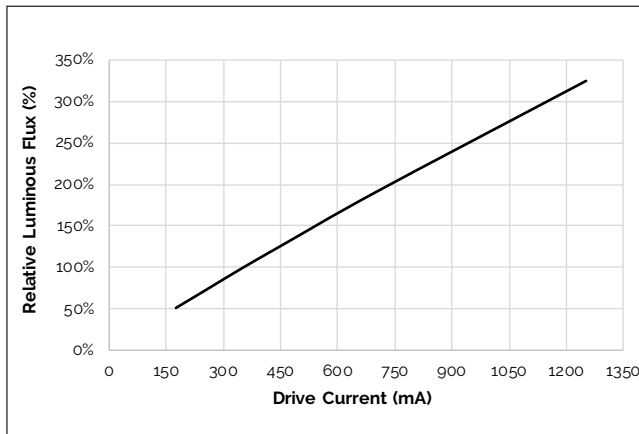
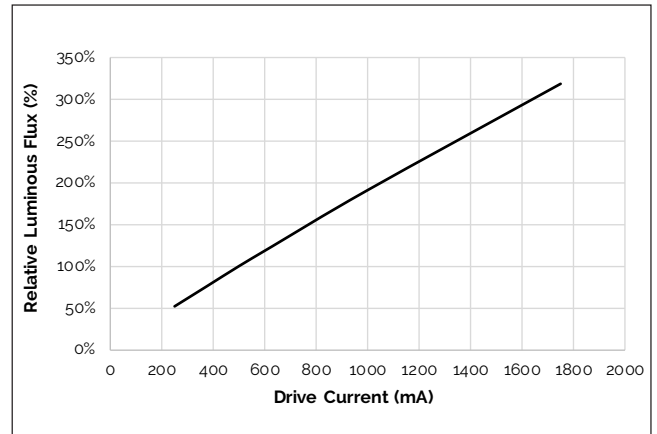

Figure 4: V13C Typical Relative Flux vs. Current



Notes for Figures 1-4:

1. Bridgelux does not recommend driving high power LEDs at low currents. Doing so may produce unpredictable results. Pulse width modulation (PWM) is recommended for dimming effects.
2. Products tested under pulsed condition (10ms pulse width) at nominal test current where T_j (junction temperature) = T_c (case temperature) = 25°C.

Performance Curves

Figure 5: Typical DC Flux vs. Case Temperature

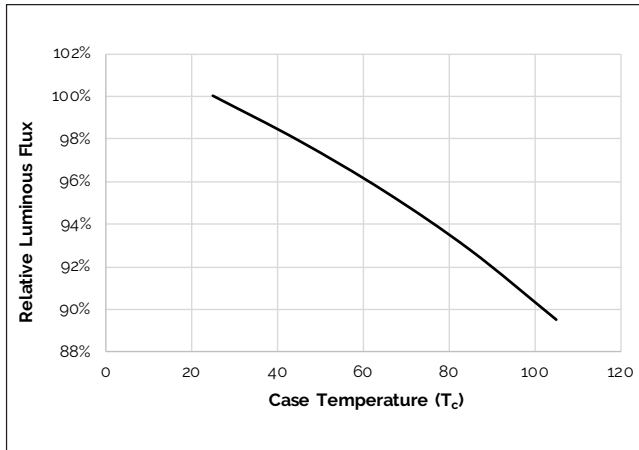

Figure 6: Typical DC ccy Shift vs. Case Temperature

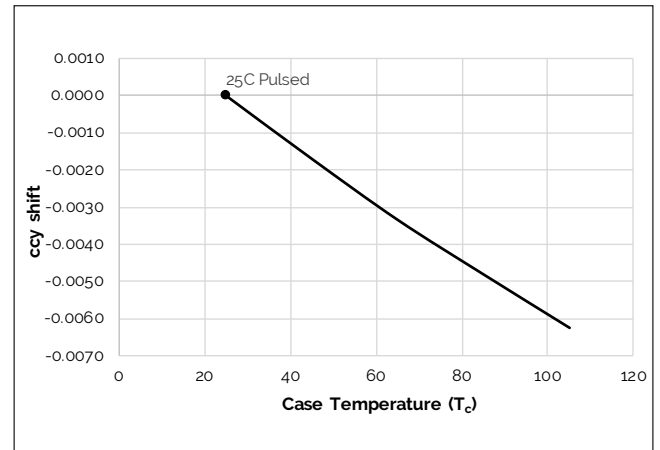
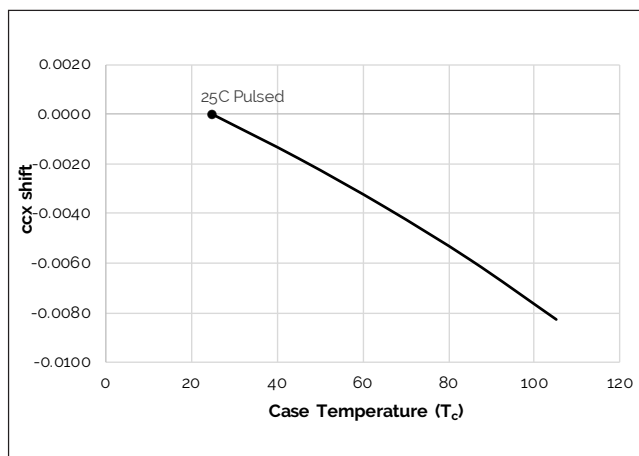

Figure 7: Typical DC ccx Shift vs. Case Temperature



Notes for Figures 5-7:

1. Characteristics shown for warm white based on 3000K and 80 CRI.
2. Characteristics shown for neutral white based on 4000K and 80 CRI.
3. Characteristics shown for cool white based on 5000K and 70 CRI.
4. Characteristics shown for warm white includes Decor Series Class A
5. For other color SKUs, the shift in color will vary. Please contact your Bridgelux Sales Representative for more information.

Typical Radiation Pattern

Figure 8: Typical Spatial Radiation Pattern

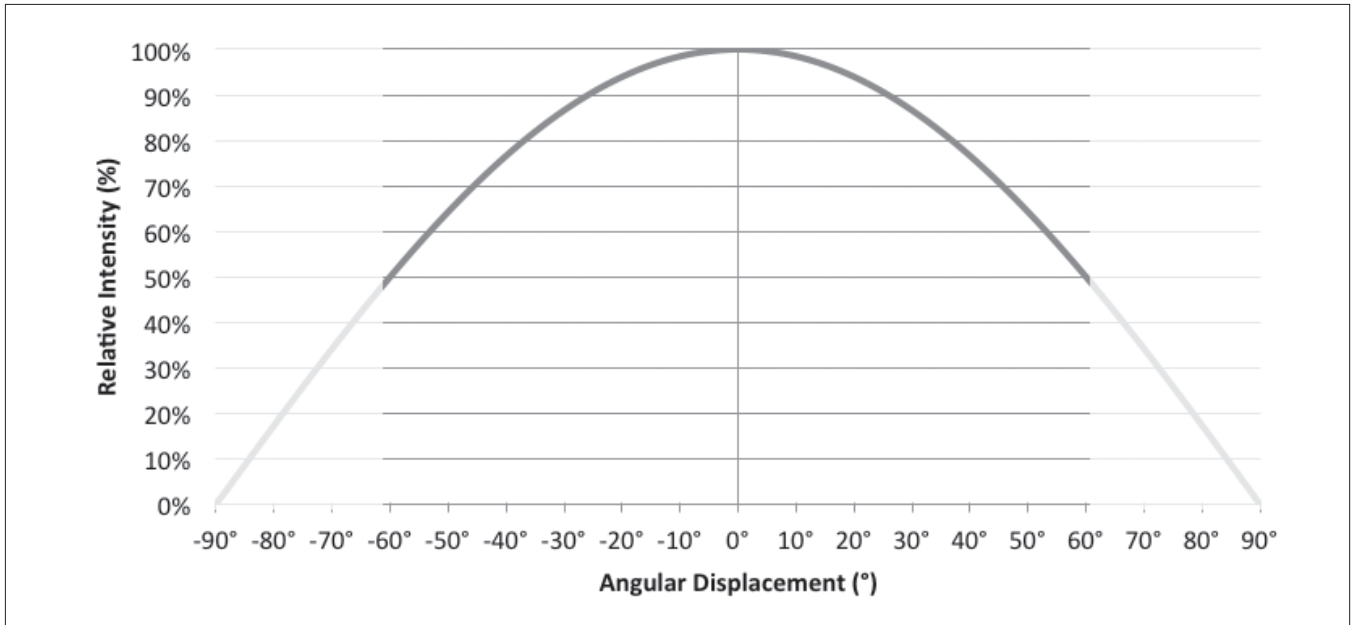

Note for Figure 8:

1. Typical viewing angle is 120°.
2. The viewing angle is defined as the off axis angle from the centerline where intensity is ½ of the peak value.

Figure 9: Typical Polar Radiation Pattern

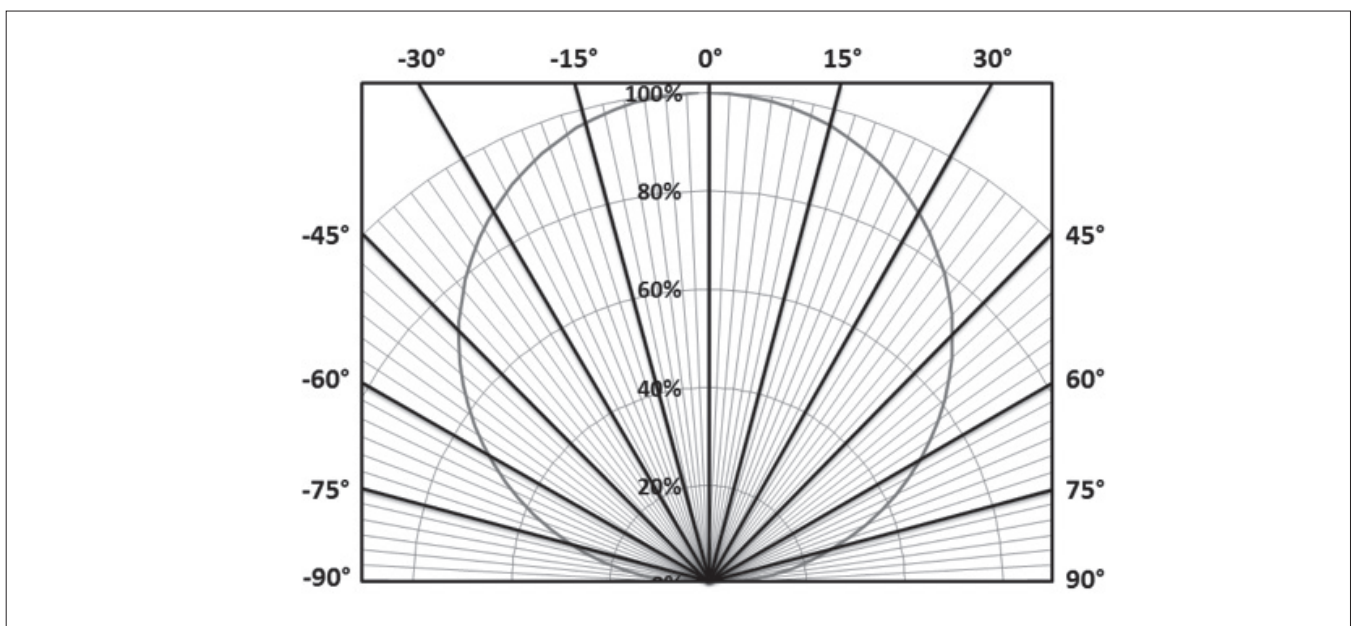

Typical Color Spectrum

Figure 10: Typical Color Spectrum

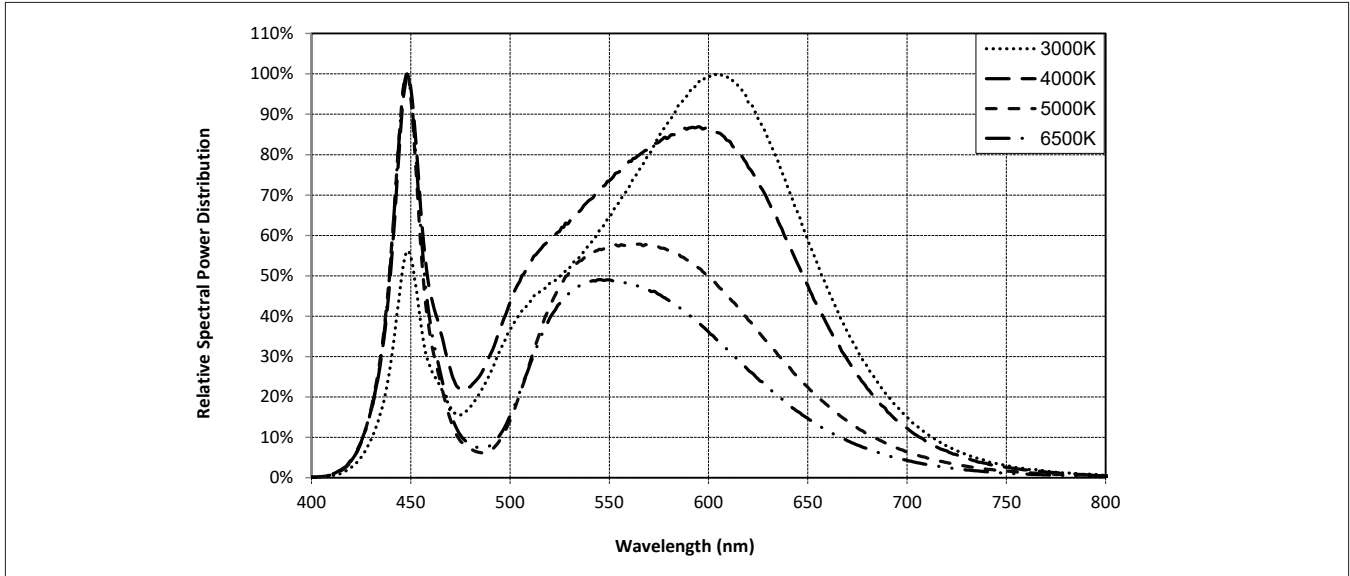

Note for Figure 10:

1. Color spectra measured at nominal current for $T_j = T_c = 25^\circ\text{C}$.
2. Color spectra shown is 3000K and 80 CRI.
3. Color spectra shown is 4000K and 80 CRI.
4. Color spectra shown is 5000K and 70 CRI.
4. Color spectra shown is 6500K and 70 CRI.

Mechanical Dimensions

Figure 11: Drawing for V13 LED Array

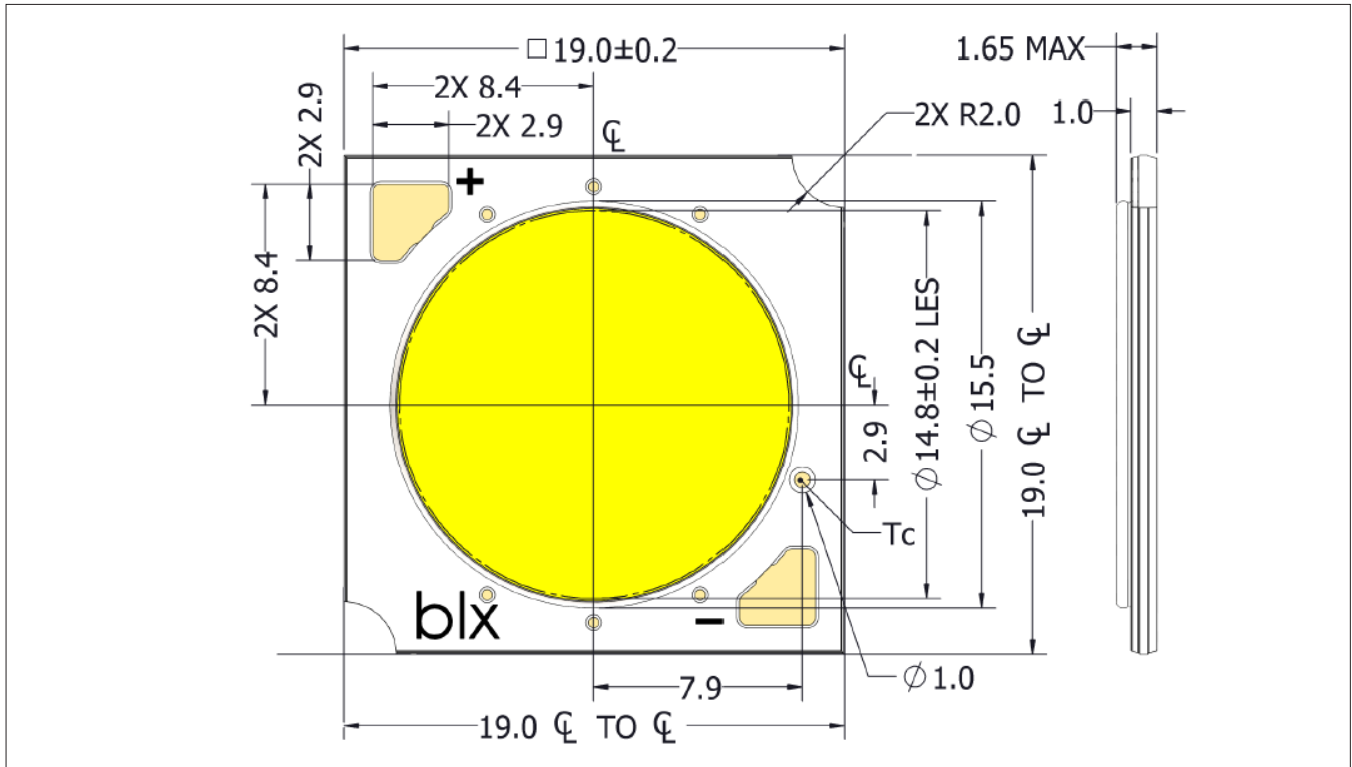

Notes for Figure 11:

1. Drawings are not to scale.
2. Drawing dimensions are in millimeters.
3. Unless otherwise specified, tolerances are ± 0.1 mm.
4. Solder pad labeled "+" denotes positive contact.
5. Refer to Application Notes AN101 for product handling, mounting and heat sink recommendations.
6. The optical center of the LED Array is nominally defined by the mechanical center of the array to a tolerance of ± 0.2 mm.
7. Bridgelux maintains a flatness of 0.10 mm across the mounting surface of the array.

Color Binning Information

Figure 12: Warm and Neutral White Test Bins in xy Color Space

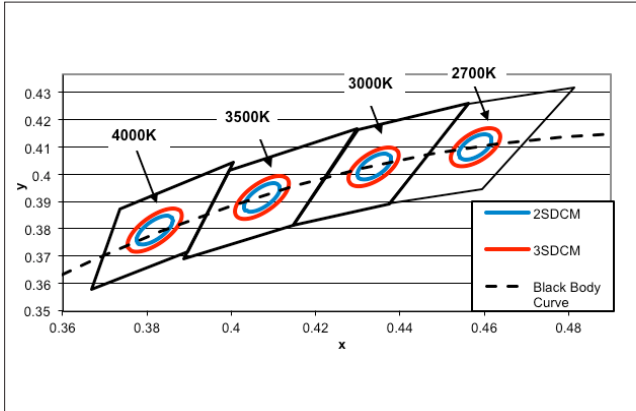

Note: Pulsed Test Conditions, $T_c = 25^\circ\text{C}$

Figure 13: Cool White Test Bins in xy Color Space

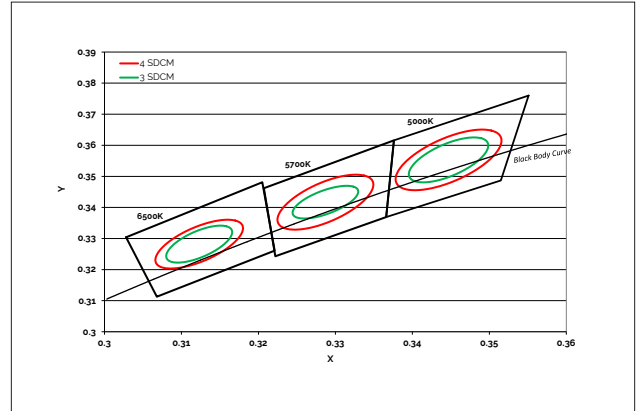

Table 7: Warm and Neutral White xy Bin Coordinates and Associated Typical CCT

Bin Code	2700K	3000K	3500K	4000K
ANSI Bin (for reference only)	(2580K - 2870K)	(2870K - 3220K)	(3220K - 3710K)	(3710K - 4260K)
83 (3 SDCM)	(2651K - 2794K)	(2968K - 3136K)	(3369K - 3586K)	(3851K - 4130K)
82 (2 SDCM)	(2674K - 2769K)	(2995K - 3107K)	(3404K - 3548K)	(3895K - 4081K)
Center Point (x,y)	(0.4578, 0.4101)	(0.4338, 0.403)	(0.4073, 0.3917)	(0.3818, 0.3797)

Table 8: Cool White xy Bin Coordinates and Associated Typical CCT (product is hot targeted to $T_c = 85^\circ\text{C}$)

Bin Code	5000K	5700K	6500K
ANSI Bin (for reference only)	(4745K - 5311K)	(5312K - 6022K)	(6022K - 7042K)
84 (4 SDCM)	(4801K - 5282K)	(5829K - 5481K)	(6270K - 6765K)
83 (3 SDCM)	(4835K - 5215K)	(5490K - 5820K)	(6250K - 6745K)
Center Point (x,y)	(0.3447, 0.3553)	(0.3287, 0.3417)	(0.3123, 0.3282)

Packaging and Labeling

Figure 14: Drawing for V13 Packaging Tubes



Notes for Figure 14:

1. Each tube holds 25 V13 COB arrays.
2. One tube is sealed in an anti-static bag. Four bags are placed in a shipping box. Depending on quantities ordered, a bigger shipping box, containing four boxes may be used to ship products.
3. Each bag and box is to be labeled as shown above.
4. Dimensions for each tube are 21.3 (W) x 9.5(H) x 505 (L). Dimensions for the anti-static bag are 75 (W) x 615 (L) x 3.1 (T) mm. Dimensions for the shipping box are 58.7 x 13.3 x 7.9 cm.

Packaging and Labeling

Figure 15: Gen. 8 Product Labeling

Bridgelux COB arrays have laser markings on the back side of the substrate to help with product identification. In addition to the product identification markings, Bridgelux COB arrays also contain markings for internal Bridgelux manufacturing use only. The image below shows which markings are for customer use and which ones are for Bridgelux internal use only. The Bridgelux internal manufacturing markings are subject to change without notice, however these will not impact the form, function or performance of the COB array.

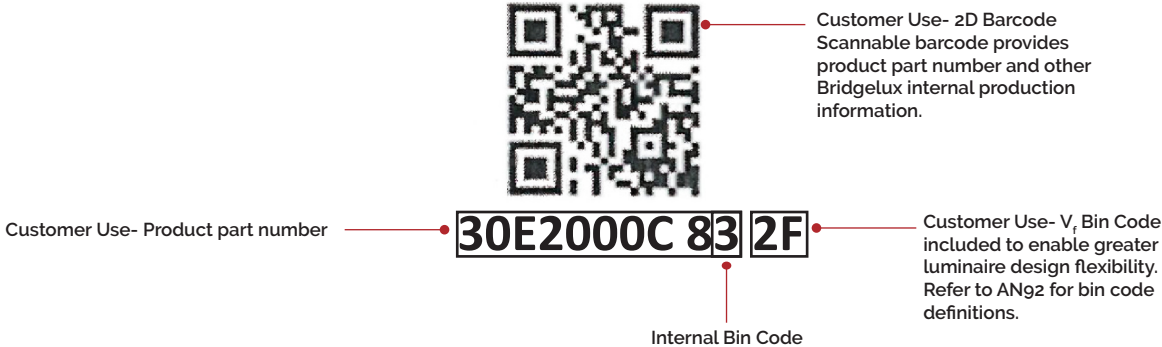

Design Resources

Application Notes

Bridgelux has developed a comprehensive set of application notes and design resources to assist customers in successfully designing with the V Series product family of LED array products. For all available application notes visit www.bridgelux.com.

Optical Source Models

Optical source models and ray set files are available for all Bridgelux products. For a list of available formats, visit www.bridgelux.com.

3D CAD Models

Three dimensional CAD models depicting the product outline of all Bridgelux V Series LED arrays are available in both IGS and STEP formats. Please contact your Bridgelux sales representative for assistance.

LM80

LM80 testing has been completed and the LM80 report is now available. Please contact your Bridgelux sales representative for LM-80 report.

Precautions

CAUTION: CHEMICAL EXPOSURE HAZARD

Exposure to some chemicals commonly used in luminaire manufacturing and assembly can cause damage to the LED array. Please consult Bridgelux Application Note AN101 for additional information.

CAUTION: RISK OF BURN

Do not touch the V Series LED array during operation. Allow the array to cool for a sufficient period of time before handling. The V Series LED array may reach elevated temperatures such that could burn skin when touched.

CAUTION

CONTACT WITH LIGHT EMITTING SURFACE (LES)

Avoid any contact with the LES. Do not touch the LES of the LED array or apply stress to the LES (yellow phosphor resin area). Contact may cause damage to the LED array.

Optics and reflectors must not be mounted in contact with the LES (yellow phosphor resin area).

Disclaimers

MINOR PRODUCT CHANGE POLICY

The rigorous qualification testing on products offered by Bridgelux provides performance assurance. Slight cosmetic changes that do not affect form, fit, or function may occur as Bridgelux continues product optimization.

STANDARD TEST CONDITIONS

Unless otherwise stated, array testing is performed at the nominal drive current.

About Bridgelux: Bridging Light and Life™

At Bridgelux, we help companies, industries and people experience the power and possibility of light. Since 2002, we've designed LED solutions that are high performing, energy efficient, cost effective and easy to integrate. Our focus is on light's impact on human behavior, delivering products that create better environments, experiences and returns—both experiential and financial. And our patented technology drives new platforms for commercial and industrial luminaires.

For more information about the company, please visit
bridgelux.com
twitter.com/Bridgelux
facebook.com/Bridgelux
youtube.com/user/Bridgelux
linkedin.com/company/bridgelux-inc-_2
WeChat ID: BridgeluxInChina



46430 Fremont Boulevard
Fremont, CA 94538 U.S.A.
Tel (925) 583-8400
www.bridgelux.com

© 2020 Bridgelux, Inc. All rights reserved. Product specifications are subject to change without notice. Bridgelux, the Bridgelux stylized logo design and Vero are registered trademarks. V Series and Decor Series are trademarks of Bridgelux, Inc. All other trademarks are the property of their respective owners.

Bridgelux Gen 8 V13 Array Series Product Data Sheet DS413 Rev. A (06/2020)