

RTHC SERIES

High Attenuation Three-Phase Filter with Many Current Variations (Cube Type)



FEATURES

- 6 to 300A wide range lineup.
- Cube shape with L2 high attenuation .
- Small base and short connection width.
- Self-tightening screws and an open/close type cover make wiring work easier.
- Terminal block cover included for safety.

SAFETY STANDARDS

UL1283 (Up to 150A)
EN60939-1/-2 (ENEC14)

PRODUCT IDENTIFICATION

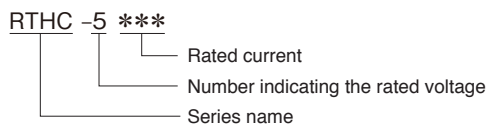

CONFORMITY TO RoHS Directive

CIRCUIT DIAGRAM

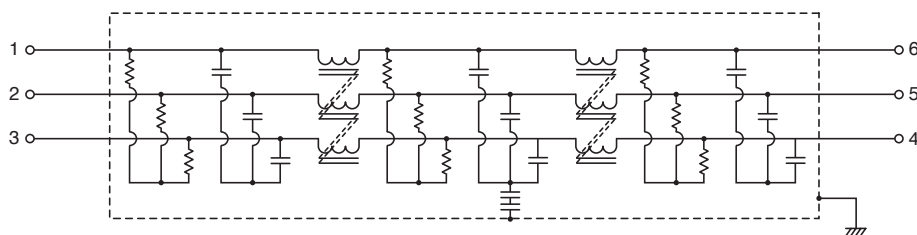

ELECTRICAL CHARACTERISTICS

Part No.	Rated voltage (AC/DC)	Rated current (AC/DC)	Withstand voltage	Insulation resistance	Leakage current	Operating temperature range	With derating over	DC resistance (mΩ)	Attenuation frequency range (MHz)		Weight (kg)
									Common mode	Differential mode	
									at 25dB	at 25dB	
RTHC-5006	500V	6A	AC.2500V 60s [Between line to ground]	100MΩ min. [DC.500V/ 1min]	2.5mA max. [250V/60Hz] 5mA max. [500V/60Hz]	-25 to +85°C	50°C	290 max.	0.1 to 10	0.2 to 30	0.80
RTHC-5010		10A						120 max.	0.1 to 10	0.2 to 30	0.82
RTHC-5020		20A						50 max.	0.1 to 10	0.2 to 30	1.20
RTHC-5030		30A						26 max.	0.2 to 10	0.2 to 30	1.20
RTHC-5040		40A						20 max.	0.2 to 10	0.2 to 30	2.26
RTHC-5050		50A						14 max.	0.2 to 10	0.2 to 30	2.26
RTHC-5060		60A						10 max.	0.2 to 10	0.2 to 30	2.26
RTHC-5080		80A						10 max.	0.1 to 10	0.2 to 30	7.40
RTHC-5100		100A						8 max.	0.1 to 10	0.2 to 30	7.80
RTHC-5150		150A						6 max.	0.1 to 10	0.2 to 30	12.00
RTHC-5200		200A						4 max.	0.3 to 10	0.2 to 30	16.30
RTHC-5250		250A						3 max.	0.3 to 10	0.2 to 30	15.60
RTHC-5300		300A						2 max.	0.5 to 6	0.2 to 30	14.80

DERATING GRAPH

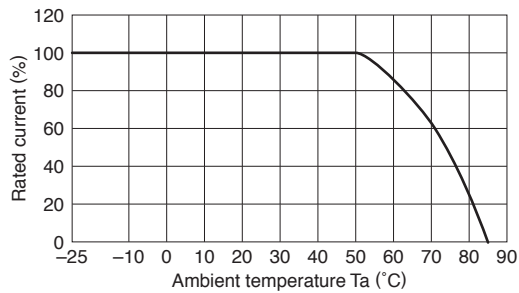

MECHANICAL

RTHC-5006/5010/5020/5030/5040/5050/5060/5080/5100/5150

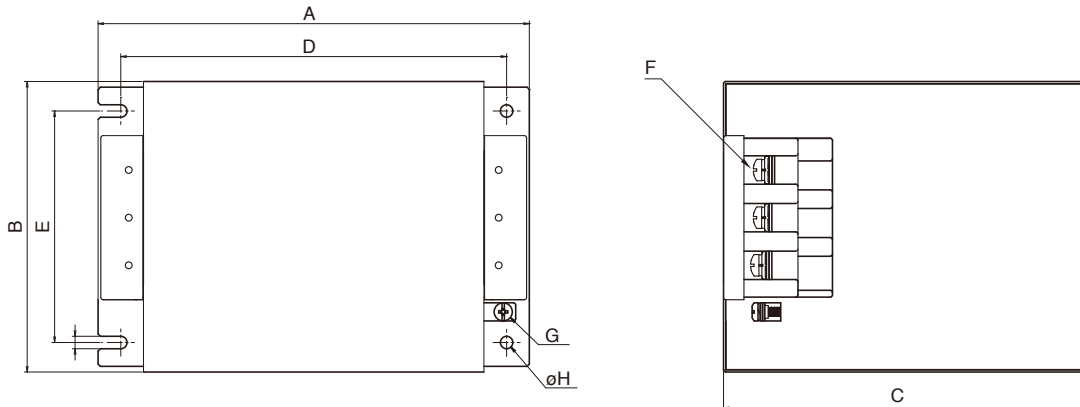

RTHC-5200/5250/2300

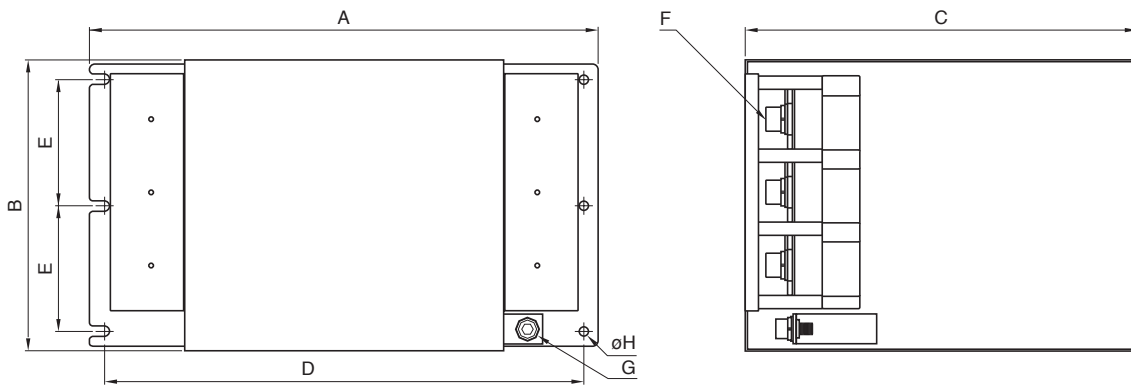

Dimensions in mm

Part No.	A	B	C	D	E	F	G	φH	Recommended clamping torque
RTHC-5006	145	95	120	130	78	M4	M4	4.5	M4 : 1.27N · m M5 : 2.5N · m M6 : 4.8N · m M8 : 7.64N · m M10 : 11.8N · m
RTHC-5010									
RTHC-5020	160	105	135	145	85	M4	M4		
RTHC-5030									
RTHC-5040	190	128	160	170	102	M5	M4	5.5	
RTHC-5050									
RTHC-5060									
RTHC-5080	240	161	210	220	135	M8	M6	6.5	
RTHC-5100									
RTHC-5150	255	190	232	235	164	M8	M6	6.5	
RTHC-5200									
RTHC-5250	340	195	262	320	84.5	M10	M8	6.5	
RTHC-5300									

■ ATTENUATION vs. FREQUENCY CHARACTERISTICS

RTHC-5006

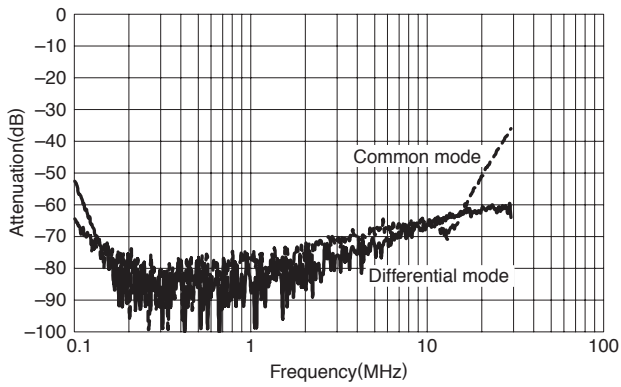

RTHC-5010

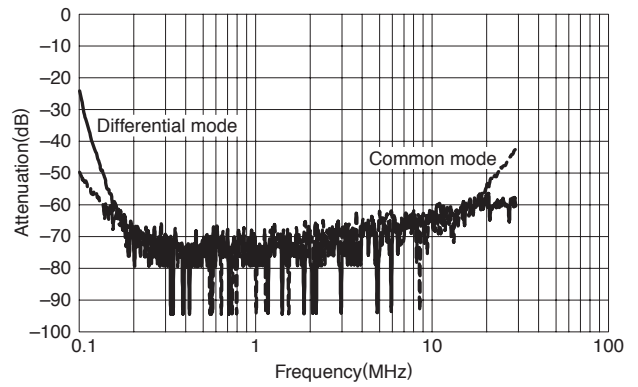

RTHC-5020

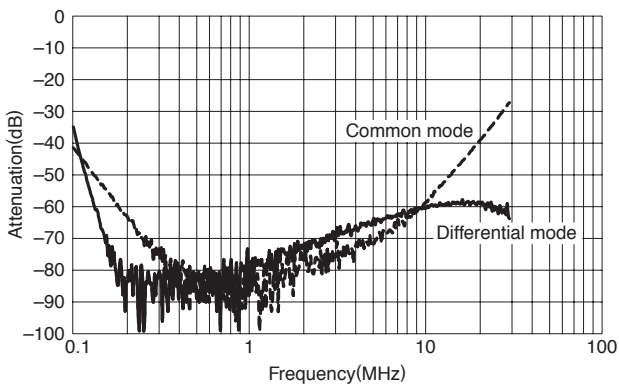

RTHC-5030

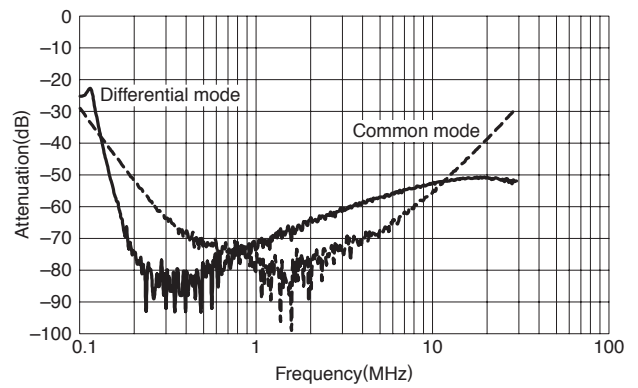

RTHC-5040

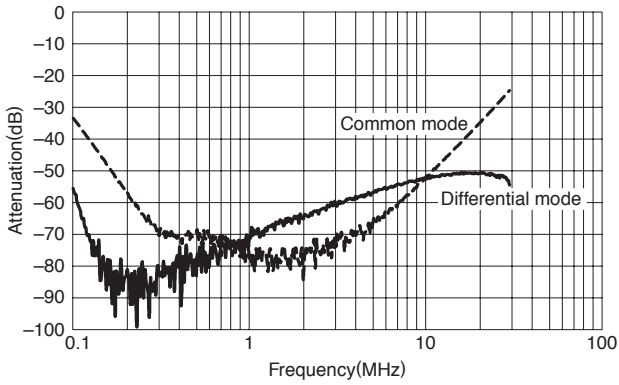

RTHC-5050

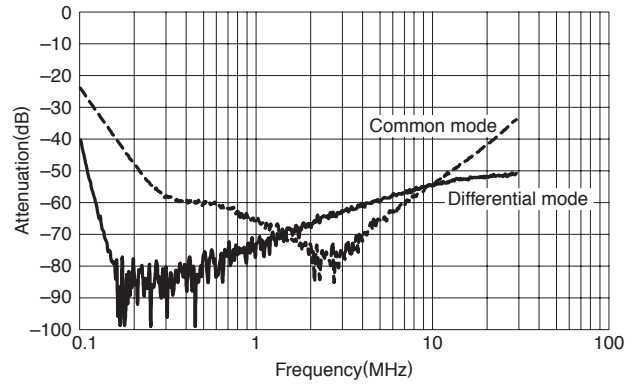

RTHC-5060

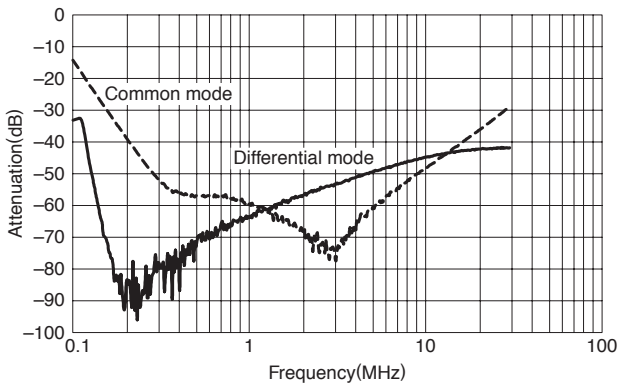

RTHC-5080

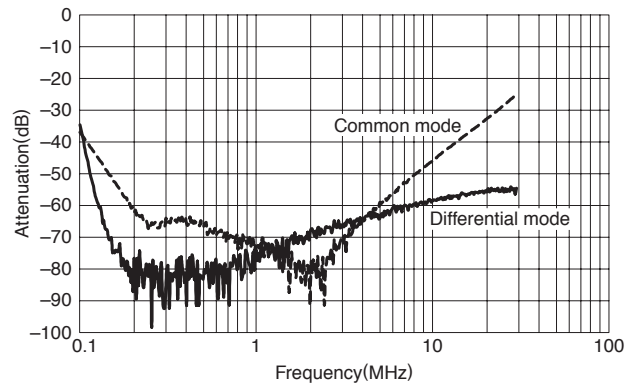

RTHC-5100

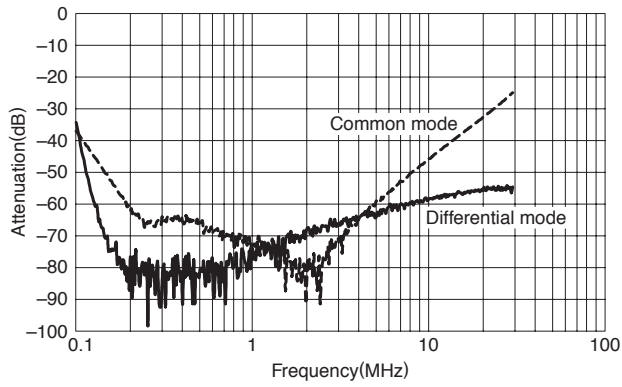

RTHC-5150

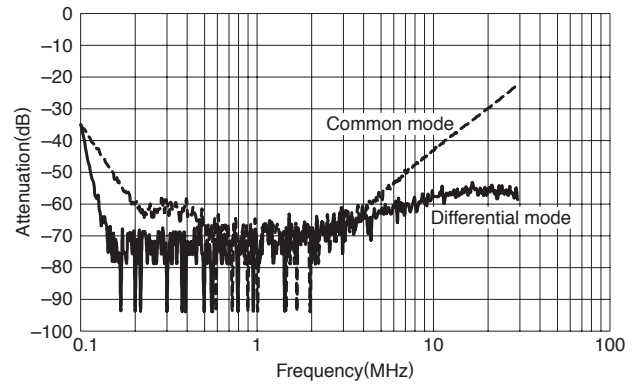

RTHC-5200

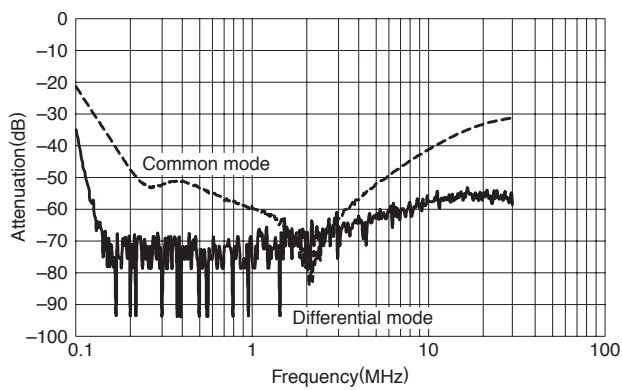

RTHC-5250

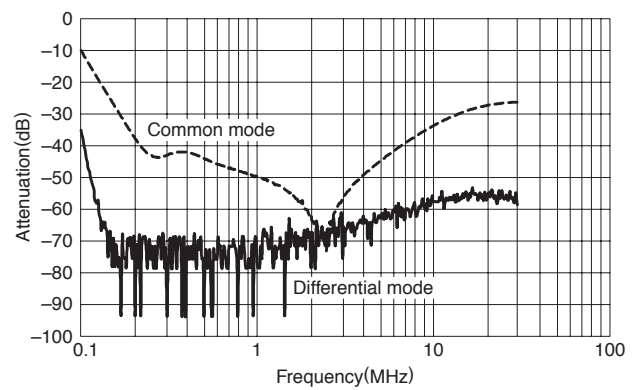

RTHC-5300

