

PAGE 1/2	ISSUE 18-11-16D	SERIES ATTENUATEUR	PART NUMBER R411706124
----------	-----------------	-----------------------	------------------------

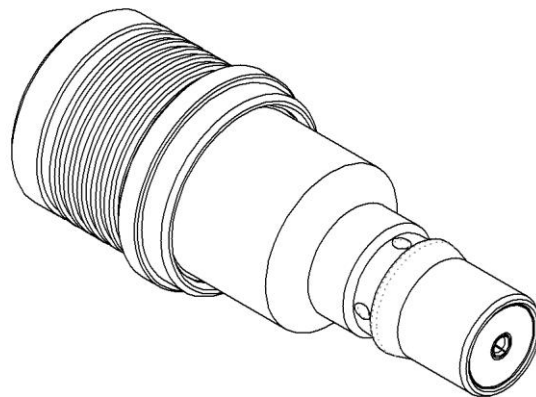

All dimensions are in mm.

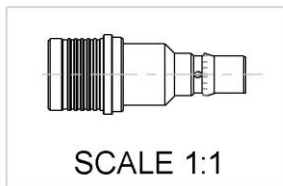
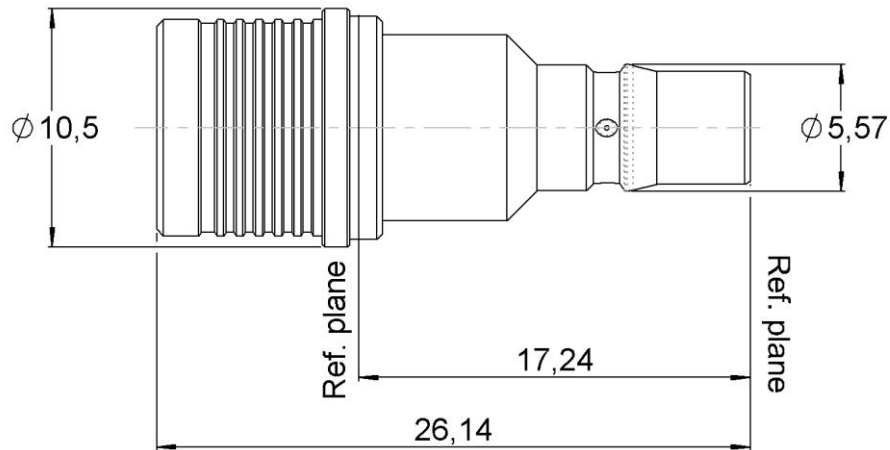
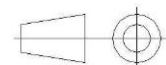

COMPONENTS	MATERIALS	PLATING (μm)
Body	BRASS	BBR
Male center contact	BRASS	GOLD OVER COPPER
Female center contact	BERYLLIUM COPPER	GOLD OVER COPPER
Outer contact	BRONZE	BBR
Insulator	PTFE	
Gasket	-	
Substrate	ALUMINA	
Resistor	THICK FILM	
Others parts	-	

PAGE 2/2	ISSUE 18-11-16D	SERIES ATTENUATEUR	PART NUMBER R411706124
----------	-----------------	-----------------------	------------------------

ELECTRICAL CHARACTERISTICS

Frequency (GHz)	DC - 2	2 - 6
V.S.W.R (≤)	1.20	1.30
Deviation(±dB)	0.30	0.50

Operating Frequency Range	DC - 6	GHz
Impedance	50	Ω
Nominal Attenuation	6	dB
Peak power at 25°C (1μs, 1%)	100	W
Average power at 25°C	1	W (Free Air Cooled)
		W (Conduction Cooled)

MECHANICAL CHARACTERISTICS

Connectors	QMA	Male Female
Weight	6,2500 g	

ENVIRONMENTAL CHARACTERISTICS

Operating temperature range	-40/+85 °C
Storage temperature range	-40/+85 °C

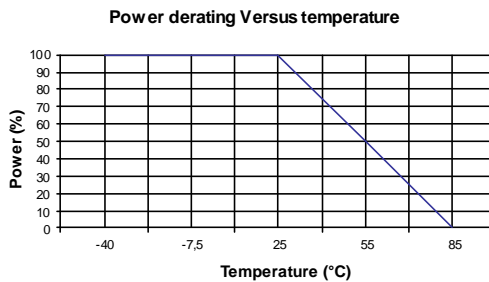

SPECIFICATION

OTHER CHARACTERISTICS