



The Future of Analog IC Technology®

MP28266

21V, 3A, 500kHz, Synchronous Step-Down Converter

DESCRIPTION

The MP28266 is a synchronous, rectified, step-down, switch-mode converter with built in internal power MOSFETs. It offers a very compact solution to achieve a 3A continuous output current over a wide input supply range, with excellent load and line regulation. The MP28266 has synchronous mode operation for higher efficiency over the output-current-load range.

Current-mode operation provides a fast transient response and eases loop stabilization. Full protection features include over-current protection and thermal shutdown.

The MP28266 requires a minimal number of readily-available standard external components, and is available in a space-saving 3mm×4mm 14-pin QFN package.

FEATURES

- Wide 6V-to-21V Operating Input Range
- 0.6V Internal Reference with 2% Accuracy
- 3A Output Current
- Low- $R_{ds(ON)}$ Internal Power MOSFETs
- Fixed 500kHz Switching Frequency
- Frequency SYNC from a 300kHz-to-2MHz External Clock
- External Soft-Start
- AAM Power-Save Mode
- OCP and Thermal Shutdown
- Available in a 3mm×4mm QFN14 Package.

APPLICATIONS

- DSL Modems
- Cable Modems
- Set Top Boxes

All MPS parts are lead-free and adhere to the RoHS directive. For MPS green status, please visit MPS website under Quality Assurance. "MPS" and "The Future of Analog IC Technology" are Registered Trademarks of Monolithic Power Systems, Inc.

TYPICAL APPLICATION

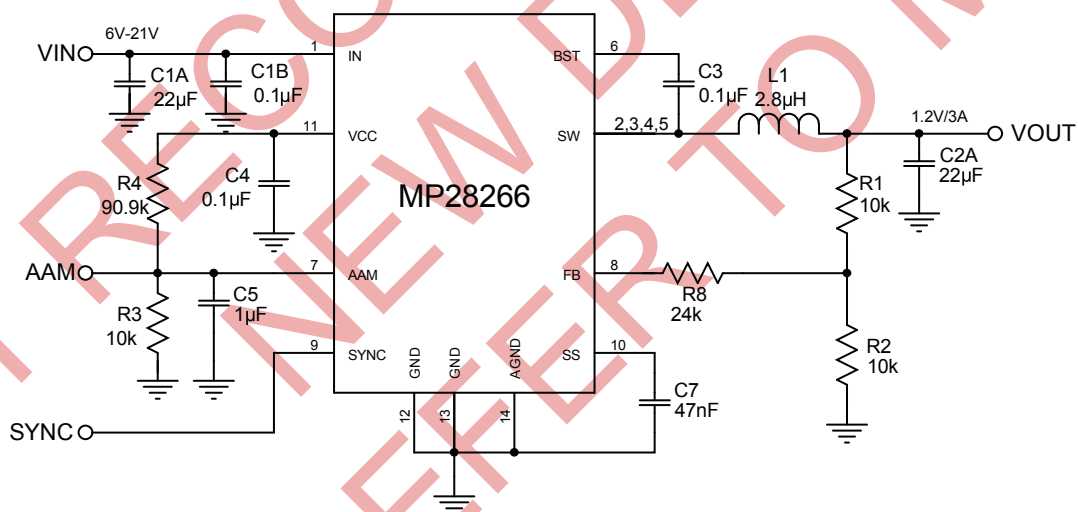

ORDERING INFORMATION

Part Number*	Package	Top Marking	Free Air Temperature (T _A)
MP28266DL	QFN14 (3x4mm)	MP28266DL	-40°C to +85°C

* For Tape & Reel, add suffix -Z (eg. MP28266DL-Z);
 For RoHS, compliant packaging, add suffix -LF (eg. MP28266DL-LF-Z).

PACKAGE REFERENCE

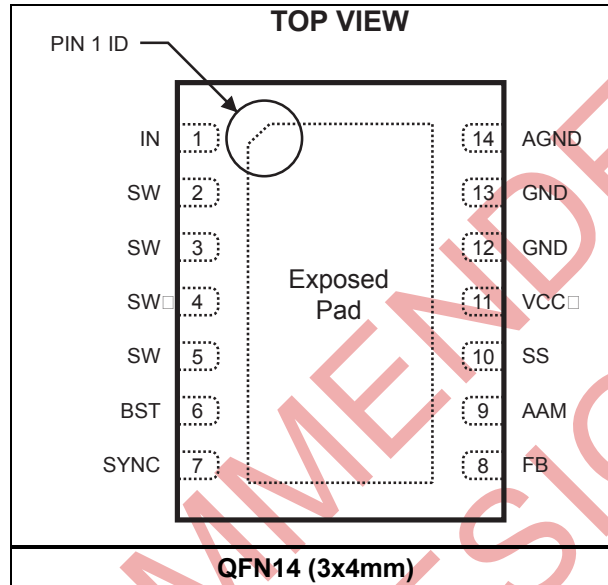

ABSOLUTE MAXIMUM RATINGS ⁽¹⁾

V _{IN}	-0.3V to 24V
V _{SW}	-0.3V to 24V
V _{BST}	V _{SW} + 6V
All Other Pins	-0.3V to 6V
Junction Temperature	150°C
Lead Temperature	260°C
Junction Temperature	150°C
Continuous Power Dissipation (T _A = +25°C) ⁽²⁾	2.6W

Recommended Operating Conditions ⁽³⁾

Supply Voltage V _{IN}	6V to 21V
Output Voltage V _{OUT}	0.6V to 18V
Maximum Junction Temp. (T _J)	+125°C

Thermal Resistance ⁽⁴⁾	θ_{JA}	θ_{JC}
QFN14 (3x4mm)	48	11... °C/W

Notes:

- Exceeding these ratings may damage the device.
- The maximum allowable power dissipation is a function of the maximum junction temperature T_J (MAX), the junction-to-ambient thermal resistance θ_{JA} , and the ambient temperature T_A. The maximum allowable continuous power dissipation at any ambient temperature is calculated by P_D (MAX) = (T_J (MAX) - T_A) / θ_{JA} . Exceeding the maximum allowable power dissipation will cause excessive die temperature, and the regulator will go into thermal shutdown. Internal thermal shutdown circuitry protects the device from permanent damage.
- The device is not guaranteed to function outside of its operating conditions.
- Measured on JESD51-7, 4-layer PCB.

ELECTRICAL CHARACTERISTICS
V_{IN} = 12V, T_A = 25°C, unless otherwise noted.

Parameters	Symbol	Condition	Min	Typ	Max	Units
Supply Current (Quiescent)	I _q	V _{IN} = 12V, V _{FB} = 1V, V _{AAM} =5V	0.55	0.7	0.85	mA
		V _{IN} = 12V, V _{FB} = 1V, V _{AAM} =0.5V	0.45	0.6	0.75	
HS Switch On Resistance	HS _{RDS-ON}			120		mΩ
LS Switch On Resistance	LS _{RDS-ON}			20		mΩ
Switch Leakage	SW _{LKG}	V _{SW} = 0V or 12V, V _{FB} = 0.7V, V _{AAM} =0.5V		0.1	1	μA
Current Limit ⁽⁵⁾	I _{LIMIT}	D=40%	4.2	5.5		A
Oscillator Frequency	f _{SW}	V _{FB} =550mV	425	500	595	kHz
Minimum On Time ⁽⁵⁾	t _{ON-MIN}			80		ns
Maximum Duty Cycle	D _{MAX}	V _{FB} = 550mV	85	90		%
Sync Frequency Range	f _{SYNC}		0.3		2	MHz
Feedback Voltage	V _{FB}	T _A = 25°C	591	603	615	mV
		-40°C<T _A <85°C ⁽⁶⁾	588	603	618	
Feedback Current	I _{FB}	V _{FB} = 650mV		10	50	nA
AAM-High Threshold	V _{AAM_HIGH}		2.9			V
AAM-Low Threshold	V _{AAM_LOW}				2.2	V
AAM Input Current	I _{AAM}	V _{AAM} =0V		0		μA
		V _{AAM} =5V		3.3		μA
SYNC Input HIGH Level	V _{HI}		1.8			V
SYNC Input LOW Level	V _{LO}				0.4	V
SYNC Input Current	I _{SYNC}	V _{SYNC} =6V		6		μA
Soft-Start current	I _{SS}	V _{SS} =0		10		μA
V _{IN} Under-Voltage Lockout Threshold—Rising	INUV _{Vth_rising}		5.2	5.5	5.8	V
V _{IN} Under-Voltage Lockout Threshold—Falling	INUV _{Vth_falling}		4.1	4.4	4.7	V
VCC Regulator	V _{CC}			5		V
VCC Load Regulation		I _{CC} =5mA		5		%
Thermal Shutdown ⁽⁵⁾	T _{SD}			150		°C

Notes:

- 5) Guaranteed by design.
6) Not tested in production and guaranteed by over-temperature correlation.

TYPICAL PERFORMANCE CHARACTERISTICS

Performance curves are tested on the evaluation board of the Design Example section.
 $V_{IN} = 12V$, $V_{OUT} = 1.2V$, $V_{AAM} = 0.5V$, $L = 2.8\mu H$, $T_A = +25^\circ C$, unless otherwise noted.

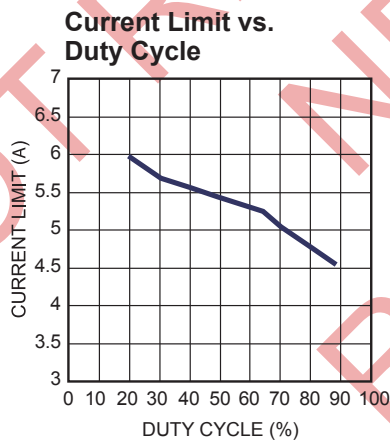
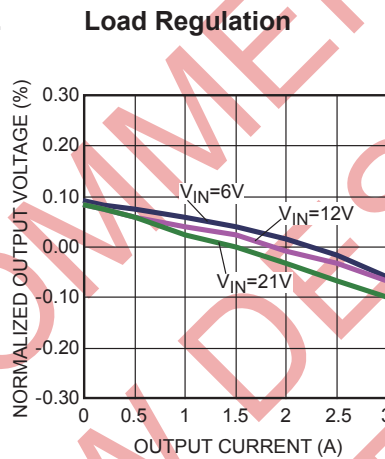
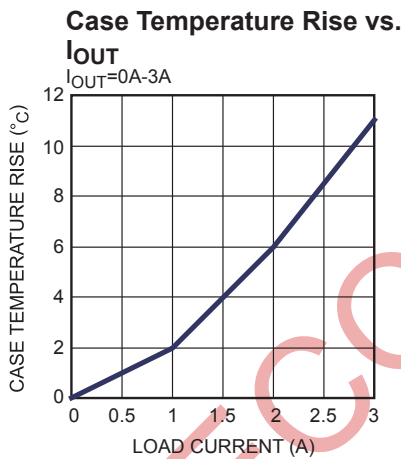
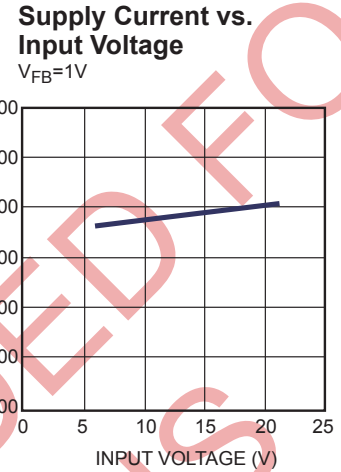
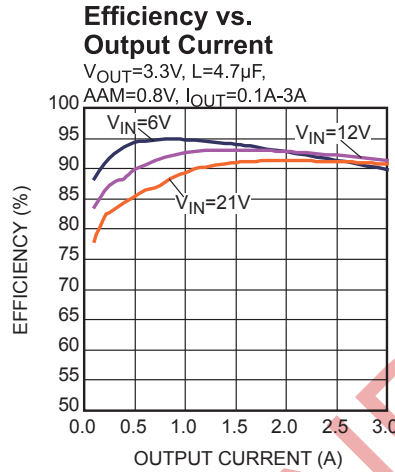
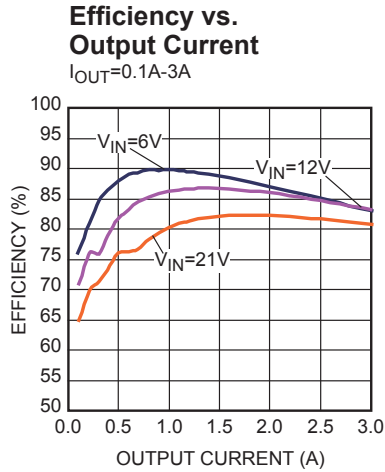

TYPICAL PERFORMANCE CHARACTERISTICS (continued)

Performance curves are tested on the evaluation board of the Design Example section.
 $V_{IN} = 12V$, $V_{OUT} = 1.2V$, $V_{AAM} = 0.5V$, $L = 2.8\mu H$, $T_A = +25^\circ C$, unless otherwise noted.

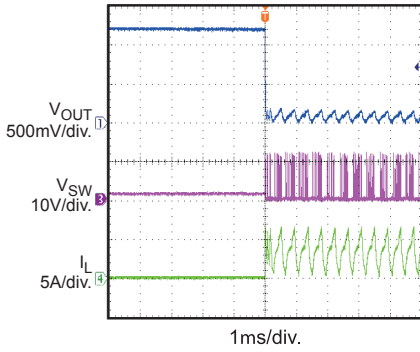
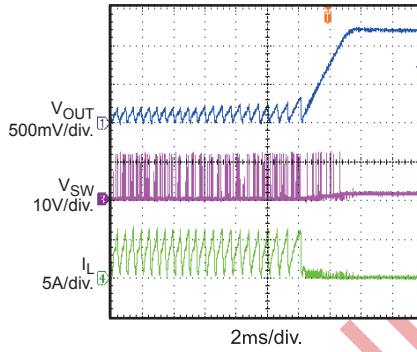
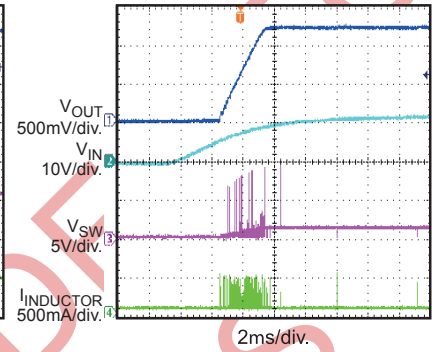
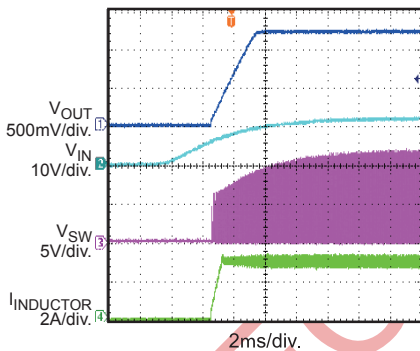
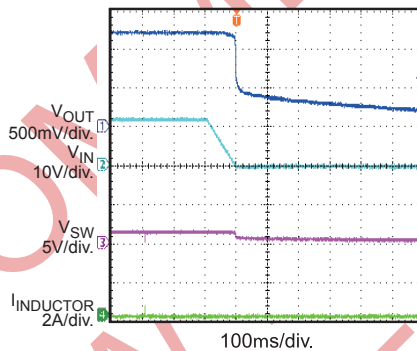
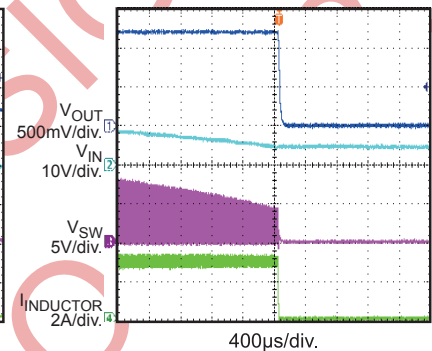
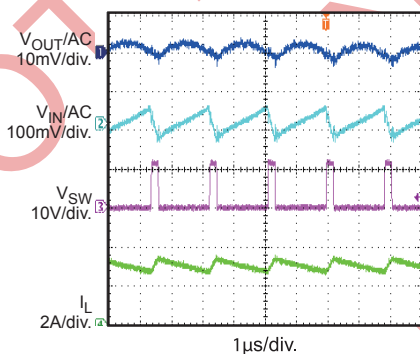
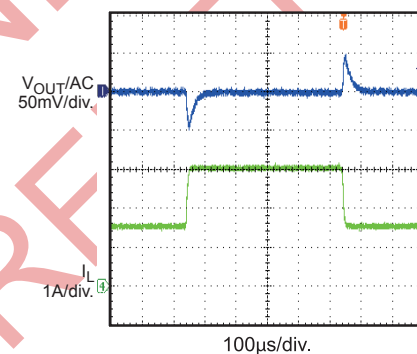
Short Entry
 $I_{OUT} = 0A$

Short Recovery
 $I_{OUT} = 0A$

Startup through Input Voltage
 $I_{OUT} = 0A$

Startup through Input Voltage
 $I_{OUT} = 3A$

Shutdown through Input Voltage
 $I_{OUT} = 0A$

Shutdown through Input Voltage
 $I_{OUT} = 3A$

Input/Output Ripple
 $I_{OUT} = 3A$

Load Transient Response
 $I_{OUT} = 1.5A-3A$

PIN FUNCTIONS

QFN14 Pin #	Name	Description
1	IN	Supply Voltage. The MP28266 operates from a 6V-to-21V input rail. C1 decouples the input rail. Connect using wide PCB traces and multiple vias.
2,3,4,5	SW	Switch Output. Connect using wide PCB traces and multiple vias.
6	BST	Bootstrap. A capacitor connected between SW and BST pins is required to form a floating supply across the high-side switch driver.
7	SYNC	This pin serves as frequency synchronous clock input.
8	FB	Feedback. Connect to the tap of an external resistor divider from the output to GND to set the output voltage. To prevent current-limit runaway during a short circuit fault condition, the frequency fold-back comparator lowers the oscillator frequency when the FB voltage is below 100mV.
9	AAM	Advanced Asynchronous Modulation. Connect to a voltage supply through 2 resistor dividers to force the MP28266 into non-synchronous mode under light loads. Drive AAM pin high (V _{CC}) to force the MP28266 into CCM.
10	SS	Soft Start. Connect an external capacitor to program the soft start time for the switch mode regulator.
11	VCC	Bias Supply. Decouple with 0.1μF-to-0.22μF capacitor. And the capacitance should be no more than 0.22μF.
12,13	GND	System Ground. This reference ground of the regulated output voltage. Requires special considerations during PCB layout.
14	AGND	Signal Ground. AGND is not internally connected to System Ground; connect AGND to system Ground in PCB layout.
	Exposed Pad	No Internal Connection. Connect the exposed pad to GND plane for optimal thermal performance.

BLOCK DIAGRAM

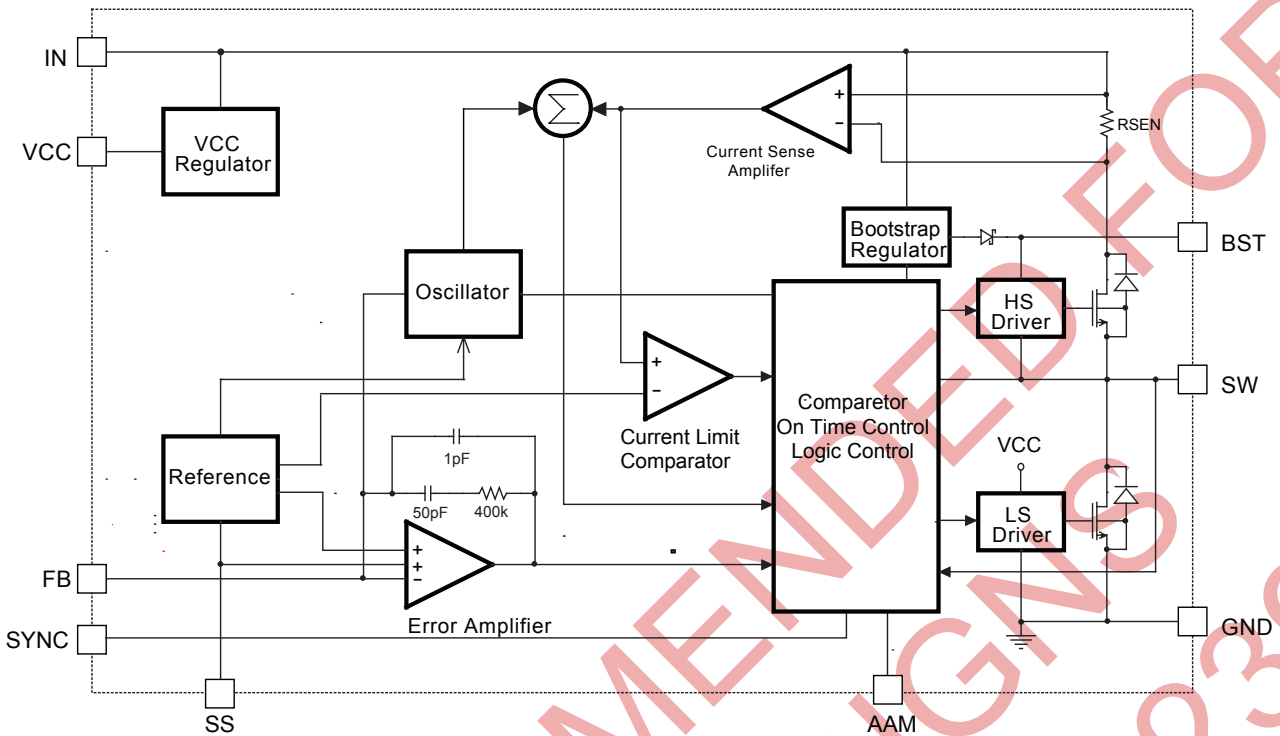

Figure 1: Functional Block Diagram

OPERATION

The MP28266 is a high-frequency, synchronous, rectified, step-down, switch-mode converter with built-in power MOSFETs. It offers a very compact solution to achieve more than 3A continuous output current over a wide input supply range, with excellent load and line regulation.

The MP28266 operates in a fixed-frequency, peak-current-control mode to regulate the output voltage. An internal clock initiates the PWM cycle to turn on the integrated high-side power MOSFET. This MOSFET remains on until its current reaches the value set by the COMP voltage. When the power switch is OFF, it remains off until the next clock cycle starts. If within 90% of one PWM period the power MOSFET current does not reach the COMP-set current value, the power MOSFET will be forced to turn off.

Error Amplifier

The error amplifier compares the FB pin voltage against the internal 0.6V reference (REF) and outputs a current proportional to their difference. This output current charges or discharges the internal compensation network for the COMP voltage, which controls the power MOSFET current. The optimized internal compensation network minimizes the external component counts and simplifies the control loop design.

Internal Regulator

The 5V internal regulator powers most of the internal circuits. This regulator takes the V_{IN} input and operates in the full V_{IN} range. When V_{IN} exceeds 5.0V, the output of the regulator is in full regulation. When V_{IN} is lower than 5.0V, the output decreases and requires a 0.1 μ F ceramic decoupling capacitor.

Frequency Synchronizing

The MP28266 can be synchronized through the SYNC pin to an external clock with a range from 300kHz up to 2MHz. The internal clock rising edge is synchronized to the external clock rising edge.

Under-Voltage Lockout (UVLO)

Under-voltage lockout (UVLO) protects the chip against operating at an insufficient supply voltage.

The MP28266's UVLO comparator monitors the output voltage of the internal regulator, VCC. The UVLO rising threshold is about 5.5V while its falling threshold is a consistent 4.4V.

External Soft-Start

Adjust the soft start time through the capacitor connected from SS to ground. When the soft-start period starts, an internal 10 μ A current source charges the external capacitor. During soft-start, the voltage on the soft-start capacitor connects to the non-inverting input of the error amplifier. The soft-start period lasts until the voltage on the soft-start capacitor exceeds the reference voltage of 0.6V. At this point the reference voltage takes over at the non-inverting error amplifier input. The soft-start time can be calculated as follows:

$$t_{ss}(\text{ms}) = \frac{0.6\text{V} \times C_{ss}(\text{nF})}{10\mu\text{A}}$$

If the output of the MP28266 is pre-biased to a certain voltage during startup, the IC will disable both the high-side and low-side switches until the voltage on the internal soft-start capacitor exceeds the sensed output voltage at the FB pin.

Over-Current Protection

The MP28266 has a hiccup over-current limit for when the inductor current peak value exceeds the set current limit threshold. When the output voltage drops below 70% of the reference while the inductor current exceeds the current limit, the MP28266 enters hiccup mode. This is especially useful to ensure system safety under fault conditions. The latch-off function is disabled during the soft-start duration.

Thermal Shutdown

Thermal shutdown prevents the chip from operating at exceedingly high temperatures. When the silicon die temperature exceeds 150°C, it shuts down the whole chip. When the temperature is below its lower threshold—typically 140°C—the chip is enabled again.

Floating Driver and Bootstrap Charging

An external bootstrap capacitor powers the floating power MOSFET driver. This floating driver has its own UVLO protection with a rising

threshold of 2.2V and a hysteresis of 150mV. V_{IN} internally regulates the bootstrap capacitor voltage through D1, M1, C4, L1 and C2 (Figure 2). If $(V_{IN}-V_{SW})$ exceeds 5V, U1 regulates M1 to maintain a 5V BST voltage across C4.

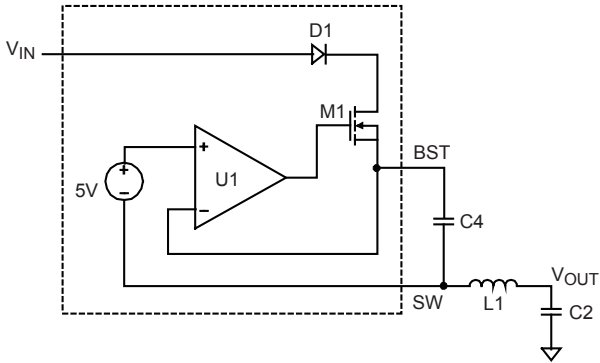

Figure 2: Internal Bootstrap Charging Circuit

NOT RECOMMENDED FOR NEW DESIGNS REFER TO MP2393

APPLICATION INFORMATION

COMPONENT SELECTION

Setting the Output Voltage

The external resistor divider sets the output voltage (see the Typical Application on page 1). The feedback resistor R1—with the internal compensation capacitor—also sets the feedback loop bandwidth (see the Typical Application on page 1). Choose R1 equal to 10kΩ. R2 is then:

$$R2 = \frac{R1}{\frac{V_{OUT}}{0.6V} - 1}$$

The T-type network is highly recommended when V_{OUT} is low.

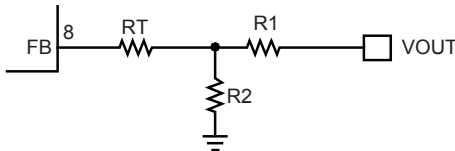

Figure 3: T-Type Network

Table 1 lists the recommended T-type resistors value for common output voltages.

Table 1: Resistor Selection for Common Output Voltages

V_{OUT} (V)	R1 (kΩ)	R2 (kΩ)	Rt (kΩ)
1.05	7.5(1%)	10(1%)	24.9(1%)
1.2	10(1%)	10(1%)	24.9(1%)
1.8	10(1%)	4.99(1%)	24.9(1%)
2.5	10(1%)	3.16(1%)	24.9(1%)
3.3	10(1%)	2.20(1%)	24.9(1%)
5	10(1%)	1.36(1%)	24.9(1%)

Selecting the Inductor

For most applications, use a 1μH-to-10μH inductor with a DC current rating of at least 25% percent higher than the maximum load current. For highest efficiency, select an inductor with a DC resistance less than 15mΩ. For most designs, derive the inductance value from the following equation:

$$L_1 = \frac{V_{OUT} \times (V_{IN} - V_{OUT})}{V_{IN} \times \Delta I_L \times f_{OSC}}$$

Where ΔI_L is the inductor ripple current.

Choose inductor current to be approximately 30% of the maximum load current. The maximum inductor peak current is:

$$I_{L(MAX)} = I_{LOAD} + \frac{\Delta I_L}{2}$$

Under light-load conditions (below 100mA), use a larger inductance for improved efficiency.

Selecting the Input Capacitor

The input current to the step-down converter is discontinuous, therefore requires a capacitor to supply the AC current to the step-down converter and maintain the DC input voltage. Use low ESR capacitors; in particular ceramic capacitors with X5R or X7R dielectrics not only because of their low ESR values, but also their small temperature coefficients. A 22μF capacitor will suffice for most applications.

The input capacitor (C1) requires an adequate ripple current rating because it absorbs the input switching current. Estimate the RMS current in the input capacitor with:

$$I_{C1} = I_{LOAD} \times \sqrt{\frac{V_{OUT}}{V_{IN}} \times \left(1 - \frac{V_{OUT}}{V_{IN}}\right)}$$

The worst-case condition occurs at $V_{IN} = 2V_{OUT}$, where:

$$I_{C1} = \frac{I_{LOAD}}{2}$$

For simplification, choose an input capacitor with an RMS current rating greater than half the maximum load current.

The input capacitor can be electrolytic, tantalum or ceramic. When using electrolytic or tantalum capacitors, place a small, high-quality ceramic capacitor with a value of 0.1μF as close to the IC as possible. When using ceramic capacitors, select those with enough capacitance to prevent excessive input voltage ripple. Estimate the input voltage ripple caused by the capacitance with:

$$\Delta V_{IN} = \frac{I_{LOAD}}{f_s \times C1} \times \frac{V_{OUT}}{V_{IN}} \times \left(1 - \frac{V_{OUT}}{V_{IN}}\right)$$

Selecting the Output Capacitor

The output capacitor (C2) maintains the DC output voltage. Use ceramic, tantalum, or low-ESR electrolytic capacitors. Use low ESR capacitors in particular to keep the output voltage ripple low, as estimated by:

$$\Delta V_{OUT} = \frac{V_{OUT}}{f_s \times L_1} \times \left(1 - \frac{V_{OUT}}{V_{IN}}\right) \times \left(R_{ESR} + \frac{1}{8 \times f_s \times C2}\right)$$

Where L_1 is the inductor value and R_{ESR} is the equivalent series resistance (ESR) value of the output capacitor.

For ceramic capacitors, the capacitance dominates the impedance at the switching frequency and is the primary source of the output voltage ripple. For simplification, estimate the output voltage ripple with:

$$\Delta V_{OUT} = \frac{V_{OUT}}{8 \times f_s^2 \times L_1 \times C2} \times \left(1 - \frac{V_{OUT}}{V_{IN}}\right)$$

For tantalum or electrolytic capacitors, the ESR dominates the impedance at the switching frequency. For simplification, estimate the output ripple as:

$$\Delta V_{OUT} = \frac{V_{OUT}}{f_s \times L_1} \times \left(1 - \frac{V_{OUT}}{V_{IN}}\right) \times R_{ESR}$$

The characteristics of the output capacitor also affect the stability of the regulation system. The MP28266 can be optimized for a wide range of capacitance and ESR values.

Setting the AAM Voltage

The AAM voltage sets the transition point from AAM to CCM. Select a value that balances efficiency, stability, ripple, and transient response: A low AAM voltage improves stability and ripple, but degrades AAM Mode efficiency and transient response; Conversely, a high AAM voltage improves AAM efficiency and transient response, but degrades stability and ripple.

Set the AAM voltage using a resistor divider as shown in Figure 4.

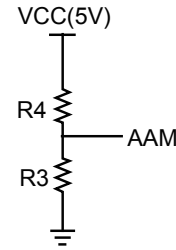

Figure 4: AAM Network

Normally, the converter has three operating modes: AAM, DCM, CCM. The boundary between DCM and CCM occurs when the inductor ripple minimum is zero. The input voltage, output voltage and inductance are all fixed, so to calculate the compensation voltage at the boundary between DCM and CCM ($V_{Critical_COMP}$), use the following equation:

$$I_{peak_Critical} = \frac{V_O (V_{IN} - V_O)}{V_{IN} \cdot L \cdot f_{OSC}}$$

$$V_{Critical_COMP} = \frac{I_{peak}}{G_{CS}} + V_{slope} + V_{is}$$

Where $G_{CS}=3.2A/V$, $V_{is}=0.21V$, and $V_{slope}=D$. D is the duty cycle.

If V_{AAM} exceeds $V_{Critical_COMP}$, the converter moves from AAM to CCM directly and eliminates DCM. This setting improves light-load efficiency. However, the output ripple increases during light-load. The inductor peak current at the transition point is:

$$I_{peak} = (V_{AAM} - V_{is} - V_{slope}) \cdot G_{CS}$$

If V_{AAM} is lower than $V_{Critical_COMP}$, the converter has three operating modes in the full load range. As the gap between V_{AAM} and $V_{Critical_COMP}$ narrows, so does the DCM range. To improve efficiency while retaining a reasonable ripple, set V_{AAM} close to $V_{Critical_COMP}$. The inductor peak current at this transition point is:

$$I_{peak} = \frac{(V_{AAM} - V_{is}) \cdot G_{CS} \cdot (V_{IN} - V_O)}{V_{IN} - V_O + L \cdot f_{OSC} \cdot G_{CS}}$$

Refer to Figure 5 to select an optimal voltage and then use the following equation to determine the value of R4. Assume R3 to be 10kΩ:

$$R4 = R3 \left(\frac{V_{CC}}{AAM} - 1 \right)$$

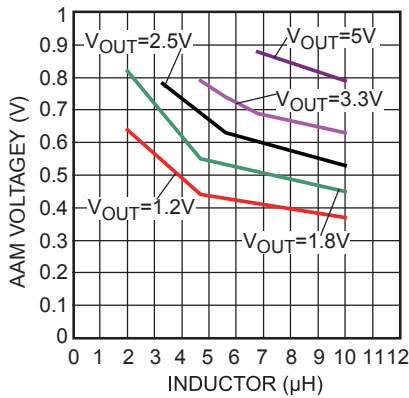

Figure 5: AAM Selection for Common Output Voltages (V_{IN}=6V-to-21V) External Bootstrap Diode

An external bootstrap diode can enhance the efficiency of the regulator given the applicable conditions:

- V_{OUT} is 5V or 3.3V; and
- Duty cycle is high: $D = \frac{V_{OUT}}{V_{IN}} > 65\%$

The external BST diode connects from the VCC pin to the BST pin, as shown in Figure 6.

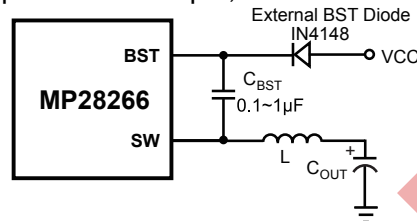
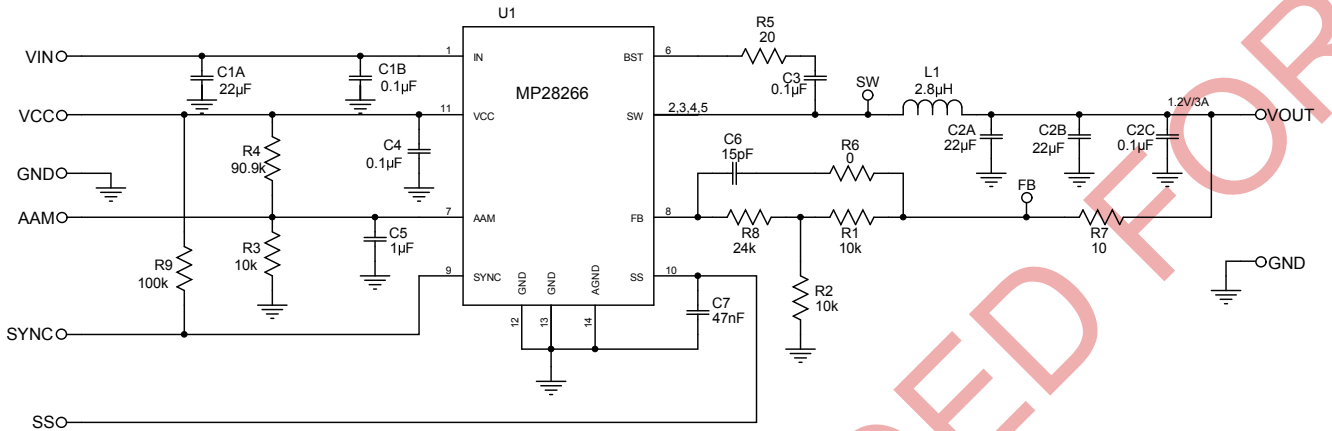

Figure 6: Optional External Bootstrap Diode for Enhanced Efficiency

The recommended external BST diode is IN4148, and the BST capacitor is 0.1μF to 1μF.

PC Board Layout

Place the high current paths (GND, IN and SW) very close to the device with short, direct, and wide traces. Place the input capacitor as close as possible to the IN and GND pins. Place the external feedback resistors next to the FB pin. Keep the switching node SW short and away from the feedback network.

TYPICAL APPLICATION CIRCUIT

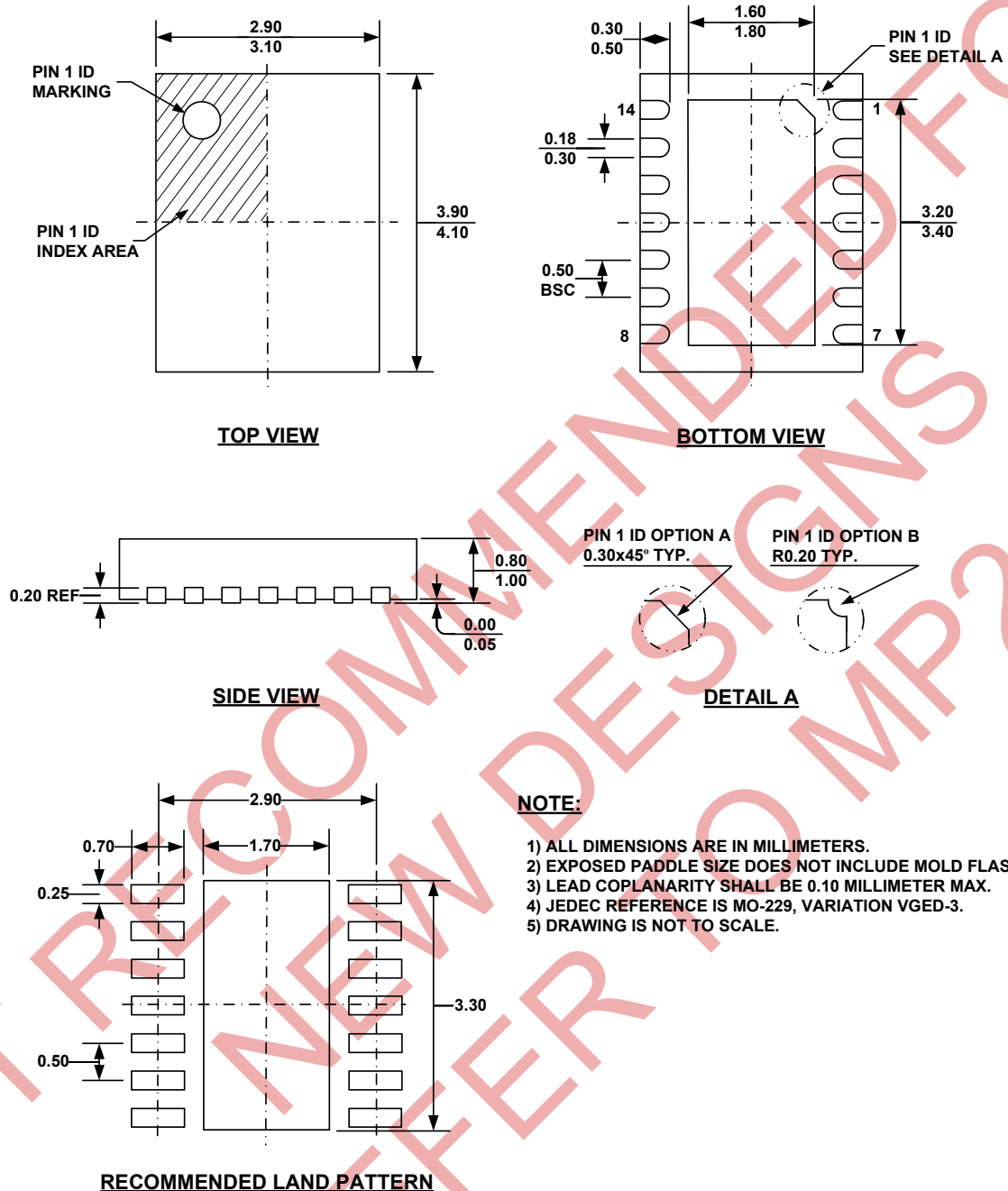
Figure 7: Typical Application Circuit

PACKAGE INFORMATION
QFN14 (3x4mm)

NOTICE: The information in this document is subject to change without notice. Please contact MPS for current specifications. Users should warrant and guarantee that third party Intellectual Property rights are not infringed upon when integrating MPS products into any application. MPS will not assume any legal responsibility for any said applications.