

**STEP-UP, 600 kHz, PWM CONTROL OR PWM/PFM  
SWITCHABLE SWITCHING REGULATOR CONTROLLER**[www.ablicinc.com](http://www.ablicinc.com)

© ABLIC Inc., 1999-2010

Rev.4.0\_02

The S-8340/8341 Series is a CMOS step-up switching regulator controller which mainly consists of a reference voltage source, oscillation circuit, error amplifier, phase compensation circuit, PWM control circuit (S-8340 Series), and PWM/PFM switching control circuit (S-8341 Series).

Since the oscillation frequency is a high 300 kHz or 600 kHz, with the addition of a small external part, the S-8340/8341 Series functions as a highly efficient step-up switching regulator with a high output current. The speed of the output stage is enhanced so that the N-channel power MOS with a low on-resistance can be switched quickly.

The S-8340 Series realizes low ripple, high efficiency, and excellent transient characteristics thanks to a PWM control circuit capable of varying the duty ratio linearly from 0 to 82%, optimized error amplifier, and phase compensation circuit.

The S-8341 Series contains a PWM/PFM switching control circuit so that it operates using PWM control with a duty ratio of 27% or higher and using PFM control with a duty ratio of lower than 27% to ensure high efficiency in all load ranges.

These S-8340/8341 Series serve as ideal main power supply units for portable devices when coupled with the 8-Pin TSSOP package and high oscillation frequencies.

**■ Features**

- Oscillation frequency : 600 kHz (A and B types), 300 kHz (C and D types).
- Output voltage : Selectable in 0.1 V steps between 2.5 to 6.0 V (output voltage fixed output type)
- Output voltage accuracy :  $\pm 2.0\%$
- Output voltage external setting (FB) type available. FB terminal voltage ( $V_{FB}$ ) 1.0 V
- External parts : Coil, diode, capacitors (3), transistor, and resistor only
- Duty ratio : 0 to 82% (typ.) PWM control (S-8340 Series)  
27 to 82% (typ.) PWM/PFM switching control (S-8341 Series A and B types)  
21 to 82% (typ.) PWM/PFM switching control (S-8341 Series C and D types)
- Low-voltage operation: Oscillation guaranteed to start when  $V_{DD} = 0.9$  V
- Built-in current limit circuit: Can be set with an external resistor ( $R_{SENSE}$ )
- Soft-start function set by an external capacitor ( $C_{SS}$ )
- Shutdown function
- Lead-free, Sn 100%, halogen-free\*1

\*1. Refer to "■ Product Name Structure" for details.

**■ Applications**

- Power supplies for portable equipments such as PDAs, electronic notebooks, and cellular phones
- Power supplies for audio equipments such as portable CD players, portable MD players, and headphone stereos
- Main or local power supplies for notebook PCs and peripherals
- Constant voltage power supplies for cameras, VCRs, and communication devices

**■ Package**

- 8-Pin TSSOP

■ Block Diagrams

(1) S-8340/8341 Series A and C Types (Output Voltage Fixed Output Type)

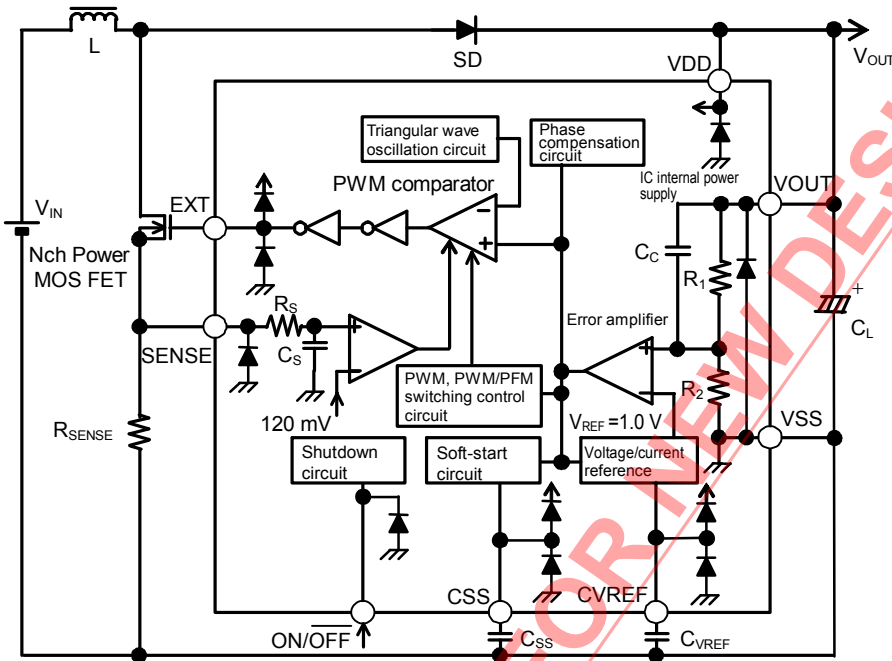

Figure 1

(2) S-8340/8341 Series B and D Types (Output Voltage External Setting Type)

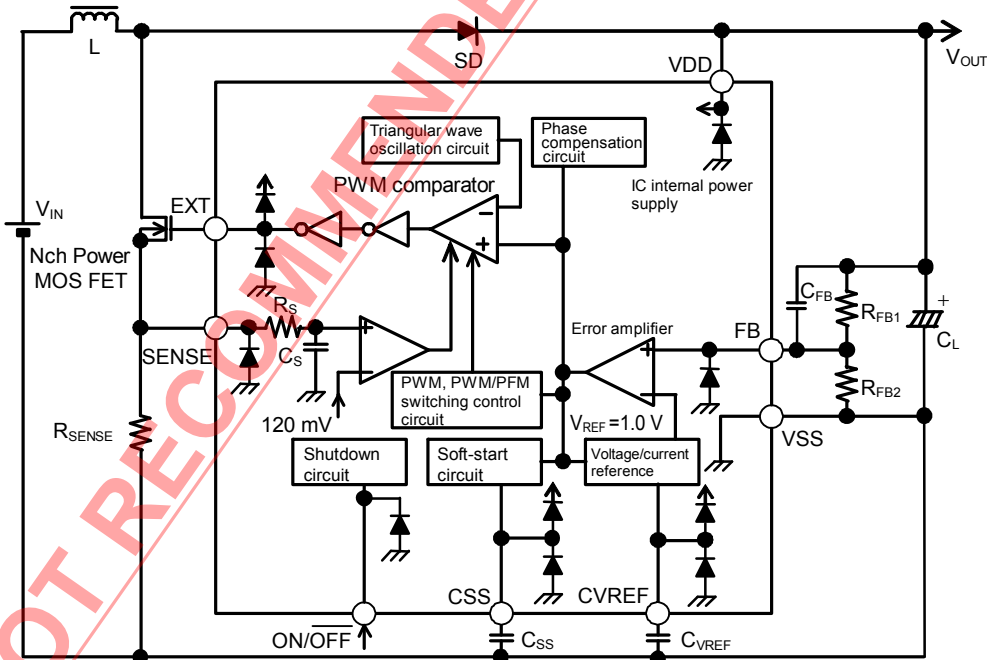
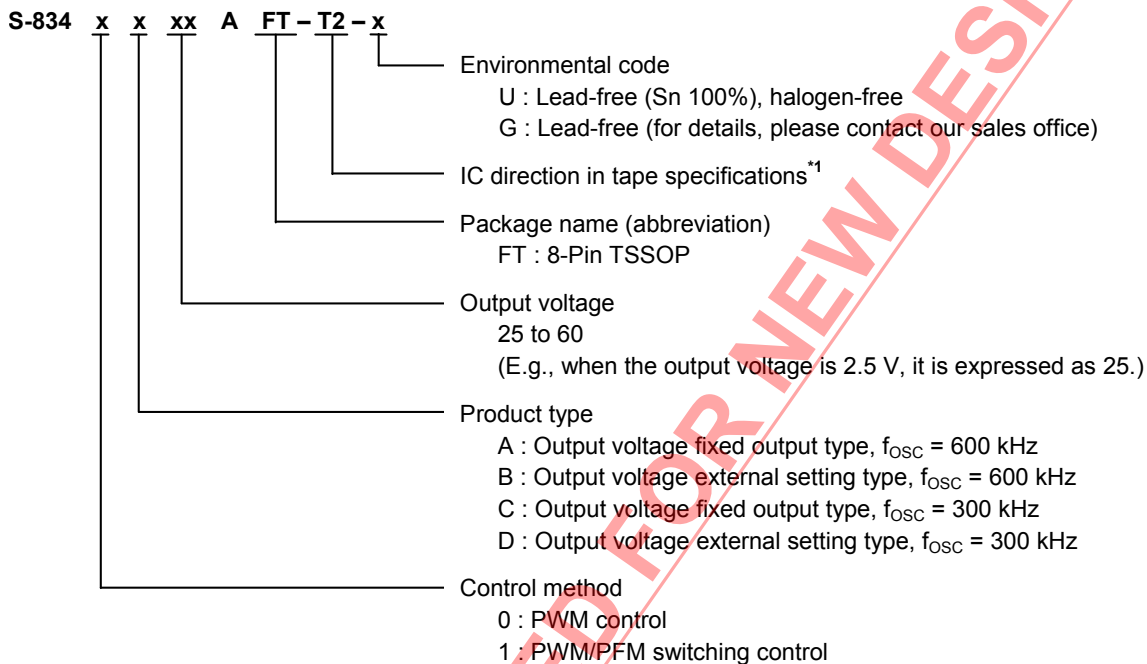

Figure 2

## ■ Product Name Structure

The control method, product type, and output voltage values for the S-8340/8341 Series can be selected depending on usage. Refer to “1. Product Name” for the definition of the product name, “2. Package” regarding the package drawings and “3. Product Name List” for the full product names.

### 1. Product Name



\*1. Refer to the tape drawing.

### 2. Package

Package Name		Drawing Code		
		Package	Tape	Reel
8-Pin TSSOP	Environmental code = G	FT008-A-P-SD	FT008-E-C-SD	FT008-E-R-SD
	Environmental code = U	FT008-A-P-SD	FT008-E-C-SD	FT008-E-R-S1

**3. Product Name List**

**(1) Output Voltage Fixed Output Type**

**Table 1**

Output Voltage (V)	S-8340 Series A Type $f_{OSC} = 600 \text{ kHz}$ PWM Control	S-8341 Series A Type $f_{OSC} = 600 \text{ kHz}$ PWM/PFM Switching Control	S-8340 Series C Type $f_{OSC} = 300 \text{ kHz}$ PWM Control	S-8341 Series C Type $f_{OSC} = 300 \text{ kHz}$ PWM/PFM Switching Control
2.5 V	S-8340A25AFT-T2-x	S-8341A25AFT-T2-x	S-8340C25AFT-T2-x	S-8341C25AFT-T2-x
3.0 V	S-8340A30AFT-T2-x	S-8341A30AFT-T2-x	S-8340C30AFT-T2-x	S-8341C30AFT-T2-x
3.3 V	S-8340A33AFT-T2-x	S-8341A33AFT-T2-x	S-8340C33AFT-T2-x	S-8341C33AFT-T2-x
3.4 V	S-8340A34AFT-T2-x	–	–	–
3.5 V	S-8340A35AFT-T2-x	–	–	–
5.0 V	S-8340A50AFT-T2-x	S-8341A50AFT-T2-x	S-8340C50AFT-T2-x	S-8341C50AFT-T2-x
5.1 V	S-8340A51AFT-T2-x	–	–	S-8341C51AFT-T2-x
5.6 V	S-8340A56AFT-T2-x	–	–	–
6.0 V	S-8340A60AFT-T2-x	–	S-8340C60AFT-T2-x	–

**Remark 1.** Contact the ABLIC Inc. marketing department for products with an output voltage other than those specified above.

2. x: G or U
3. Please select products of environmental code = U for Sn 100%, halogen-free products.

**(2) Output Voltage External Setting Type**

**Table 2**

Output Voltage (V)	S-8340 Series B Type $f_{OSC} = 600 \text{ kHz}$ PWM Control	S-8341 Series B Type $f_{OSC} = 600 \text{ kHz}$ PWM/PFM Switching Control	S-8340 Series D Type $f_{OSC} = 300 \text{ kHz}$ PWM Control	S-8341 Series D Type $f_{OSC} = 300 \text{ kHz}$ PWM/PFM Switching Control
External setting	S-8340B00AFT-T2-x	S-8341B00AFT-T2-x	S-8340D00AFT-T2-x	S-8341D00AFT-T2-x

**Remark 1.** x: G or U

2. Please select products of environmental code = U for Sn 100%, halogen-free products.

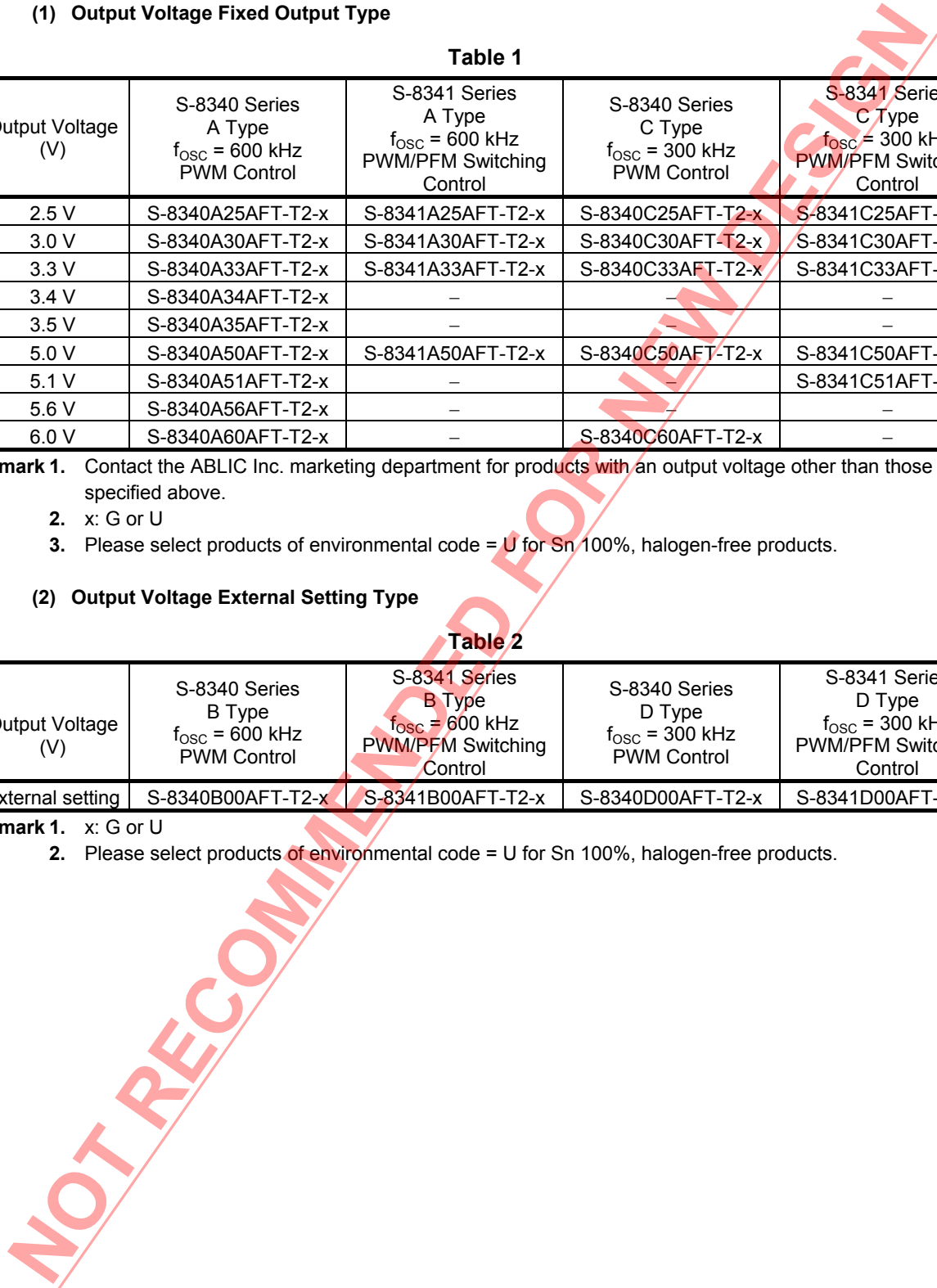

■ Pin Configurations

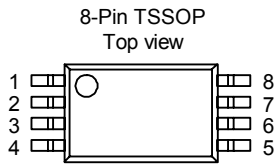

Figure 3

Table 3

Pin No.	Symbol	Pin Description
1	VSS	GND pin
2	CVREF	Reference voltage source pass capacitor connection pin
3	CSS	Soft-start capacitor connection pin
4	ON/OFF	Shutdown pin "H" : Normal operation (step-up operating) "L" : Entire circuit stopped (step-up stopped)
5	VDD	IC power supply pin
6	VOUT (FB)	Output voltage fixed output type : Output voltage monitoring pin [Output voltage external setting type : Feedback pin]
7	EXT	External transistor connection pin
8	SENSE	Current limit detection pin

NOT RECOMMENDED FOR NEW DESIGN

■ **Absolute Maximum Ratings**

**Table 4**

(Ta = 25°C unless otherwise specified)

Parameter	Symbol	Absolute Maximum Rating	Unit
VDD pin voltage	V <sub>DD</sub>	V <sub>SS</sub> - 0.3 to V <sub>SS</sub> + 12	V
VOOUT pin voltage	V <sub>OUT</sub>	V <sub>SS</sub> - 0.3 to V <sub>SS</sub> + 12	V
FB pin voltage	V <sub>FB</sub>	V <sub>SS</sub> - 0.3 to V <sub>SS</sub> + 12	V
CVREF pin voltage	V <sub>CVREF</sub>	V <sub>SS</sub> - 0.3 to V <sub>DD</sub> + 0.3	V
CSS pin voltage	V <sub>CSS</sub>	V <sub>SS</sub> - 0.3 to V <sub>DD</sub> + 0.3	V
ON/OFF pin voltage	V <sub>ON/OFF</sub>	V <sub>SS</sub> - 0.3 to V <sub>SS</sub> + 12	V
SENSE pin voltage	V <sub>SENSE</sub>	V <sub>SS</sub> - 0.3 to V <sub>SS</sub> + 12	V
EXT pin voltage	V <sub>EXT</sub>	V <sub>SS</sub> - 0.3 to V <sub>DD</sub> + 0.3	V
EXT pin current	I <sub>EXT</sub>	±100	mA
Power dissipation	P <sub>D</sub>	300 (When not mounted on board)	mW
		700*1	mW
Operating ambient temperature	T <sub>dpr</sub>	-40 to +85	°C
Storage temperature	T <sub>stg</sub>	-40 to +125	°C

\*1. When mounted on board

[Mounted board]

- (1) Board size : 114.3 mm × 76.2 mm × t1.6 mm
- (2) Board name : JEDEC STANDARD51-7

**Caution** The absolute maximum ratings are rated values exceeding which the product could suffer physical damage. These values must therefore not be exceeded under any conditions.

(1) When mounted on board

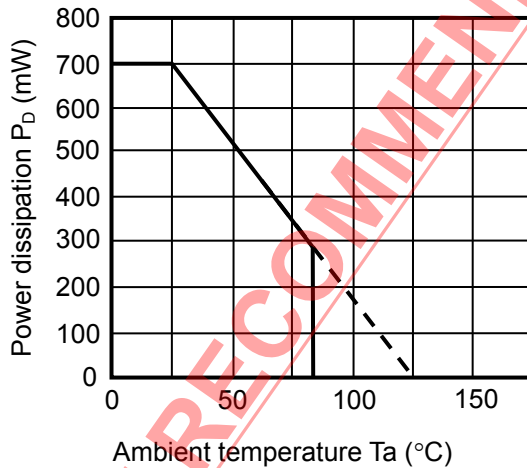

(2) When not mounted on board

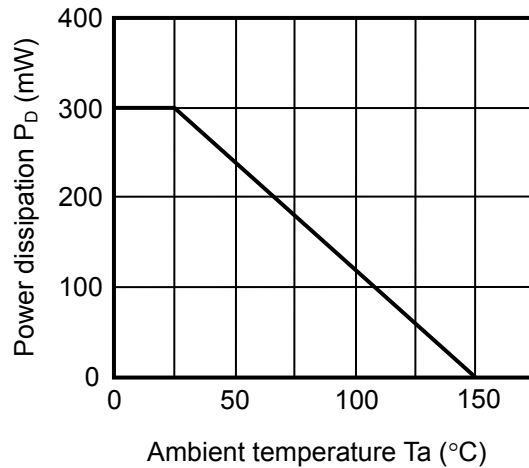

**Figure 4 Power Dissipation of Packages**

■ Electrical Characteristics

(1) 600 kHz, Output Voltage Fixed Type (A Type)

Table 5

(Ta = 25°C unless otherwise specified)

Parameter	Symbol	Conditions	Min.	Typ.	Max.	Unit	Measurement Circuit	
Output voltage <sup>1</sup>	V <sub>OUT(E)</sub>	V <sub>IN</sub> = V <sub>OUT(S)</sub> × 0.6, I <sub>OUT</sub> = V <sub>OUT(S)</sub> /50 Ω	V <sub>OUT(S)</sub> × 0.98	V <sub>OUT(S)</sub>	V <sub>OUT(S)</sub> × 1.02	V	1	
Input voltage	V <sub>IN</sub>	–	–	–	6	V	1	
Oscillation start voltage	V <sub>ST</sub>	No external parts. The voltage is applied to V <sub>OUT</sub> .	–	–	0.9	V	2	
Current consumption 1	I <sub>SS1</sub>	V <sub>OUT</sub> = V <sub>OUT(S)</sub> × 0.95, EXT pin open	S-834xA25 – 34	–	350	640	μA	2
			S-834xA35 – 44	–	460	810	μA	2
			S-834xA45 – 54	–	630	1060	μA	2
			S-834xA55 – 60	–	810	1250	μA	2
Current consumption 2	I <sub>SS2</sub>	V <sub>OUT</sub> = V <sub>OUT(S)</sub> + 0.5 V, EXT pin open	–	180	300	μA	2	
Current consumption at shutdown	I <sub>SSS</sub>	V <sub>OUT</sub> = V <sub>OUT(S)</sub> × 0.95, V <sub>ON/OFF</sub> = 0 V	–	–	3.0	μA	2	
EXT pin output current	I <sub>EXTH</sub>	V <sub>EXT</sub> = V <sub>OUT(E)</sub> – 0.2 V	S-834xA25 – 34	–13	–24	–	mA	–
			S-834xA35 – 44	–17	–30	–	mA	–
			S-834xA45 – 54	–21	–34	–	mA	–
			S-834xA55 – 60	–23	–37	–	mA	–
	I <sub>EXTL</sub>	V <sub>EXT</sub> = 0.2 V	S-834xA25 – 34	32	56	–	mA	–
			S-834xA35 – 44	42	69	–	mA	–
			S-834xA45 – 54	50	78	–	mA	–
			S-834xA55 – 60	56	85	–	mA	–
Line regulation	ΔV <sub>OUT1</sub>	V <sub>IN</sub> = V <sub>OUT(S)</sub> × 0.4 to V <sub>OUT(S)</sub> × 0.6 I <sub>OUT</sub> = V <sub>OUT(S)</sub> /50 Ω	–	V <sub>OUT(S)</sub> × 0.5%	V <sub>OUT(S)</sub> × 1%	V	1	
Load regulation	ΔV <sub>OUT2</sub>	V <sub>IN</sub> = V <sub>OUT(S)</sub> × 0.6, 10 μA ≤ I <sub>OUT</sub> ≤ V <sub>OUT(S)</sub> /40 Ω	–	V <sub>OUT(S)</sub> × 0.5%	V <sub>OUT(S)</sub> × 1%	V	1	
Output voltage temperature coefficient <sup>2</sup>	$\frac{\Delta V_{OUT}}{\Delta T_a \cdot V_{OUT}}$	V <sub>IN</sub> = V <sub>OUT(S)</sub> × 0.6, I <sub>OUT</sub> = V <sub>OUT(S)</sub> /50 Ω, Ta = –40 to +85°C	–	±100	–	ppm/°C	1	
Oscillation frequency	f <sub>OSC</sub>	V <sub>OUT</sub> = V <sub>OUT(S)</sub> × 0.95 Measure waveform at the EXT pin	510	600	690	kHz	2	
Maximum duty ratio	MaxDuty	V <sub>IN</sub> = V <sub>OUT(S)</sub> × 0.95 Measure waveform at the EXT pin	73	82	89	%	2	
PWM/PFM switching duty ratio (S-8341 Series A type)	PFMDuty	V <sub>IN</sub> = V <sub>OUT(E)</sub> – 0.1 V, under no load	19	27	35	%	1	
Current limit detection voltage	V <sub>SENSE</sub>	V <sub>OUT</sub> = V <sub>OUT(S)</sub> × 0.95 Judge oscillation at the EXT pin or oscillation stop at “L”	90	120	150	mV	2	
ON/OFF pin input voltage	V <sub>SH</sub>	V <sub>OUT</sub> = V <sub>OUT(S)</sub> × 0.95 Judge oscillation at the EXT pin.	0.8	–	–	V	2	
	V <sub>SL</sub>	V <sub>OUT</sub> = V <sub>OUT(S)</sub> × 0.95 Judge oscillation stop at the EXT pin.	–	–	0.3	V	2	
ON/OFF pin input leakage current	I <sub>SH</sub>	V <sub>OUT</sub> = 6 V, V <sub>ON/OFF</sub> = 6 V	–0.1	–	0.1	μA	2	
	I <sub>SL</sub>	V <sub>OUT</sub> = 6 V, V <sub>ON/OFF</sub> = 0 V	–0.1	–	0.1	μA	2	
Soft-start time	t <sub>SS</sub>	V <sub>IN</sub> = V <sub>OUT(S)</sub> × 0.6, C <sub>SS</sub> = 4700 pF, I <sub>OUT</sub> = V <sub>OUT(S)</sub> /50 Ω Measure time until oscillation occurs at the EXT pin.	S-8340Axx	3.0	6.0	14.0	ms	1
			S-8341Axx	3.0	8.0	14.0	ms	1
Efficiency	EFF1	V <sub>IN</sub> = V <sub>OUT(S)</sub> × 0.6, I <sub>OUT</sub> = V <sub>OUT(S)</sub> /50 Ω	S-834xA25 – 34	–	83	–	%	1
			S-834xA35 – 44	–	85	–	%	1
			S-834xA45 – 54	–	87	–	%	1
			S-834xA55 – 60	–	87	–	%	1

External parts	Coil :	Sumida Corporation CD54 (10 μH)
	Diode :	Matsushita Electronic Industrial Co., Ltd. MA735 (Schottky type)
	Capacitor :	Nichicon Corporation F93 (16 V, 47 μF, tantalum type)
	Transistor :	Sanyo Electric Co., Ltd. 2SD1628G
	Base resistor (R <sub>b</sub> ) :	1.0 kΩ
	Base capacitor (C <sub>b</sub> ) :	2200 pF (ceramic type)
	C <sub>VREF</sub> :	0.01 μF
	C <sub>SS</sub> :	4700 pF

The VDD pin is connected to the VOUT pin.

The ON/OFF pin is connected to the VOUT pin unless otherwise specified.

Connect the SENSE pin to the VSS pin.

\*1. V<sub>OUT(S)</sub> : Set output voltage value

V<sub>OUT(E)</sub> : Actual output voltage value : Output voltage value when I<sub>OUT</sub> = V<sub>OUT(S)</sub>/50 Ω and V<sub>IN</sub> = V<sub>OUT(S)</sub> × 0.6.

\*2. The change of output voltage with temperature [mV/°C] is calculated from the following formula.

$$\frac{\Delta V_{OUT}}{\Delta T_a} \text{ [mV/°C]} = V_{OUT(S)} \text{ [V]} \times \frac{\Delta V_{OUT}}{\Delta T_a \cdot V_{OUT}} \text{ [ppm/°C]} \div 1000$$

(Change of output voltage with temperature) (Set output voltage value) (Output voltage temperature coefficient)

**Caution** The S-8340/8341 Series steps up from V<sub>DD</sub> = 0.9 V. However, 2.5 V or more for V<sub>DD</sub> is recommended to stabilize the output voltage and oscillation frequency. If V<sub>DD</sub> is taken from V<sub>IN</sub> or other power sources, instead of V<sub>OUT</sub>, V<sub>DD</sub> should be 2.5 V or more. However, if V<sub>DD</sub> is not taken from V<sub>OUT</sub>, note that the output voltage accuracy of ±2.0% is not guaranteed due to dependency of output voltage on V<sub>DD</sub>. In particular, accuracy of output voltage is degraded significantly when the V<sub>DD</sub> voltage is 6.0 V or more. Therefore, do not use this IC when the V<sub>DD</sub> voltage is 6.0 V or more. If V<sub>DD</sub> of 2.5 V or more is applied, increase power supply so that V<sub>DD</sub> becomes 2.5 V or more within the soft-start time (3.0 ms).

NOT RECOMMENDED FOR NEW DESIGN



(2) 600 kHz, Output Voltage External Setting Type (B Type)

Table 6

(Ta = 25°C unless otherwise specified)

Parameter	Symbol	Conditions	Min.	Typ.	Max.	Unit	Measurement Circuit	
Output voltage <sup>*1</sup>	V <sub>OUT(E)</sub>	V <sub>IN</sub> = 2.4 V, I <sub>OUT</sub> = 80 mA	3.920	4.000	4.080	V	3	
FB pin voltage	V <sub>FB</sub>	V <sub>IN</sub> = 2.4 V, I <sub>OUT</sub> = 80 mA	0.980	1.000	1.020	V	3	
Input voltage	V <sub>IN</sub>	–	–	–	6	V	3	
Oscillation start voltage	V <sub>ST2</sub>	No external parts. The voltage is applied to V <sub>DD</sub> .	–	–	0.9	V	4	
Current consumption 1	I <sub>SS1</sub>	V <sub>OUT</sub> = 3.8 V	–	460	740	μA	4	
Current consumption 2	I <sub>SS2</sub>	V <sub>OUT</sub> = 4.5 V	–	180	300	μA	4	
Current consumption at shutdown	I <sub>SSS</sub>	V <sub>OUT</sub> = 3.8 V, V <sub>ON/OFF</sub> = 0 V	–	–	3.0	μA	4	
EXT pin output current	I <sub>EXTH</sub>	V <sub>EXT</sub> = V <sub>OUT(E)</sub> – 0.2 V	–19	–30	–	mA	–	
	I <sub>EXTL</sub>	V <sub>EXT</sub> = 0.2 V	46	69	–	mA	–	
Line regulation	ΔV <sub>OUT1</sub>	1.6 V ≤ V <sub>IN</sub> ≤ 2.4 V, I <sub>OUT</sub> = 80 mA	–	20	40	mV	3	
Load regulation	ΔV <sub>OUT2</sub>	V <sub>IN</sub> = 2.4 V, 10 μA ≤ I <sub>OUT</sub> ≤ 100 mA	–	20	40	mV	3	
Output voltage temperature coefficient <sup>*2</sup>	$\frac{\Delta V_{OUT}}{\Delta Ta \cdot V_{OUT}}$	V <sub>IN</sub> = 2.4 V, I <sub>OUT</sub> = 80 mA, Ta = –40 to +85°C	–	±100	–	ppm/°C	3	
Oscillation frequency	f <sub>OSC</sub>	V <sub>OUT</sub> = 3.8 V, measure waveform at the EXT pin	510	600	690	kHz	4	
Maximum duty ratio	MaxDuty	V <sub>IN</sub> = 3.8 V, measure waveform at the EXT pin	73	82	89	%	4	
PWM/PFM switching duty ratio (S-8341 Series B type)	PFMDuty	V <sub>IN</sub> = V <sub>OUT(E)</sub> – 0.1 V, under no load	19	27	35	%	3	
Current limit detection voltage	V <sub>SENSE</sub>	V <sub>OUT</sub> = 3.8 V Judge oscillation at the EXT pin or oscillation stop at “L”	90	120	150	mV	4	
FB pin input current	I <sub>FB</sub>	V <sub>OUT</sub> = 6 V, V <sub>FB</sub> = 1.5 V	–50	–	50	nA	4	
ON/OFF pin input voltage	V <sub>SH</sub>	V <sub>OUT</sub> = 3.8 V Judge oscillation at the EXT pin.	0.8	–	–	V	4	
	V <sub>SL</sub>	V <sub>OUT</sub> = 3.8 V Judge oscillation stop at the EXT pin.	–	–	0.3	V	4	
ON/OFF pin input leakage current	I <sub>SH</sub>	V <sub>OUT</sub> = 6 V, V <sub>ON/OFF</sub> = 6 V	–0.1	–	0.1	μA	4	
	I <sub>SL</sub>	V <sub>OUT</sub> = 6 V, V <sub>ON/OFF</sub> = 0 V	–0.1	–	0.1	μA	4	
Soft-start time	t <sub>SS</sub>	V <sub>IN</sub> = 2.4 V, C <sub>SS</sub> = 4700 pF, I <sub>OUT</sub> = 80 mA, Measure time until oscillation occurs at the EXT pin.	S-8340B00	3.0	6.0	14.0	ms	3
			S-8341B00	3.0	8.0	14.0	ms	3
Efficiency	EFF1	V <sub>IN</sub> = 2.4 V, I <sub>OUT</sub> = 80 mA	–	85	–	%	3	

External parts	Coil :	Sumida Corporation CD54 (10 μH)
	Diode :	Matsushita Electronic Industrial Co., Ltd. MA735 (Schottky type)
	Capacitor :	Nichicon Corporation F93 (16 V, 47 μF, tantalum type)
	Transistor :	Sanyo Electric Co., Ltd. 2SD1628G
	Base resistor (R <sub>b</sub> ) :	1.0 kΩ
	Base capacitor (C <sub>b</sub> ) :	2200 pF (ceramic type)
	C <sub>VREF</sub> :	0.01 μF
	C <sub>SS</sub> :	4700 pF
	R <sub>FB1</sub> :	300 kΩ
	R <sub>FB2</sub> :	100 kΩ
	C <sub>FB</sub> :	50 pF

The ON/OFF pin is connected to the VOUT pin unless otherwise specified.  
 Connect the SENSE pin to the VSS pin.

\*1. V<sub>OUT(E)</sub> : Actual output voltage value : Output voltage value when I<sub>OUT</sub> = 80 mA and V<sub>IN</sub> = 2.4 V is applied.

The Typ. value (set output voltage value) is  $1 + \frac{300 \text{ k}\Omega}{100 \text{ k}\Omega} [V]$

\*2. The change of output voltage with temperature [mV/°C] is calculated from the following formula. However, the temperature change rates for R<sub>FB1</sub> and R<sub>FB2</sub> are assumed to be the same.

$$\frac{\Delta V_{OUT}}{\Delta T_a} [mV/^\circ C] = \left(1 + \frac{R_{FB1}}{R_{FB2}}\right) \times \frac{\Delta V_{OUT}}{\Delta T_a \cdot V_{OUT}} [ppm/^\circ C] \div 1000$$

(Change of output voltage with temperature)      (Set output voltage value)      (Output voltage temperature coefficient)

**Caution** The S-8340/8341 Series steps up from V<sub>DD</sub> = 0.9 V. However, 2.5 V or more for V<sub>DD</sub> is recommended to stabilize the output voltage and oscillation frequency. If V<sub>DD</sub> is taken from V<sub>IN</sub> or other power sources, instead of V<sub>OUT</sub>, V<sub>DD</sub> should be 2.5 V or more. However, if V<sub>DD</sub> is other than 4.0 V, note that the output voltage accuracy of ±2.0% is not guaranteed due to dependency of output voltage on V<sub>DD</sub>. In particular, accuracy of output voltage is degraded significantly when the V<sub>DD</sub> voltage is 6.0 V or more. Therefore, do not use this IC when the V<sub>DD</sub> voltage is 6.0 V or more. If V<sub>DD</sub> of 2.5 V or more is applied, increase power supply so that V<sub>DD</sub> becomes 2.5 V or more within the soft-start time (3.0 ms).

NOT RECOMMENDED FOR NEW DESIGN

(3) 300 kHz, Output Voltage Fixed Type (C Type)

Table 7

(Ta = 25°C unless otherwise specified)

Parameter	Symbol	Conditions	Min.	Typ.	Max.	Unit	Measurement Circuit	
Output voltage <sup>*1</sup>	V <sub>OUT(E)</sub>	V <sub>IN</sub> = V <sub>OUT(S)</sub> × 0.6, I <sub>OUT</sub> = V <sub>OUT(S)</sub> /50 Ω	V <sub>OUT(S)</sub> × 0.98	V <sub>OUT(S)</sub>	V <sub>OUT(S)</sub> × 1.02	V	1	
Input voltage	V <sub>IN</sub>	–	–	–	6	V	1	
Oscillation start voltage	V <sub>ST</sub>	No external parts. The voltage is applied to V <sub>OUT</sub> .	–	–	0.9	V	2	
Current consumption 1	I <sub>SS1</sub>	V <sub>OUT</sub> = V <sub>OUT(S)</sub> × 0.95, EXT pin open	S-834xC25 – 34	–	210	430	μA	2
			S-834xC35 – 44	–	270	520	μA	2
			S-834xC45 – 54	–	350	650	μA	2
			S-834xC55 – 60	–	440	740	μA	2
Current consumption 2	I <sub>SS2</sub>	V <sub>OUT</sub> = V <sub>OUT(S)</sub> + 0.5 V, EXT pin open	–	110	185	μA	2	
Current consumption at shutdown	I <sub>SSS</sub>	V <sub>OUT</sub> = V <sub>OUT(S)</sub> × 0.95, V <sub>ON/OFF</sub> = 0 V	–	–	3.0	μA	2	
EXT pin output current	I <sub>EXTH</sub>	V <sub>EXT</sub> = V <sub>OUT(E)</sub> – 0.2 V	S-834xC25 – 34	–13	–24	–	mA	–
			S-834xC35 – 44	–17	–30	–	mA	–
			S-834xC45 – 54	–21	–34	–	mA	–
			S-834xC55 – 60	–23	–37	–	mA	–
	I <sub>EXTL</sub>	V <sub>EXT</sub> = 0.2 V	S-834xC25 – 34	32	56	–	mA	–
			S-834xC35 – 44	42	69	–	mA	–
			S-834xC45 – 54	50	78	–	mA	–
			S-834xC55 – 60	56	85	–	mA	–
Line regulation	ΔV <sub>OUT1</sub>	V <sub>IN</sub> = V <sub>OUT(S)</sub> × 0.4 to V <sub>OUT(S)</sub> × 0.6 I <sub>OUT</sub> = V <sub>OUT(S)</sub> /50 Ω	–	V <sub>OUT(S)</sub> × 0.5%	V <sub>OUT(S)</sub> × 1%	V	1	
Load regulation	ΔV <sub>OUT2</sub>	V <sub>IN</sub> = V <sub>OUT(S)</sub> × 0.6, 10 μA ≤ I <sub>OUT</sub> ≤ V <sub>OUT(S)</sub> /40 Ω	–	V <sub>OUT(S)</sub> × 0.5%	V <sub>OUT(S)</sub> × 1%	V	1	
Output voltage temperature coefficient <sup>*2</sup>	$\frac{\Delta V_{OUT}}{\Delta T_a \cdot V_{OUT}}$	V <sub>IN</sub> = V <sub>OUT(S)</sub> × 0.6, I <sub>OUT</sub> = V <sub>OUT(S)</sub> /50 Ω Ta = –40 to +85°C	–	±100	–	ppm/°C	1	
Oscillation frequency	f <sub>OSC</sub>	V <sub>OUT</sub> = V <sub>OUT(S)</sub> × 0.95 Measure waveform at the EXT pin	255	300	345	kHz	2	
Maximum duty ratio	MaxDuty	V <sub>IN</sub> = V <sub>OUT(S)</sub> × 0.95 Measure waveform at the EXT pin	73	82	89	%	2	
PWM/PFM switching duty ratio (S-8341 Series C type)	PFMDuty	V <sub>IN</sub> = V <sub>OUT(E)</sub> – 0.1 V, under no load	15	21	31	%	1	
Current limit detection voltage	V <sub>SENSE</sub>	V <sub>OUT</sub> = V <sub>OUT(S)</sub> × 0.95 Judge oscillation at the EXT pin or oscillation stop at "L"	90	120	150	mV	2	
ON/OFF pin input voltage	V <sub>SH</sub>	V <sub>OUT</sub> = V <sub>OUT(S)</sub> × 0.95 Judge oscillation at the EXT pin.	0.8	–	–	V	2	
	V <sub>SL</sub>	V <sub>OUT</sub> = V <sub>OUT(S)</sub> × 0.95 Judge oscillation stop at the EXT pin.	–	–	0.3	V	2	
ON/OFF pin input leakage current	I <sub>SH</sub>	V <sub>OUT</sub> = 6 V, V <sub>ON/OFF</sub> = 6 V	–0.1	–	0.1	μA	2	
	I <sub>SL</sub>	V <sub>OUT</sub> = 6 V, V <sub>ON/OFF</sub> = 0 V	–0.1	–	0.1	μA	2	
Soft-start time	t <sub>SS</sub>	V <sub>IN</sub> = V <sub>OUT(S)</sub> × 0.6, C <sub>SS</sub> = 4700 pF, I <sub>OUT</sub> = V <sub>OUT(S)</sub> /50 Ω, Measure time until oscillation occurs at EXT pin.	S-8340Cxx	6.0	14.3	28.0	ms	1
			S-8341Cxx	6.0	17.2	28.0	ms	1
Efficiency	EFFI	V <sub>IN</sub> = V <sub>OUT(S)</sub> × 0.6, I <sub>OUT</sub> = V <sub>OUT(S)</sub> /50 Ω	S-834xC25 – 34	–	83	–	%	1
			S-834xC35 – 44	–	85	–	%	1
			S-834xC45 – 54	–	87	–	%	1
			S-834xC55 – 60	–	87	–	%	1

External parts	Coil :	Sumida Corporation CD54 (10 μH)
	Diode :	Matsushita Electronic Industrial Co., Ltd. MA735 (Schottky type)
	Capacitor :	Nichicon Corporation F93 (16 V, 47 μF, tantalum type)
	Transistor :	Sanyo Electric Co., Ltd. 2SD1628G
	Base resistor (R <sub>b</sub> ) :	1.0 kΩ
	Base capacitor (C <sub>b</sub> ) :	2200 pF (ceramic type)
	C <sub>VREF</sub> :	0.01 μF
	C <sub>SS</sub> :	4700 pF

The VDD pin is connected to the VOUT pin.

The ON/OFF pin is connected to the VOUT pin unless otherwise specified.

Connect the SENSE pin to the VSS pin.

\*1. V<sub>OUT(S)</sub> : Set output voltage value

V<sub>OUT(E)</sub> : Actual output voltage value : Output voltage value when I<sub>OUT</sub> = V<sub>OUT(S)</sub>/50 Ω and V<sub>IN</sub> = V<sub>OUT(S)</sub> × 0.6.

\*2. The change of output voltage with temperature [mV/°C] is calculated from the following formula.

$$\frac{\Delta V_{OUT}}{\Delta T_a} \text{ [mV/°C]} = V_{OUT(S)} \text{ [V]} \times \frac{\Delta V_{OUT}}{\Delta T_a \cdot V_{OUT}} \text{ [ppm/°C]} \div 1000$$

(Change of output voltage with temperature)	(Set output voltage value)	(Output voltage temperature coefficient)
--	-------------------------------	---

**Caution** The S-8340/8341 Series steps up from V<sub>DD</sub> = 0.9 V. However, 2.5 V or more for V<sub>DD</sub> is recommended to stabilize the output voltage and oscillation frequency. If V<sub>DD</sub> is taken from V<sub>IN</sub> or other power sources, instead of V<sub>OUT</sub>, V<sub>DD</sub> should be 2.5 V or more. However, if V<sub>DD</sub> is not taken from V<sub>OUT</sub>, note that the output voltage accuracy of ±2.0% is not guaranteed due to dependency of output voltage on V<sub>DD</sub>. In particular, accuracy of output voltage is degraded significantly when the V<sub>DD</sub> voltage is 6.0 V or more. Therefore, do not use this IC when the V<sub>DD</sub> voltage is 6.0 V or more. If V<sub>DD</sub> of 2.5 V or more is applied, increase power supply so that V<sub>DD</sub> becomes 2.5 V or more within the soft-start time (6.0 ms).

NOT RECOMMENDED FOR NEW DESIGN

(4) 300 kHz, Output Voltage External Setting Type (D Type)

Table 8

(Ta = 25°C unless otherwise specified)

Parameter	Symbol	Conditions	Min.	Typ.	Max.	Unit	Measurement Circuit	
Output voltage <sup>*1</sup>	V <sub>OUT(E)</sub>	V <sub>IN</sub> = 2.4 V, I <sub>OUT</sub> = 80 mA	3.920	4.000	4.080	V	3	
FB pin voltage	V <sub>FB</sub>	V <sub>IN</sub> = 2.4 V, I <sub>OUT</sub> = 80 mA	0.980	1.000	1.020	V	3	
Input voltage	V <sub>IN</sub>	–	–	–	6	V	3	
Oscillation start voltage	V <sub>ST2</sub>	No external parts. The voltage is applied to V <sub>DD</sub> .	–	–	0.9	V	4	
Current consumption 1	I <sub>SS1</sub>	V <sub>OUT</sub> = 3.8 V	–	255	460	μA	4	
Current consumption 2	I <sub>SS2</sub>	V <sub>OUT</sub> = 4.5 V	–	110	185	μA	4	
Current consumption at shutdown	I <sub>SSS</sub>	V <sub>OUT</sub> = 3.8 V, V <sub>ON/OFF</sub> = 0 V	–	–	3.0	μA	4	
EXT pin output current	I <sub>EXTH</sub>	V <sub>EXT</sub> = V <sub>OUT(E)</sub> – 0.2 V	–19	–30	–	mA	–	
	I <sub>EXTL</sub>	V <sub>EXT</sub> = 0.2 V	46	69	–	mA	–	
Line regulation	ΔV <sub>OUT1</sub>	1.6 V ≤ V <sub>IN</sub> ≤ 2.4 V, I <sub>OUT</sub> = 80 mA	–	20	40	mV	3	
Load regulation	ΔV <sub>OUT2</sub>	V <sub>IN</sub> = 2.4 V, 10 μA ≤ I <sub>OUT</sub> ≤ 100 mA	–	20	40	mV	3	
Output voltage temperature coefficient <sup>*2</sup>	$\frac{\Delta V_{OUT}}{\Delta Ta \cdot V_{OUT}}$	V <sub>IN</sub> = 2.4 V, I <sub>OUT</sub> = 80 mA, Ta = –40 to +85°C	–	±100	–	ppm/°C	3	
Oscillation frequency	f <sub>OSC</sub>	V <sub>OUT</sub> = 3.8 V, Measure waveform at the EXT pin	255	300	345	kHz	4	
Maximum duty ratio	MaxDuty	V <sub>IN</sub> = 3.8 V, Measure waveform at the EXT pin	73	82	89	%	4	
PWM/PFM switching duty ratio (S-8341 Series D type)	PFMDuty	V <sub>IN</sub> = V <sub>OUT(E)</sub> – 0.1 V, Under no load	15	21	31	%	3	
Current limit detection voltage	V <sub>SENSE</sub>	V <sub>OUT</sub> = 3.8 V Judge oscillation at the EXT pin or oscillation stop at “L”	90	120	150	mV	4	
FB pin input current	I <sub>FB</sub>	V <sub>OUT</sub> = 6 V, V <sub>FB</sub> = 1.5 V	–50	–	50	nA	4	
ON/OFF pin input voltage	V <sub>SH</sub>	V <sub>OUT</sub> = 3.8 V Judge oscillation at the EXT pin.	0.8	–	–	V	4	
	V <sub>SL</sub>	V <sub>OUT</sub> = 3.8 V Judge oscillation stop at the EXT pin.	–	–	0.3	V	4	
ON/OFF pin input leakage current	I <sub>SH</sub>	V <sub>OUT</sub> = 6 V, V <sub>ON/OFF</sub> = 6 V	–0.1	–	0.1	μA	4	
	I <sub>SL</sub>	V <sub>OUT</sub> = 6 V, V <sub>ON/OFF</sub> = 0 V	–0.1	–	0.1	μA	4	
Soft-start time	t <sub>SS</sub>	V <sub>IN</sub> = 2.4 V, C <sub>SS</sub> = 4700 pF, I <sub>OUT</sub> = 80 mA, Measure time until oscillation occurs at the EXT pin.	S-8340D00	6.0	14.3	28.0	ms	3
			S-8341D00	6.0	17.2	28.0	ms	3
Efficiency	EFF1	V <sub>IN</sub> = 2.4 V, I <sub>OUT</sub> = 80 mA	–	85	–	%	3	

External parts	Coil :	Sumida Corporation CD54 (10 μH)
	Diode :	Matsushita Electronic Industrial Co., Ltd. MA735 (Schottky type)
	Capacitor :	Nichicon Corporation F93 (16 V, 47 μF, tantalum type)
	Transistor :	Sanyo Electric Co., Ltd. 2SD1628G
	Base resistor (R <sub>b</sub> ) :	1.0 kΩ
	Base capacitor (C <sub>b</sub> ) :	2200 pF (ceramic type)
	C <sub>VREF</sub> :	0.01 μF
	C <sub>SS</sub> :	4700 pF
	R <sub>FB1</sub> :	300 kΩ
	R <sub>FB2</sub> :	100 kΩ
	C <sub>FB</sub> :	50 pF

The ON/OFF pin is connected to the VOUT pin unless otherwise specified.  
 Connect the SENSE pin to the VSS pin.

\*1. V<sub>OUT(E)</sub> : Actual output voltage value : Output voltage value when I<sub>OUT</sub> = 80 mA and V<sub>IN</sub> = 2.4 V is applied.

The Typ. value (set output voltage value) is  $1 + \frac{300 \text{ k}\Omega}{100 \text{ k}\Omega} [V]$

\*2. The change of output voltage with temperature [mV/°C] is calculated from the following formula. However, the temperature change rates for R<sub>FB1</sub> and R<sub>FB2</sub> are assumed to be the same.

$$\frac{\Delta V_{OUT}}{\Delta T_a} [mV/^\circ C] = \left(1 + \frac{R_{FB1}}{R_{FB2}}\right) \times \frac{\Delta V_{OUT}}{\Delta T_a \cdot V_{OUT}} [ppm/^\circ C] \div 1000$$

(Change of output voltage with temperature)    (Set output voltage value)    (Output voltage temperature coefficient)

**Caution** The S-8340/8341 Series steps up from V<sub>DD</sub> = 0.9 V. However, 2.5 V or more for V<sub>DD</sub> is recommended to stabilize the output voltage and oscillation frequency. If V<sub>DD</sub> is taken from V<sub>IN</sub> or other power sources, instead of V<sub>OUT</sub>, V<sub>DD</sub> should be 2.5 V or more. However, if V<sub>DD</sub> is other than 4.0 V, note that the output voltage accuracy of ±2.0% is not guaranteed due to dependency of output voltage on V<sub>DD</sub>. In particular, accuracy of output voltage is degraded significantly when the V<sub>DD</sub> voltage is 6.0 V or more. Therefore, do not use this IC when the V<sub>DD</sub> voltage is 6.0 V or more. If V<sub>DD</sub> of 2.5 V or more is applied, increase power supply so that V<sub>DD</sub> becomes 2.5 V or more within the soft-start time (6.0 ms).

NOT RECOMMENDED FOR NEW DESIGN

■ Measurement Circuits

1.

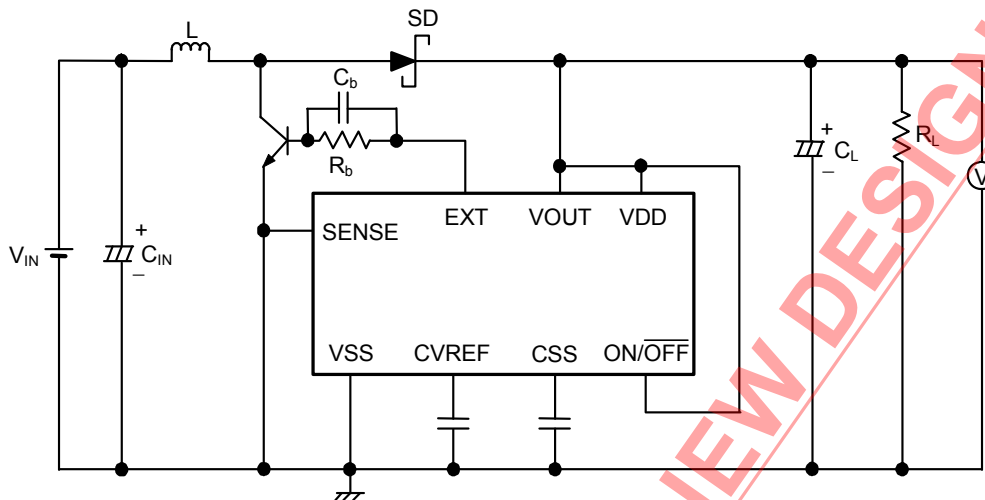

Figure 5

2.

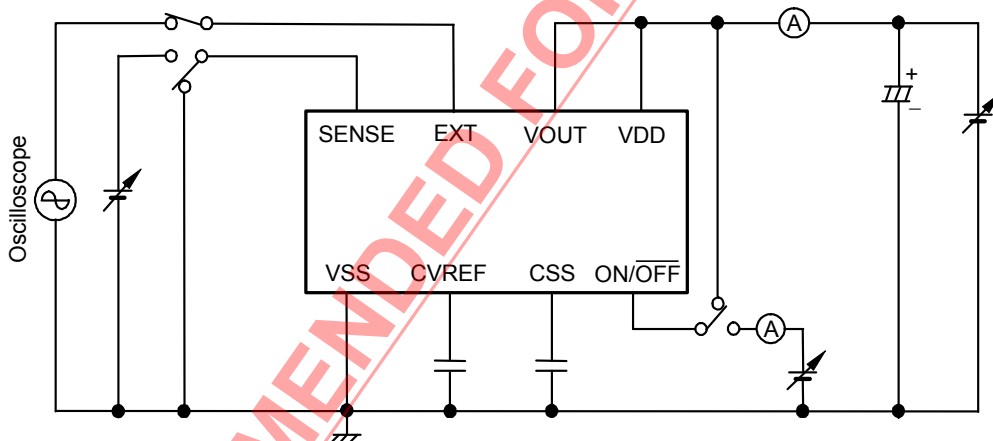

Figure 6

3.

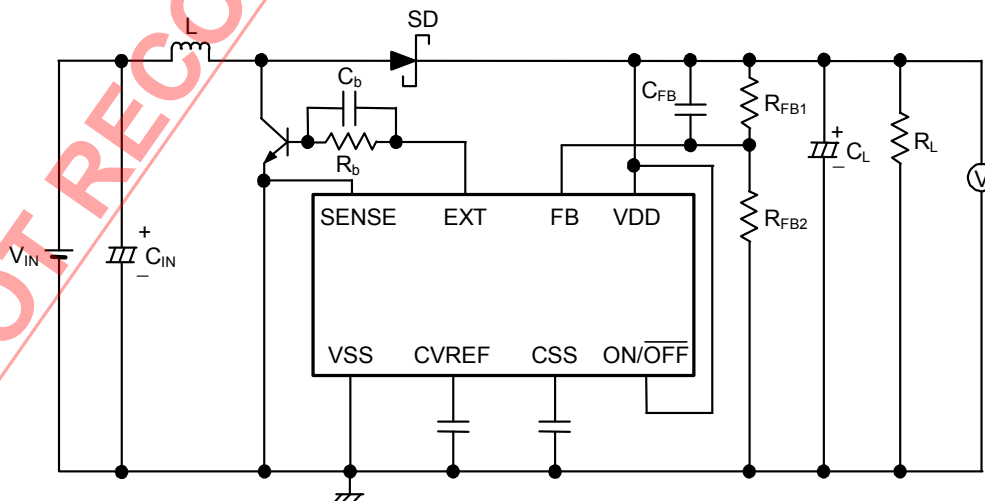

Figure 7

4.

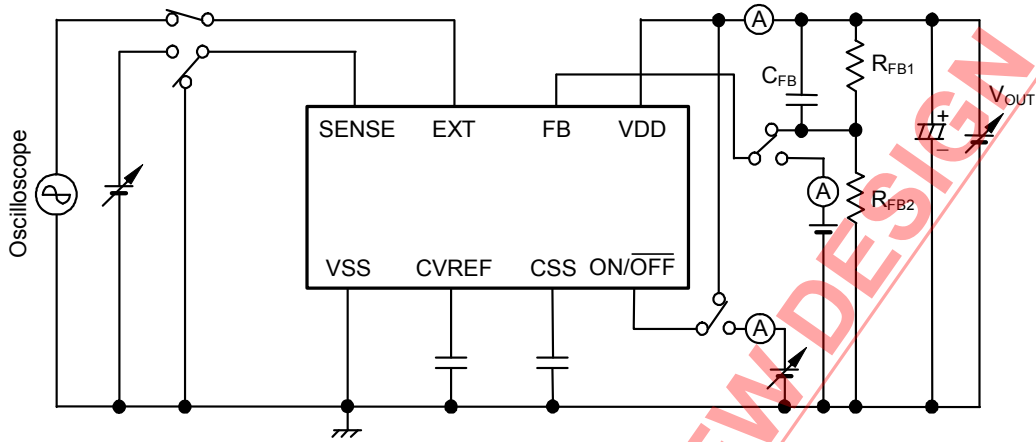

Figure 8

**NOT RECOMMENDED FOR NEW DESIGN**



■ Operation

1. Switching Control Method

1.1 PWM Control (S-8340 Series)

The S-8340 Series is a DC-DC converter using a pulse width modulation method (PWM). In conventional PFM DC-DC converters, pulses are skipped when the output load current is low, causing a fluctuation in the ripple frequency of the output voltage, resulting in an increase in the ripple voltage. The switching frequency does not change, although the pulse width changes from 0 to 82% corresponding to each load current in the S-8340 Series. The ripple voltage generated from switching can thus be eliminated easily through a filter. When the pulse width is 0% (when no load is applied or the input voltage is high), pulses are skipped and the current consumption is low.

1.2 PWM/PFM Switching Control (S-8341 Series)

The S-8341 Series is a DC-DC converter that automatically switches between a pulse width modulation method (PWM) and a pulse frequency modulation method (PFM) depending on the load current. The S-8341 Series operates under PWM control with the pulse duty changing from 27 to 82% (A and B types) and from 21 to 82% (C and D types) in a high output load current area. The S-8341 Series operates under PFM control with the pulse duty fixed at 27% (A and B types) and at 21% (C and D types) in a low load current area, and pulses are skipped according to the load current. The oscillation circuit thus oscillates intermittently so that the resultant lower self current consumption prevents a reduction in the efficiency at a low load current. The switching point from PWM control to PFM control depends on the external devices (coil, diode, etc.), and input and output voltage values. The S-8341 Series is an especially highly efficient DC-DC converter at an output load current around 1 mA.

2. Soft-Start Function

The S-8340/8341 Series has a built-in soft-start circuit. This circuit enables the output voltage ( $V_{OUT}$ ) to rise gradually over the specified soft-start time ( $t_{SS}$ ) to suppress the overshooting of the output voltage and the rush current from the power supply when the power is switched on or the ON/OFF pin is changed to "H". Generally, a rush current flows to an output capacitor through an inductor and a diode in the step-up circuit immediately after the power is turned on as shown in **Figure 9**. Note that the soft-start function of this IC, however, does not limit this current.

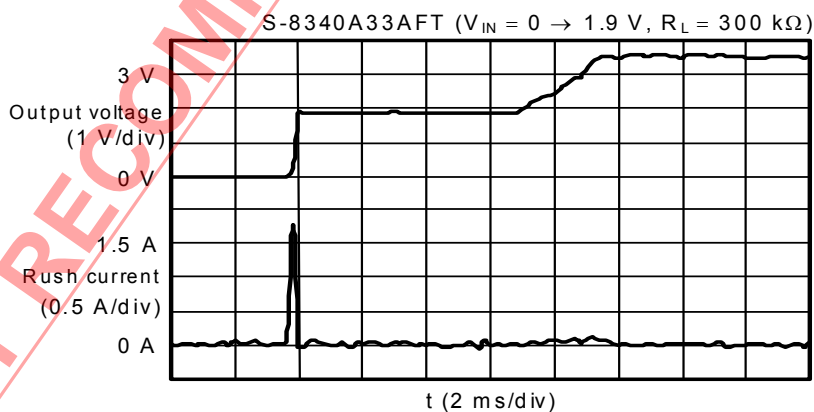

Figure 9 Waveforms of Output Voltage and Rush Current at Soft-Start

The soft-start circuit of the S-8340/8341 Series increases the duty ratio gradually as shown in **Figure 10**. The soft-start time ( $t_{SS}$ ) can be set with an external capacitor ( $C_{SS}$ ).



**Figure 10** Image of EXT Pin Waveform

If  $f_{OSC} = 600$  kHz and  $C_{SS} = 4700$  pF, the time until the duty ratio of 50% is reached is 9.7 ms (typ.).  
 If  $V_{IN} \geq 2$  V, the approximate time until a specific duty ratio is reached is calculated from the following formula :

$$\text{If } f_{OSC} = 600 \text{ kHz, } t_{SS} [\text{ms}] = C_{SS} [\text{pF}] \times \frac{8.336 \times \text{Duty} [\%] + 682.45}{535000}$$

$$\text{If } f_{OSC} = 300 \text{ kHz, } t_{SS} [\text{ms}] = C_{SS} [\text{pF}] \times \frac{6.564 \times \text{Duty} [\%] + 698}{229000}$$

Even if the IC reaches a certain duty at a duty ratio of 0 to 43%, there may be a delay of the output voltage ( $V_{OUT}$ ) in reaching the specified voltage ( $V_{OUT(S)}$ ). This delay occurs due to the delay of the error amplifier reference voltage in reaching the specified voltage (1.0 V). Note that the maximum delay time may be the value calculated when a duty ratio is 43%.

### 3. ON/OFF Pin (Shutdown Pin)

The ON/OFF pin stops or starts the step-up operation. When the ON/OFF pin is set to "L", all the internal circuits stop operating, reducing power consumption. The EXT pin voltage becomes equal to the  $V_{SS}$  voltage, thereby turning off the switching transistor. The ON/OFF pin is configured as shown in **Figure 11** and is not either pulled up or pulled down. So, do not use it in a floating state. Applying 0.3 to 0.8 V to the ON/OFF pin increases current consumption. So do not apply such voltage. When the ON/OFF pin is not used, connect it to the VDD pin. The ON/OFF pin does not have hysteresis.

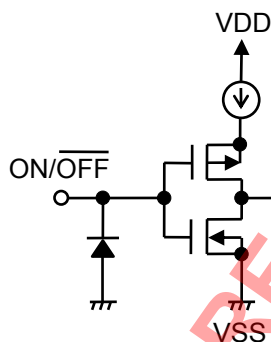

**Figure 11** ON/OFF Pin Structure

ON/OFF Pin	CR Oscillation Circuit	Output Voltage
"H"	Operating	Set value
"L"	Stopped	$\cong V_{IN}^{*1}$

\*1. Voltage obtained by extracting the voltage drop due to DC resistance of the inductor and the diode forward voltage from  $V_{IN}$ .

#### 4. Current Limit Circuit

The current limit circuit of the S-8340/8341 Series protects the external transistors from being damaged by heat due to an overload or magnetic saturation of coils. Inserting a SENSE resistor ( $R_{SENSE}$ ) between the external FET source or external NPN bipolar transistor emitter and  $V_{SS}$  and entering a connection point with a sensor resistor into the SENSE pin enables the current limit to function. Refer to “■ Standard Circuit”.

A current limiting comparator in the IC monitors the SENSE pin for reaching the current limit detection voltage ( $V_{SENSE} = 120 \text{ mV (typ.)}$ ). Upon detection of the voltage, the external transistor is held off for one clock of the oscillator so that the current flowing in the external transistor is limited. At the ON signal of the next clock, the external transistor is turned on and the current limit detection function is resumed.

However, this current limit circuit contains a CR filter with a time constant ( $\tau = 220 \text{ ns (typ.)}$ ) between the SENSE pin and the current limiting comparator in the IC to prevent detection errors caused by the spike voltage generated at the SENSE pin. If the time (pulse width  $t_{ON}$ : “H” level time at the EXT pin) after the external transistor turns on until the current limit circuit operates is short, the current value that is actually limited becomes higher than the current limit setting value determined by  $V_{SENSE}/R_{SENSE}$  as a side effect. The actual limit current value ( $I_{LIMIT}$ ) is expressed by the following equation :

$$I_{LIMIT} = \frac{V_{SENSE}}{R_{SENSE}} \div \left( 1 - e^{-\frac{t_{ON} \times 0.5}{CR}} \right)$$

**Remark** CR in the equation is determined by the internal CR filter and varies in the range 116 to 470 ns (220 ns (typ.).)

**Caution** Therefore, this current limit function does not guarantee full protection of external parts by  $I_{LIMIT} = V_{SENSE}/R_{SENSE}$  under all operating conditions. Perform a thorough evaluation using the actual devices.

For example, usage when the current value that the current limit circuit actually functions to raise the current limit set value decided by  $V_{SENSE}/R_{SENSE}$  that includes usage under the conditions that the input voltage become close to the output voltage or situations when the output voltage falls due to the activation of the current limit circuit and become close to the input voltage.

**Figure 12** shows an example of the actually measured increase of the peak current flowing through the coil when the current limit circuit functions while the input voltage is nearing the output voltage.

**Figure 13** shows an example of the actually measured increase of the peak current flowing through the coil when the output voltage drops and approaches the input voltage by increasing the output current after the current limit circuit functions.

**Input Voltage ( $V_{IN}$ ) vs. Coil Peak Current ( $I_{LPEAK}$ )**

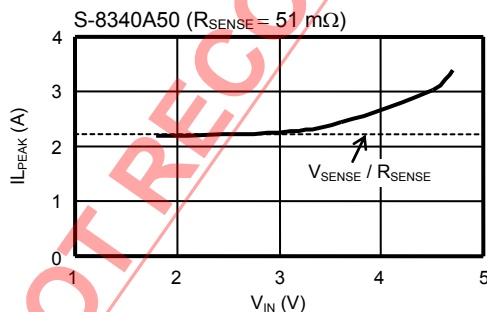

**Figure 12**  $I_{LPEAK}$  Measured at Activation of Current Limit ( $V_{OUT}$  Starts to Fall)

**Output Current ( $I_{OUT}$ ) vs. Coil Peak Current ( $I_{LPEAK}$ )**

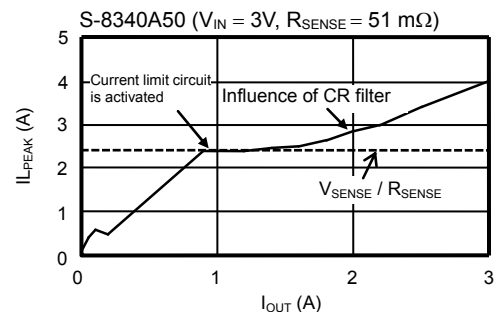

**Figure 13** Measuring Coil Peak Current ( $I_{LPEAK}$ )

If the current limit circuit is not used, remove  $R_{SENSE}$  and connect the external transistor source or the emitter and the SENSE pin to  $V_{SS}$ .

## ■ Series Products and External Parts Selection

### 1. Method for Selecting Series Products

The S-8340/8341 Series is classified into eight types, according to the control systems (PWM and PWM/PFM switching), oscillation frequencies, and output voltage setting types.

The following describes the features of respective types. Select the type according to the applications.

#### 1.1 Control Systems

Two different control systems are available : PWM control system (S-8340 Series) and PWM/PFM switching control system (S-8341 Series).

For applications for which the load current greatly differs between standby and operation, if the efficiency during standby is important, applying the PWM/PFM switching system (S-8341 Series) realizes high efficiency during standby.

For applications for which switching noise is critical, applying the PWM control system (S-8340 Series) whereby switching frequency does not change due to load current allows the ripple voltage to be easily eliminated by using a filter.

#### 1.2 Oscillation Frequencies

Either oscillation frequencies, 600 kHz (A and B types) or 300 kHz (C and D types), can be selected.

The A and B types whereby high operation frequency allows the L value to be reduced, so a small inductor can be used. In addition, use of small output capacitors is effective for downsizing devices.

The C and D types, whereby lower oscillation frequency realizes smaller self-consumption current, are highly efficient under light loads. In particular, the C type, when combined with a PWM/PFM switching control system, drastically improves the operation efficiency when the output load current is approximately 1 mA.

#### 1.3 Output Voltage Setting

Either fixed output type (A and C types) or external setting type (B and D types) can be selected.

The A and C types, whereby output voltage can be internally set between 2.5 and 6.0 V in the 0.1 V steps, realizes highly accurate output voltage of  $\pm 2.0\%$  with internal highly resistant and highly accurate resistors.

In the B and D types, the output voltage can be adjusted in the range 2.5 to 6.0 V by adding external resistors ( $R_{FB1}$  and  $R_{FB2}$ ) and a capacitor ( $C_{FB}$ ).

A temperature gradient can be provided by installing a thermistor in series to  $R_{FB1}$  and  $R_{FB2}$ .

The resistance of  $R_{FB1} + R_{FB2}$  must not exceed 2 M $\Omega$ , and set the ratio of  $R_{FB1}$  to  $R_{FB2}$  so that the FB pin is at 1.0 V. Add  $C_{FB}$  in parallel with  $R_{FB1}$  to prevent unstable operation due to output oscillation.

Set  $C_{FB}$  so that  $f_{OSC} = 1/(2 \times \pi \times C_{FB} \times R_{FB1})$  is 0.1 to 20 kHz (normally, 10 kHz).

Example :  $V_{OUT} = 3.0$  V,  $R_{FB1} = 200$  k $\Omega$ ,  $R_{FB2} = 100$  k $\Omega$ ,  $C_{FB} = 100$  pF

The accuracy of the output voltage  $V_{OUT}$  set with resistors  $R_{FB1}$  and  $R_{FB2}$  is affected by the absolute precision of external resistors  $R_{FB1}$  and  $R_{FB2}$ , the FB pin input current ( $I_{FB}$ ) and IC power supply voltage ( $V_{DD}$ ) as well as the precision of the voltage at FB pin (1 V  $\pm 2.0\%$ ).

When it is assumed that  $I_{FB}$  is 0 nA, the maximum absolute value variations of external resistors  $R_{FB1}$  and  $R_{FB2}$  are  $R_{FB1,max.}$  and  $R_{FB2,max.}$ , the minimum absolute value variations of external resistors  $R_{FB1}$  and  $R_{FB2}$  are  $R_{FB1,min.}$  and  $R_{FB2,min.}$ , and the shift of the output voltage due to the dependence of voltage on  $V_{DD}$  is  $\Delta V$ , the minimum value ( $V_{OUT min.}$ ) and maximum value ( $V_{OUT max.}$ ) of variations of  $V_{OUT}$  are expressed by the following formulas :

$$V_{OUT \text{ min.}} = \left(1 - \frac{R_{FB1 \text{ min.}}}{R_{FB2 \text{ max.}}}\right) \times 0.98 - \Delta V [V]$$

$$V_{OUT \text{ max.}} = \left(1 + \frac{R_{FB1 \text{ max.}}}{R_{FB2 \text{ min.}}}\right) \times 102 + \Delta V [V]$$

$R_{FB1}$  and  $R_{FB2}$  must be adjusted in order to set the voltage accuracy of  $V_{OUT}$  to the IC output voltage accuracy ( $V_{OUT} \pm 2.0\%$ ) or lower. The smaller  $R_{FB1}$  and  $R_{FB2}$  are, the less  $V_{OUT}$  is affected by the absolute value accuracy of  $R_{FB1}$  and  $R_{FB2}$ . The smaller  $R_{FB1}$  and  $R_{FB2}$  are, the less  $V_{OUT}$  is affected by  $I_{FB}$ .

To reduce the influence due to  $I_{FB}$  that affects variations of  $V_{OUT}$ , the  $R_{FB2}$  value must be set to a value sufficiently lower than the input impedance at the FB pin (1 V/50 nA = 20 MΩ (max.)).

Reactive current flows through  $R_{FB1}$  and  $R_{FB2}$ . Unless the reactive current value is limited as low as possible with respect to the actual load current, efficiency decreases. Therefore,  $R_{FB1}$  and  $R_{FB2}$  should be sufficiently large.

**Caution** If the  $R_{FB1}$  and  $R_{FB2}$  values are too large (1 MΩ or more),  $V_{OUT}$  is subject to be affected by external noise, therefore, thoroughly test the performance with the actual equipment.

Since the accuracy of  $V_{OUT}$  and reactive current must be traded off, they must be considered according to application requirements.

**Caution** Connect the VDD pin to the VOUT pin for both the fixed output types and external setting types as shown in “■ Standard Circuit”. In the cases when  $V_{DD}$  requires to be applied from  $V_{IN}$  or other power source instead of  $V_{OUT}$ , raise  $V_{DD}$  to 2.5 V or higher within the soft-start time (3.0 ms: A and B types, 6.0 ms: C and D types).

When the VDD pin is connected to the VOUT pin,  $V_{IN}$  can be increased slowly without any problems.

The table below provides a rough guide for selecting a product type according to the application requirements of the application.

Choose the product that gives you the largest number of circles (O).

**Table 9**

	S-8340				S-8341			
	A	B	C	D	A	B	C	D
The set output voltage is 6 V or less	☆		☆		☆		☆	
Set an output voltage freely		☆		☆		☆		☆
The efficiency under light loads (approx. 1mA) is an important factor					○	○	⊙	⊙
To be operated with a medium load current (200 mA class)	○	○	○	○	○	○	○	○
To be operated with a high load current (1 A class)	○	○	○	○	○	○	○	○
It is important to have a low-ripple voltage	○	○			○	○		
Downsizing of external components is important	⊙	⊙			⊙	⊙		

**Remark** The symbol "☆" denotes an indispensable condition, while the symbol "○" indicates that the corresponding series has superiority in that aspect. The symbol "⊙" indicates particularly high superiority.

## 2. Inductor

The inductance value (L value) greatly affects the maximum output current ( $I_{OUT}$ ) and the efficiency ( $\eta$ ). As the L value is reduced gradually, the peak current ( $I_{PK}$ ) increases and  $I_{OUT}$  increases. As the L value is made even smaller,  $I_{OUT}$  decreases since the efficiency degrades and the current driveability is insufficient. As the L value is increased, the dissipation in the switching transistor due to  $I_{PK}$  decreases, and the efficiency reaches the maximum at a certain L value. As the L value is made even larger, the efficiency degrades since the dissipation due to the series resistance of the inductor increases.  $I_{OUT}$  also decreases. In the S-8340/8341 Series, as the L value is increased, the output voltage may be unstable depending on the conditions of the input voltage, output voltage, and load current. Select the L value after performing a thorough valuation under actual use conditions. The guidelines for the L range are from 2.2 to 22  $\mu\text{H}$  for the A and B types, and 4.7 to 47  $\mu\text{H}$  for the C and D types. The recommended L value is 5 to 10  $\mu\text{H}$  for the A and B types, and 10 to 22  $\mu\text{H}$  for the C and D types. When choosing an inductor, attention to its allowable current should be paid since the current exceeding the allowable value will cause magnetic saturation in the inductor, leading to a marked decline in efficiency and a breakdown of the IC due to large current. An inductor should therefore be selected so that  $I_{PK}$  does not surpass its allowable current.  $I_{PK}$  is represented by the following equations in non-continuous operation mode.

$$I_{PK} = \sqrt{\frac{2 \times I_{OUT} \times (V_{OUT} + V_F - V_{IN})}{f_{OSC} \times L}}$$

Where  $f_{OSC}$  is the oscillation frequency, L is the inductance value of the inductor, and  $V_F$  is the forward voltage of the diode.  $V_F$  should be appropriately 0.4 V. For example, if a power supply with the input voltage ( $V_{IN}$ ) = 3 V, output voltage ( $V_{OUT}$ ) = 5 V, and load current ( $I_{OUT}$ ) = 30 mA is used,  $f_{OSC}$  = 600 kHz when the S-8340A50AFT is used. When 10  $\mu\text{H}$  is selected for the L value,  $I_{PK}$  = 155 mA from the above formula. Therefore, in this case, an inductor with a permissible current of 155 mA or higher for the L value of 10  $\mu\text{H}$  should be selected.

## 3. Diode

Use an external diode that meets the following requirements :

- Low forward voltage (Schottky barrier diode is recommended.)
- High switching speed (50 ns max.)
- The reverse-direction withstand voltage is  $V_{OUT} + V_F$  or higher.
- The current rating is  $I_{PK}$  or larger.

## 4. Capacitors ( $C_{IN}$ , $C_L$ )

A capacitor inserted on the input side ( $C_{IN}$ ) improves the efficiency by reducing the power impedance and stabilizing the input current. Select a  $C_{IN}$  value according to the impedance of the power supply used. Approximately 47 to 100  $\mu\text{F}$  is recommended for a capacitance depending on the impedance of the power source and load current value. For the output side capacitor ( $C_L$ ), select a large capacitance with low ESR (Equivalent Series Resistance) for smoothing the ripple voltage. When the input voltage is extremely high or the load current is extremely large, the output voltage may become unstable. In this case the unstable area will become narrow by selecting a large capacitance for an output capacitor. A tantalum electrolyte capacitor is recommended since the unstable area widens when a capacitor with a large ESR, such as an aluminum electrolyte capacitor, or a capacitor with a small ESR, such as a ceramic capacitor, is chosen.

It is recommended that a capacitor of which the capacitance is 47 to 200  $\mu\text{F}$  and ESR is 40 to 270  $\text{m}\Omega$  be selected. Fully evaluate input and output capacitors under actual operating conditions, then select them.



## 5. External Transistors

Enhancement (N-channel) MOS FET type or bipolar (NPN) type can be used for the external transistors.

### 5.1 Enhancement (N-Channel) MOS FET Type

The EXT pin can directly drive an N-channel MOS FET. When an N-channel MOS FET is used, efficiency will be 2 to 3% higher than that achieved by an NPN bipolar transistor since the MOS FET switching speed is faster and power dissipation due to the base current is avoided.

A large current may flow at power on with some MOS FETs selected. Perform thorough evaluation using the actual devices to select. The recommended gate capacitance of the MOS FET to be used is 1200 pF or smaller.

The important parameters in selecting a MOS FET are threshold voltage, breakdown voltage between drain and source, total gate capacitance, on-resistance, and the current rating.

The EXT pin voltage swings between  $V_{DD}$  and  $V_{SS}$ . If  $V_{DD}$  is low, a MOS FET of which the threshold voltage is low enough so that the MOS FET is completely turned on must be used. If  $V_{DD}$  is high, the breakdown voltage between the gate and source must be higher by at least several volts.

During the step-up operation, voltage  $V_{OUT} + V_F$  is applied between the drain and source of the MOS FET. So the breakdown voltage between the drain and source should be higher than the  $V_{OUT} + V_F$  voltage by at least several volts.

The total gate capacitance and the on-resistance affect the efficiency.

The larger the total gate capacitance becomes and the higher the input voltage becomes, the more the power dissipation for charging and discharging the gate capacitance by switching operation increases, and affects the efficiency at low load current region. If the efficiency at low load is important, select MOS FETs with a small total gate capacitance.

In the regions where the load current is high, the efficiency is affected by power dissipation caused by the resistance of the MOS FETs. If the efficiency under heavy load is particularly important in the application, choose MOS FETs which have an on-resistance as low as possible. As for the current rating, select a MOS FET whose maximum continuous drain current rating is higher than  $I_{PK}$ .

### 5.2 Bipolar (NPN) Type

Figures 16 and 17 in "■ Standard Circuits (2) Using Bipolar Transistors" show sample circuit diagrams using Sanyo Electric Co., Ltd. 2SD1628G for the bipolar transistor (NPN). The driveability for increasing the output current by means of a bipolar transistor depend on the  $h_{FE}$  and  $R_b$  values of that bipolar transistor.

The  $R_b$  value is given by the following equation :

$$R_b = \frac{V_{DD} - 0.7}{I_b} - \frac{0.4}{|I_{EXTH}|}$$

Find the necessary base current ( $I_b$ ) using the  $h_{FE}$  value of the bipolar transistor by the equation,  $I_b = I_{PK}/h_{FE}$ , and select a smaller  $R_b$  value.

A small  $R_b$  value can increase the output current, but the efficiency decreases. A current may flow as the pulses or voltage drops take place due to the wiring resistance or some other reason. Determine an optimum value through experimentation.

In addition, if a speed-up capacitor ( $C_b$ ) is inserted in parallel with the resistance ( $R_b$ ) as shown in Figures 16 and 17, the switching loss will be reduced, leading to a higher efficiency.

Select a  $C_b$  value by using the following equation as a guide :

$$C_b \leq \frac{1}{2\pi \times R_b \times f_{osc} \times 0.1}$$

However, the optimum  $C_b$  value differs depending upon the characteristics of the bipolar transistor. Select a  $C_b$  value after performing a thorough evaluation.

■ Standard Circuit

(1) Using MOS FET

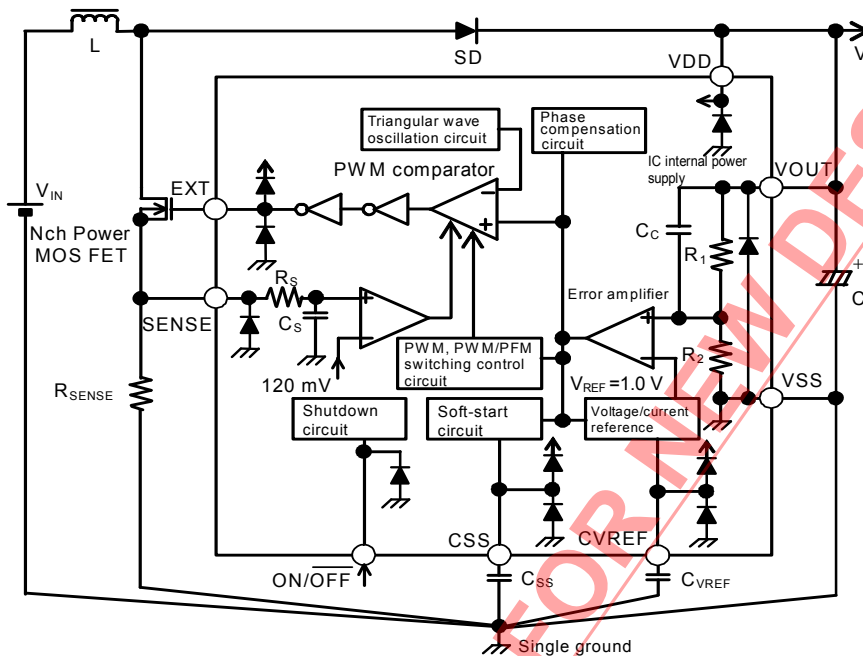

Figure 14 Output Voltage Fixed Output Type

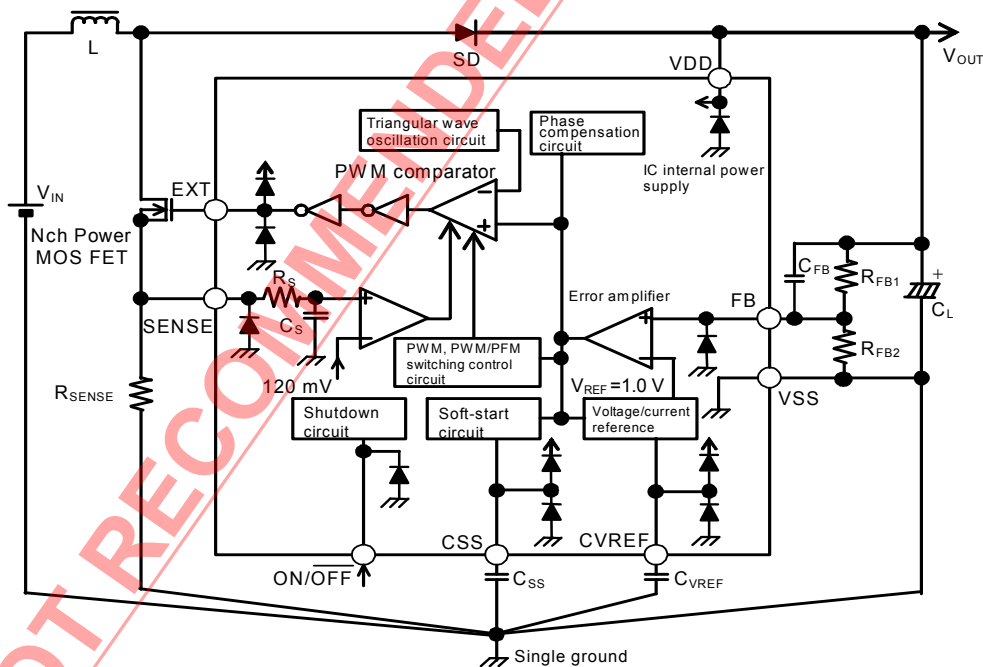

Figure 15 Output Voltage External Setting Type



(2) Using Bipolar Transistor

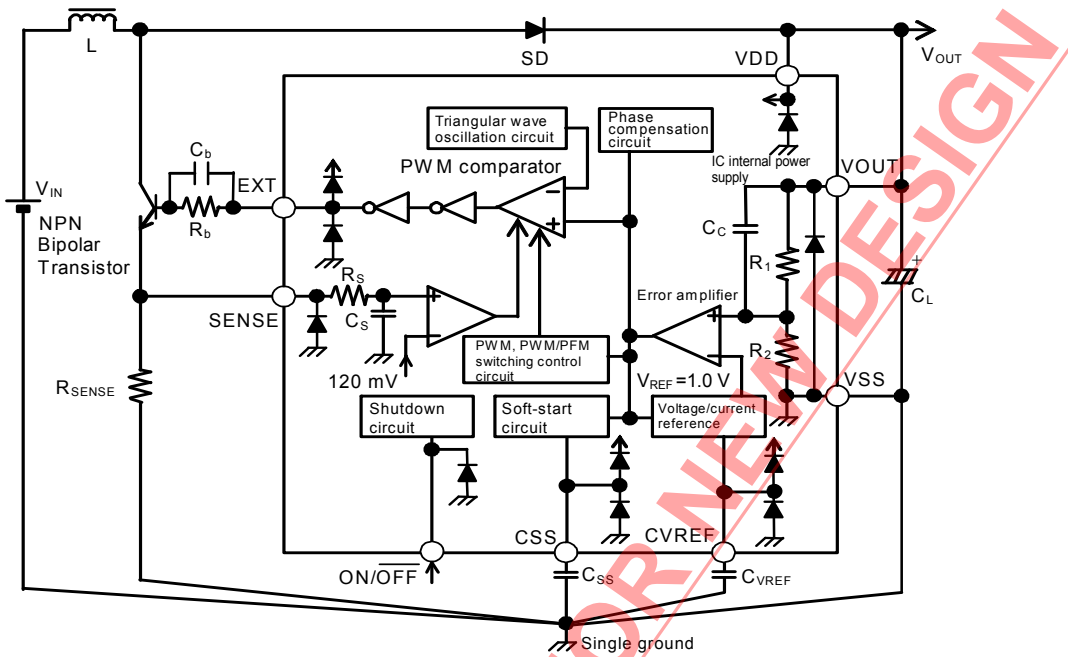

Figure 16 Output Voltage Fixed Output Type

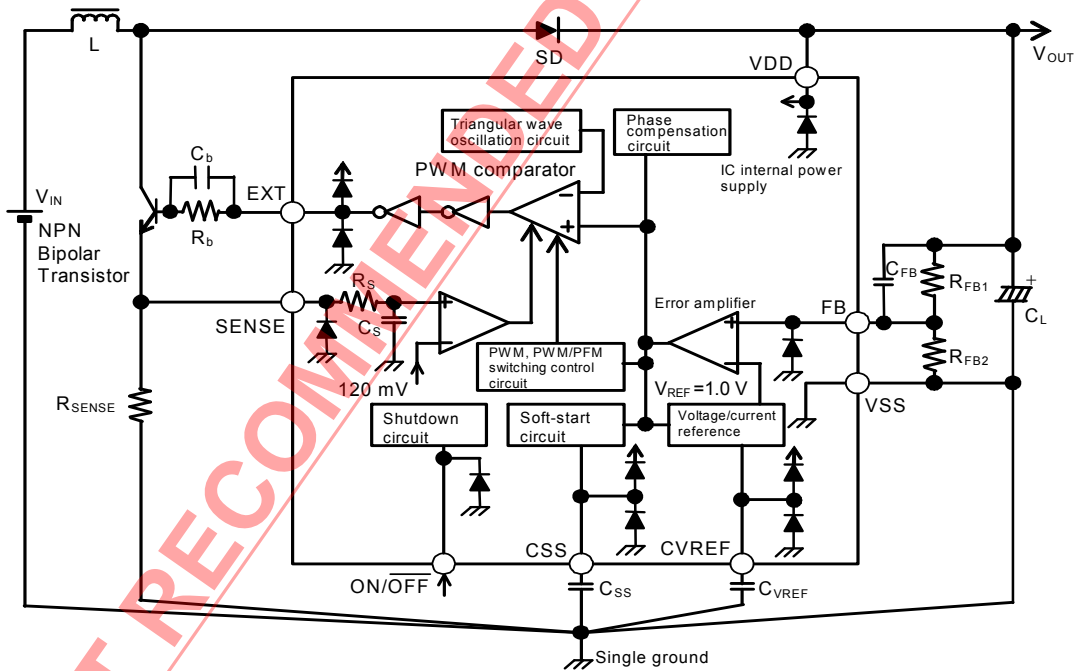

Figure 17 Output Voltage External Setting Type

**Caution** The above connection and constant will not guarantee successful operation. Perform thorough evaluation using the actual application to set the constant.

## ■ Precautions

- Mount the external capacitors, diode, coil, and other peripheral parts as close to the IC as possible, and make a one-point grounding.
- Characteristic ripple voltage and spike noise occur in IC containing switching regulators. Moreover rush current flows at the time of a power supply injection. Because these largely depend on the coil, the capacitor and impedance of power supply used, fully check them using an actually mounted model.
- Make sure that dissipation of the switching transistor especially at high temperature will not surpass the power dissipation of the package.
- To stabilize operation, use a capacitor with a low ESR as a bypass capacitor between the VDD and VSS pins of the IC, and install and wire it with a short distance and a low impedance. Connect  $C_{VREF}$  to the VSS pin.
- The main circuit of the IC operates on the internal power supply connected to the CVREF pin.  $C_{VREF}$  is a bypass capacitor that stabilizes the internal power supply. Use a 0.01 to 1  $\mu$ F ceramic capacitor as  $C_{VREF}$  and install and wire it to assure a short distance and a low impedance.
- Switching regulator performance varies depending on the design of PC patterns, peripheral circuits and parts. Thoroughly evaluate the actual device when setting. When using parts other than those which are recommended, contact the ABLIC Inc. marketing department.
- Do not apply an electrostatic discharge to this IC that exceeds the performance ratings of the built-in electrostatic protection circuit.
- ABLIC Inc. claims no responsibility for any disputes arising out of or in connection with any infringement by products including this IC of patents owned by a third party.

NOT RECOMMENDED FOR NEW DESIGN

■ Characteristics

1. Examples of Major Characteristics (Typical Data)

(1) Current Consumption 1 ( $I_{SS1}$ ) vs. Supply Voltage ( $V_{DD}$ )

S-8340A33A ( $f_{OSC}$ : 600 kHz)

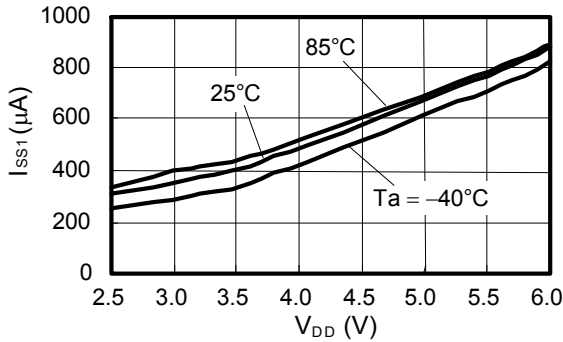

S-8340C33A ( $f_{OSC}$ : 300 kHz)

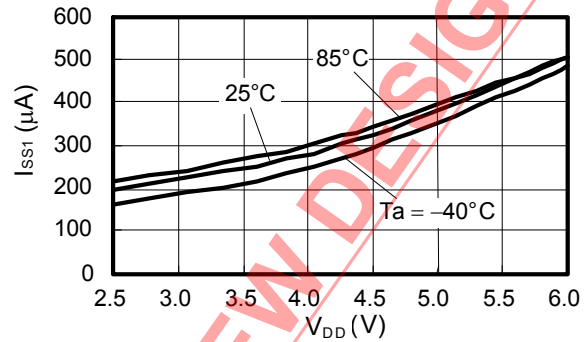

(2) Current Consumption 2 ( $I_{SS2}$ ) vs. Supply Voltage ( $V_{DD}$ )

S-8340A33A ( $f_{OSC}$ : 600 kHz)

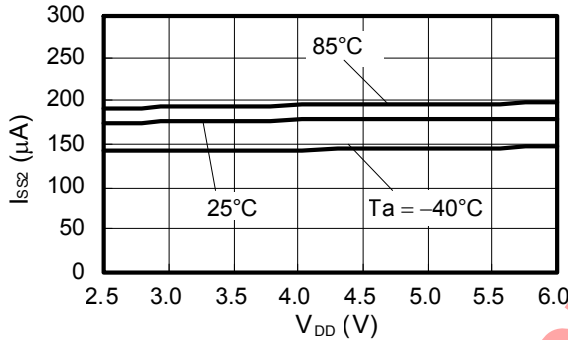

S-8340C33A ( $f_{OSC}$ : 300 kHz)

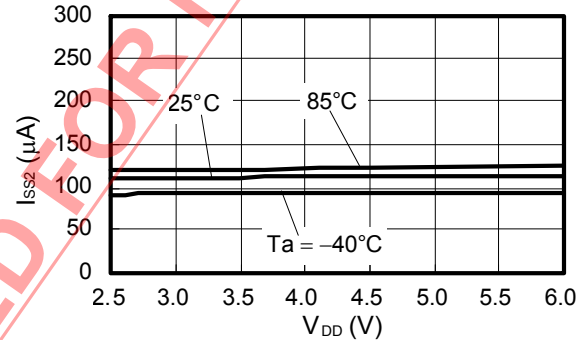

(3) Current Consumption at Shutdown ( $I_{SSS}$ ) vs. Supply Voltage ( $V_{DD}$ )

S-8340A33A ( $f_{OSC}$ : 600 kHz) / S-8340C33A ( $f_{OSC}$ : 300 kHz)

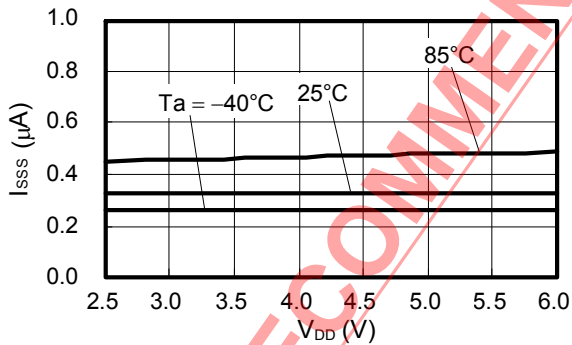

(4) Oscillation Frequency ( $f_{OSC}$ ) vs. Supply Voltage ( $V_{DD}$ )

S-8340A33A ( $f_{OSC}$ : 600 kHz)

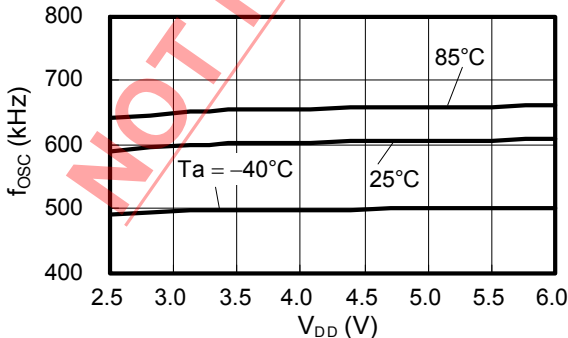

S-8340C33A ( $f_{OSC}$ : 300 kHz)

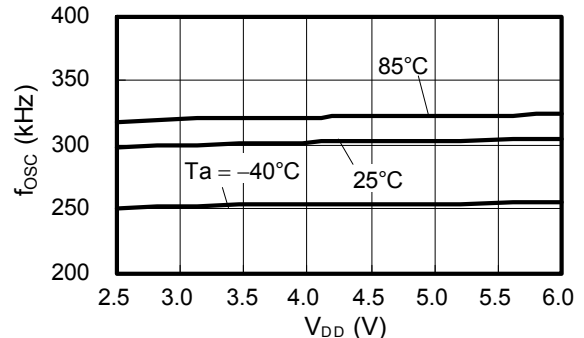

(5) EXT Pin Output Current "H" ( $I_{EXTH}$ ) vs. Supply Voltage ( $V_{DD}$ )

S-8340A33A ( $f_{OSC}$  : 600 kHz) / S-8340C33A ( $f_{OSC}$  : 300 kHz)

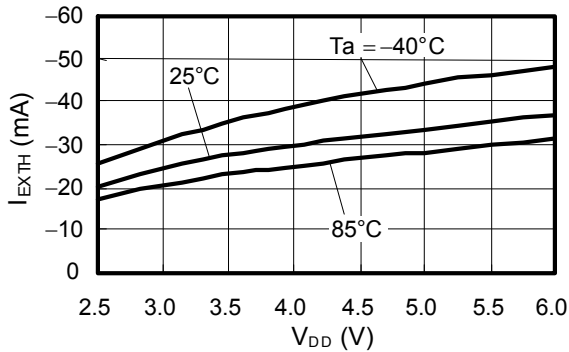

(6) EXT Pin Output Current "L" ( $I_{EXTL}$ ) vs. Supply Voltage ( $V_{DD}$ )

S-8340A33A ( $f_{OSC}$  : 600 kHz) / S-8340C33A ( $f_{OSC}$  : 300 kHz)

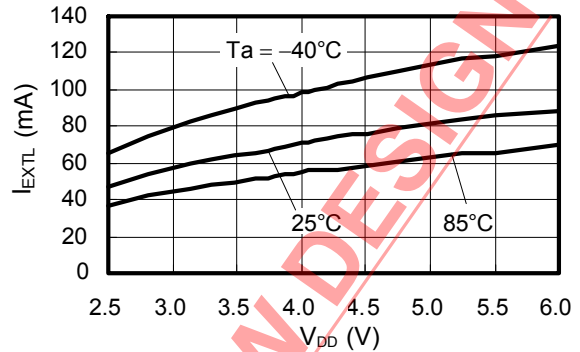

(7) Soft-Start Time ( $t_{SS}$ ) vs. Supply Voltage ( $V_{DD}$ )

S-8340A33A ( $f_{OSC}$  : 600 kHz)

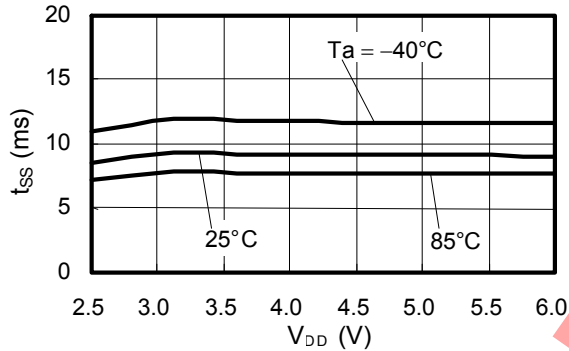

S-8340C33A ( $f_{OSC}$  : 300 kHz)

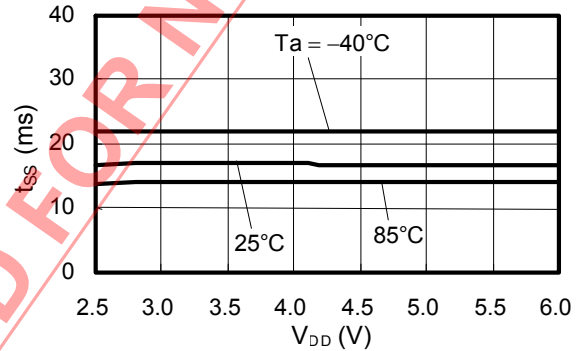

(8) ON/OFF Pin Input Voltage "H" ( $V_{SH}$ ) vs. Supply Voltage ( $V_{DD}$ )

S-8340A33A ( $f_{OSC}$  : 600 kHz) / S-8340C33A ( $f_{OSC}$  : 300 kHz)

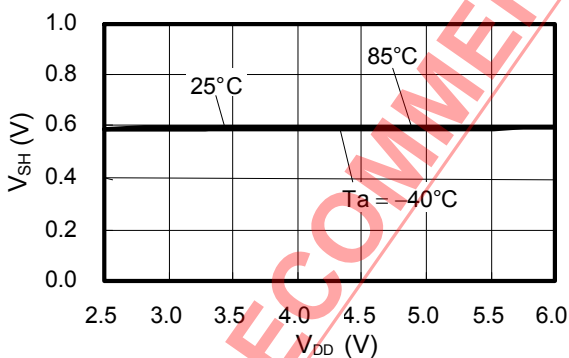

(9) ON/OFF Pin Input Voltage "L" ( $V_{SL}$ ) vs. Supply Voltage ( $V_{DD}$ )

S-8340A33A ( $f_{OSC}$  : 600 kHz) / S-8340C33A ( $f_{OSC}$  : 300 kHz)

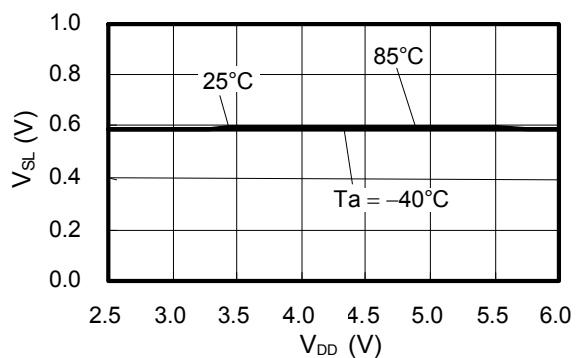

(10) Output Voltage ( $V_{OUT}$ ) vs. Supply Voltage ( $V_{DD}$ )

S-8340A25A ( $f_{OSC}$  : 600 kHz) / S-8340C25A ( $f_{OSC}$  : 300 kHz)

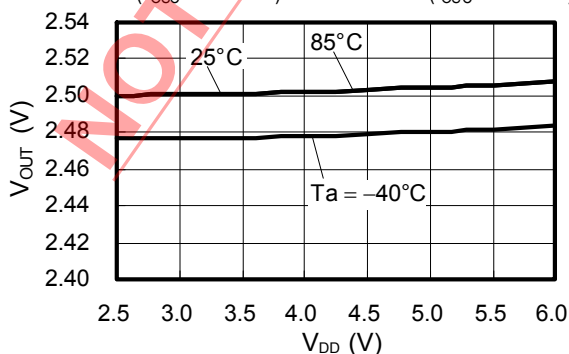

S-8340A33A ( $f_{OSC}$  : 600 kHz) / S-8340C33A ( $f_{OSC}$  : 300 kHz)

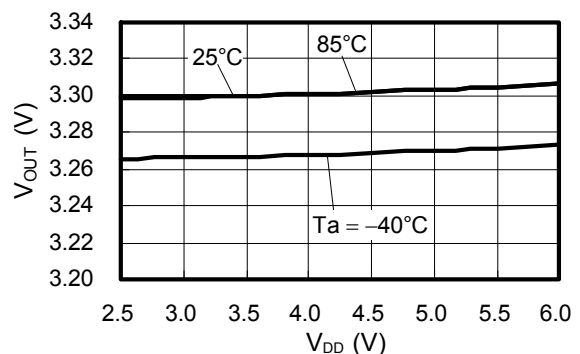

S-8340A50A ( $f_{osc} : 600 \text{ kHz}$ ) / S-8340C50A ( $f_{osc} : 300 \text{ kHz}$ )

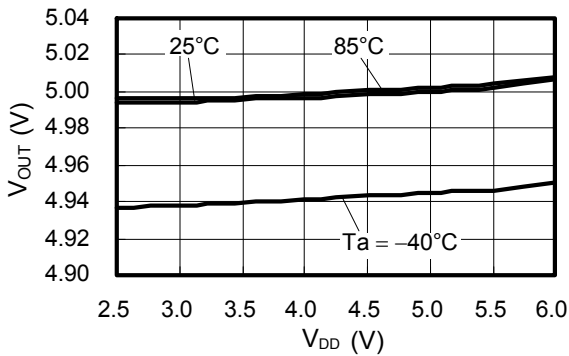

(11) Oscillation Start Voltage ( $V_{ST}$ ) vs. Temperature ( $T_a$ ) (12) Maximum Duty Ratio (MaxDuty) vs. Supply Voltage ( $V_{DD}$ )

S-8340A33A ( $f_{osc} : 600 \text{ kHz}$ ) / S-8340C33A ( $f_{osc} : 300 \text{ kHz}$ )

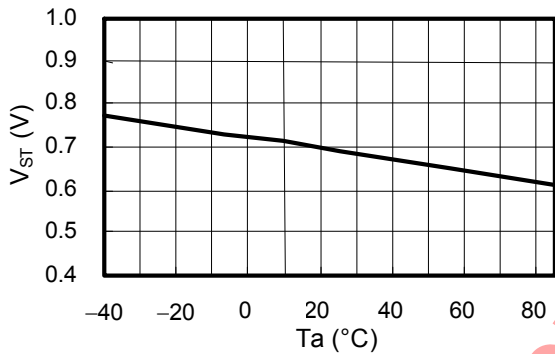

S-8340A33A ( $f_{osc} : 600 \text{ kHz}$ ) / S-8340C33A ( $f_{osc} : 300 \text{ kHz}$ )

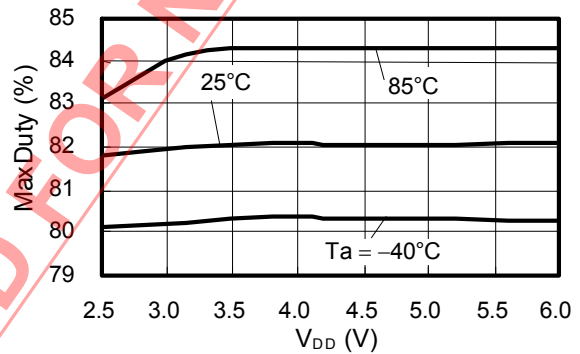

(13) PWM/PFM Switching Duty Ratio (PFMDuty) vs. Supply Voltage ( $V_{DD}$ )

S-8341A33A ( $f_{osc} : 600 \text{ kHz}$ )

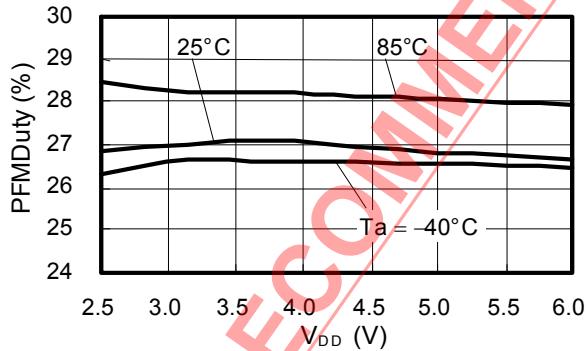

S-8341C33A ( $f_{osc} : 300 \text{ kHz}$ )

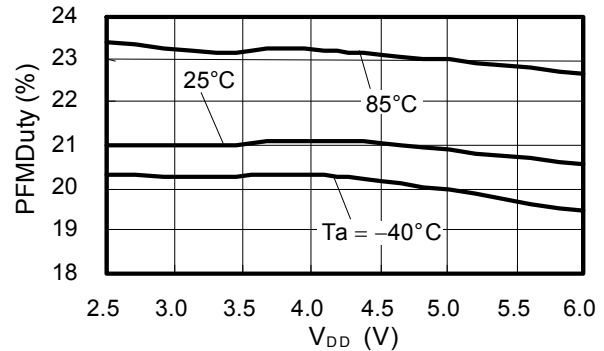

(14) Current Limit Detection Ratio ( $V_{SENSE}$ ) vs. Supply Voltage ( $V_{DD}$ )

S-8340A33A ( $f_{osc} : 600 \text{ kHz}$ ) / S-8340C33A ( $f_{osc} : 300 \text{ kHz}$ )

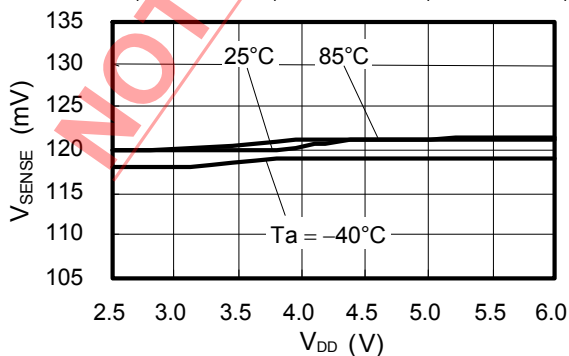

**2. Examples of Transient Response Characteristics**

**(1) Power-on (Typical Data)**

**S-8340A33AFT**,  $f_{osc} = 600 \text{ kHz}$ ,  $T_a = 25^\circ\text{C}$

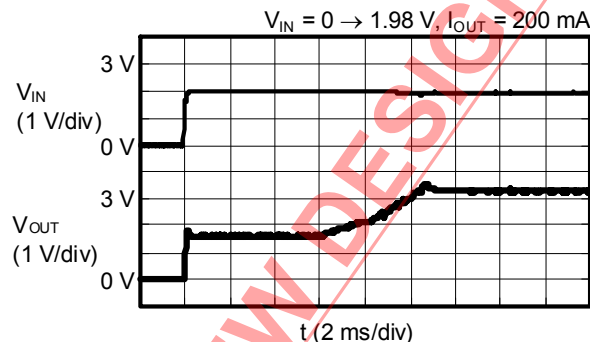
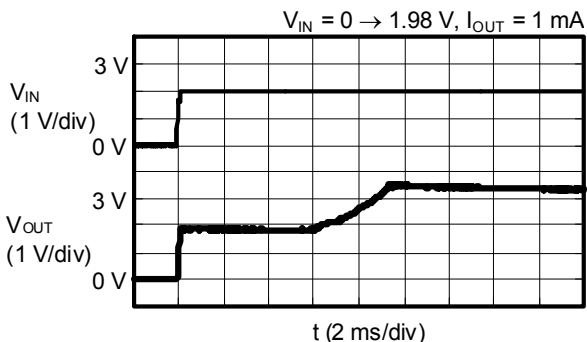

**S-8340C33AFT**,  $f_{osc} = 300 \text{ kHz}$ ,  $T_a = 25^\circ\text{C}$

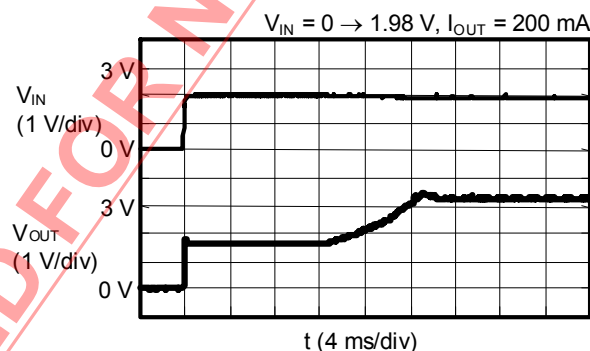
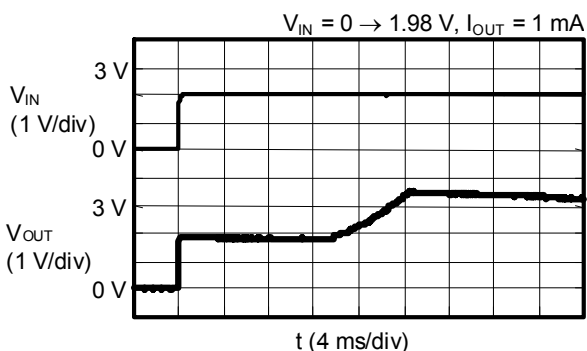

**(2) ON/OFF Pin Response (Typical Data)**

**S-8340A33AFT**,  $f_{osc} = 600 \text{ kHz}$ ,  $T_a = 25^\circ\text{C}$

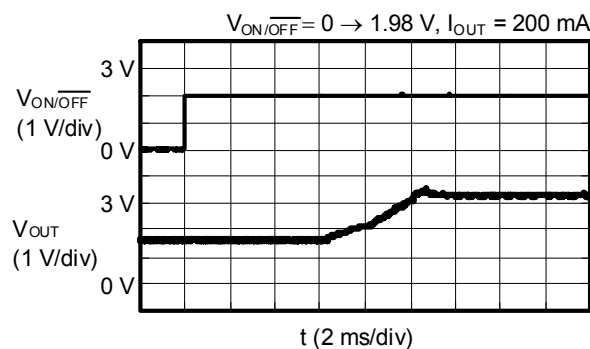
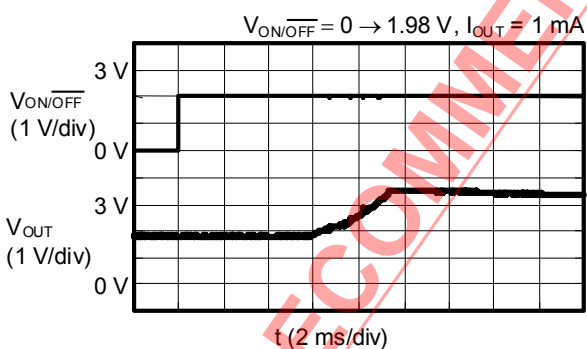

**S-8340C33AFT**,  $f_{osc} = 300 \text{ kHz}$ ,  $T_a = 25^\circ\text{C}$

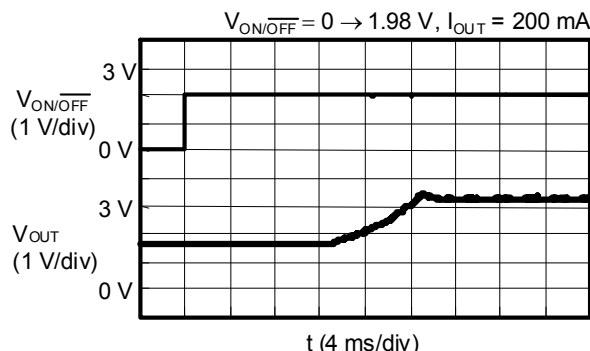
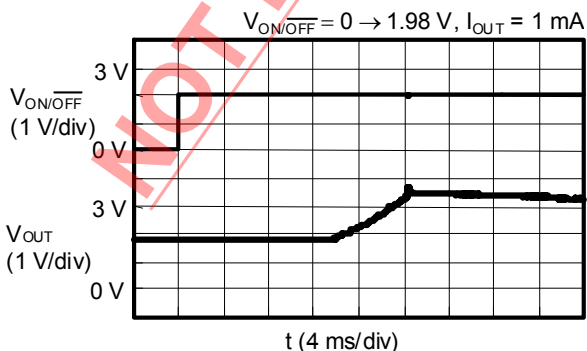

**(3) Load Fluctuations**

**S-8340A33AFT,  $f_{OSC} = 600$  kHz**

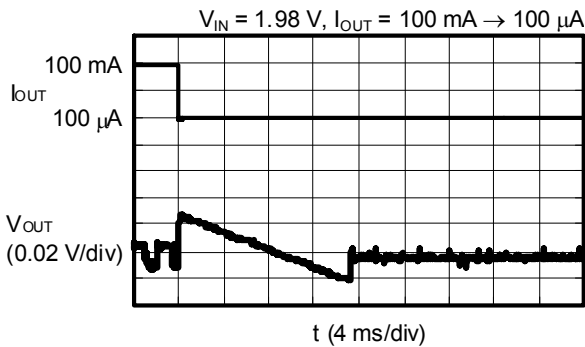

**S-8340C33AFT,  $f_{OSC} = 300$  kHz**

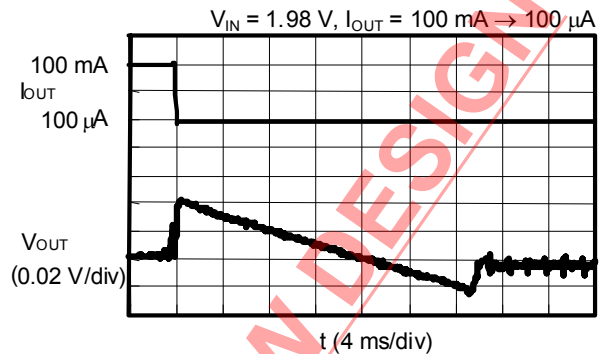

**S-8340A33AFT,  $f_{OSC} = 600$  kHz**

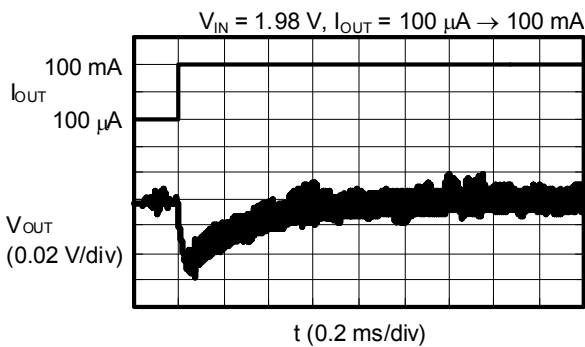

**S-8340C33AFT,  $f_{OSC} = 300$  kHz**

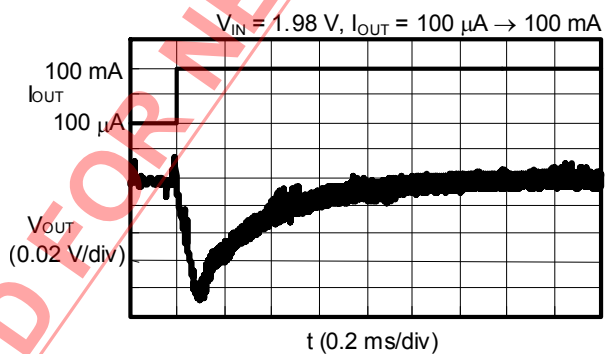

**(4) Input Voltage Fluctuations**

**S-8340A33AFT,  $f_{OSC} = 600$  kHz**

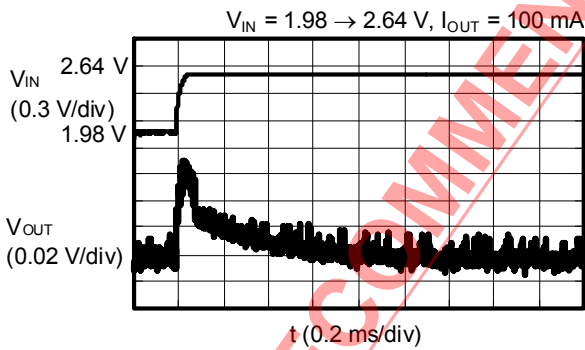

**S-8340C33AFT,  $f_{OSC} = 300$  kHz**

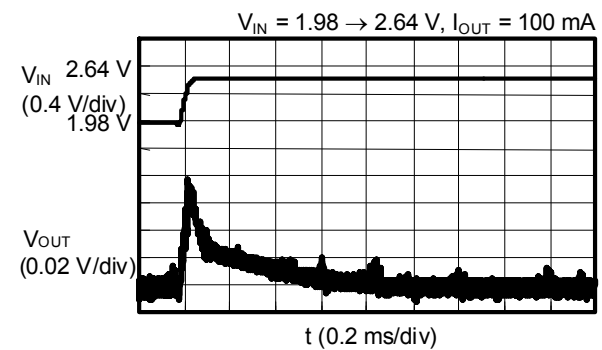

**S-8340A33AFT,  $f_{OSC} = 600$  kHz**

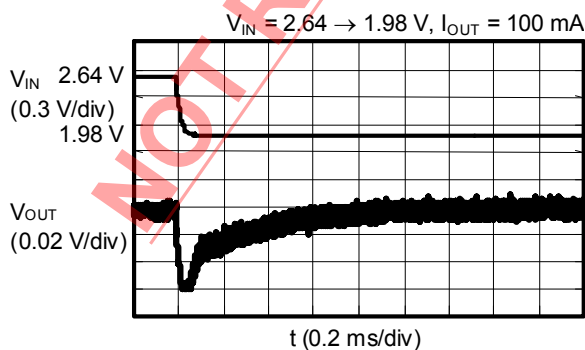

**S-8340C33AFT,  $f_{OSC} = 300$  kHz**

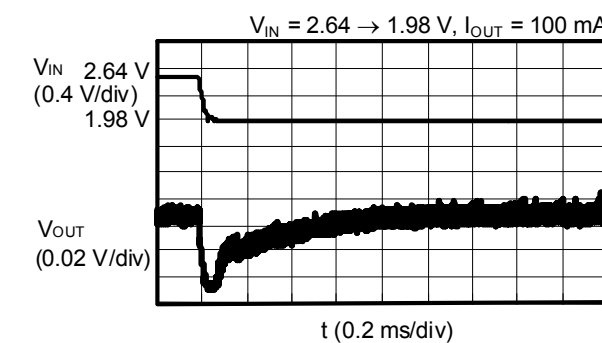

■ Reference Data

Reference data are intended for use in selecting external parts to the IC. The information therefore provides characteristic data in which external parts are selected with a view of wide variety of IC applications. All data shows typical value.

1. External Parts for Reference Data

**Table 10 External Parts List for Output Current vs. Efficiency, Output Current vs. Output Voltage Characteristics Data for A Type**

No.	Product Name	Output Voltage	Inductor	Transistor	Diode	Output Capacitor	Sense Resistor	Application
(1)	S-8340A25AFT	2.5 V	CDRH5D18/4.1 μH	NDS335N	RB491D	F920J476MB3 × 1	0 Ω	*1
(2)			CDRH124/10 μH	FTS2001	RBO81L-20	F951C476MG1 × 2		*2
(3)	S-8341A25AFT	2.5 V	CDRH5D18/4.1 μH	NDS335N	RB491D	F920J476MB3 × 1		*1
(4)			CDRH124/10 μH	FTS2001	RBO81L-20	F951C476MG1 × 2		*2
(5)	S-8340A33AFT	3.3 V	CDRH5D18/4.1 μH	NDS335N	RB491D	F920J476MB3 × 1	0 Ω	*1
(6)			CDRH124/10 μH	FTS2001	RBO81L-20	F951C476MG1 × 2		*2
(7)	S-8341A33AFT	3.3 V	CDRH5D18/4.1 μH	NDS335N	RB491D	F920J476MB3 × 1		*1
(8)			CDRH124/10 μH	FTS2001	RBO81L-20	F951C476MG1 × 2		*2
(9)	S-8340A50AFT	5.0 V	CDRH5D18/4.1 μH	NDS335N	RB491D	F951A476MF1 × 1	0 Ω	*1
(10)			CDRH124/10 μH	FTS2001	RBO81L-20	F951C476MG1 × 2		*2
(11)	S-8341A50AFT	5.0 V	CDRH5D18/4.1 μH	NDS335N	RB491D	F951A476MF1 × 1		*1
(12)			CDRH124/10 μH	FTS2001	RBO81L-20	F951C476MG1 × 2		*2

- \*1. CDRH5D18 + NDS335N + RB491D: For small and thin parts of which height is 2 mm or shorter (The maximum current of an external part should be set to 1.7 A.)
- \*2. CDRH124 + FTS2001 + RBO81L-20: For heavy load current (The maximum current of an external part should be set to 4.5 A.)

**Table 11 External Parts List for Output Current vs. Efficiency, Output Current vs. Output Voltage Characteristics Data for C Type**

No.	Product Name	Output Voltage	Inductor	Transistor	Diode	Output Capacitor	Sense Resistor	Application
(13)	S-8340C25AFT	2.5 V	CDRH6D28/10 μH	FDN335N	RB491D	F951C476MG1 × 1	0 Ω	*3
(14)			CDRH124/10 μH	FTS2001	RBO81L-20	F951C476MG1 × 2		*4
(15)	S-8341C25AFT	2.5 V	CDRH6D28/10 μH	FDN335N	RB491D	F951C476MG1 × 1		*3
(16)			CDRH124/10 μH	FTS2001	RBO81L-20	F951C476MG1 × 2		*4
(17)	S-8340C33AFT	3.3 V	CDRH6D28/10 μH	FDN335N	RB491D	F951C476MG1 × 1	0 Ω	*3
(18)			CDRH124/10 μH	FTS2001	RBO81L-20	F951C476MG1 × 2		*4
(19)	S-8341C33AFT	3.3 V	CDRH6D28/10 μH	FDN335N	RB491D	F951C476MG1 × 1		*3
(20)			CDRH124/10 μH	FTS2001	RBO81L-20	F951C476MG1 × 2		*4
(21)	S-8340C50AFT	5.0 V	CDRH6D28/10 μH	FDN335N	RB491D	F951C476MG1 × 1	0 Ω	*3
(22)			CDRH124/10 μH	FTS2001	RBO81L-20	F951C476MG1 × 2		*4
(23)	S-8341C50AFT	5.0 V	CDRH6D28/10 μH	FDN335N	RB491D	F951C476MG1 × 1		*3
(24)			CDRH124/10 μH	FTS2001	RBO81L-20	F951C476MG1 × 2		*4

- \*3. CDRH6D28 + FDN335N + RB491D: For part height of 3 mm and high efficiency
- \*4. CDRH124 + FTS2001 + RBO81L-20: For optimizing the load current driveability



**Table 12 External Parts List for Output Current vs. PFM/PWM Switching Input Voltage Characteristics Data for A Type**

No.	Product Name	Output Voltage	Inductor	Transistor	Diode	Output Capacitor	Sense Resistor	Application
(25)	S-8341A25AFT	2.5 V	CDRH5D18/4.1 $\mu$ H	NDS335N	RB491D	F920J476MB3 $\times$ 1	0 $\Omega$	*1
(26)			CDRH124/10 $\mu$ H	FTS2001	RBO81L-20	F951C476MG1 $\times$ 2		*2
(27)	S-8341A33AFT	3.3 V	CDRH5D18/4.1 $\mu$ H	NDS335N	RB491D	F920J476MB3 $\times$ 1		*1
(28)			CDRH124/10 $\mu$ H	FTS2001	RBO81L-20	F951C476MG1 $\times$ 2		*2
(29)	S-8341A50AFT	5.0 V	CDRH5D18/4.1 $\mu$ H	NDS335N	RB491D	F951A476MF1 $\times$ 1		*1
(30)			CDRH124/10 $\mu$ H	FTS2001	RBO81L-20	F951C476MG1 $\times$ 2		*2

- \*1. CDRH5D18 + NDS335N + RB491D: For small and thin parts of which height is 2 mm or shorter (The maximum current of an external part should be set to 1.7 A.)  
 \*2. CDRH124 + FTS2001 + RBO81L-20: For heavy load current (The maximum current of an external part should be set to 4.5 A.)

**Table 13 External Parts List for Output Current vs. PFM/PWM Switching Input Voltage Characteristics Data for C Type**

No.	Product Name	Output Voltage	Inductor	Transistor	Diode	Output Capacitor	Sense Resistor	Application
(31)	S-8341C25AFT	2.5 V	CDRH6D28/10 $\mu$ H	FDN335N	RB491D	F951C476MG1 $\times$ 1	0 $\Omega$	*3
(32)			CDRH124/10 $\mu$ H	FTS2001	RBO81L-20	F951C476MG1 $\times$ 2		*4
(33)	S-8341C33AFT	3.3 V	CDRH6D28/10 $\mu$ H	FDN335N	RB491D	F951C476MG1 $\times$ 1		*3
(34)			CDRH124/10 $\mu$ H	FTS2001	RBO81L-20	F951C476MG1 $\times$ 2		*4
(35)	S-8341C50AFT	5.0 V	CDRH6D28/10 $\mu$ H	FDN335N	RB491D	F951C476MG1 $\times$ 1		*3
(36)			CDRH124/10 $\mu$ H	FTS2001	RBO81L-20	F951C476MG1 $\times$ 2		*4

- \*3. CDRH6D28 + FDN335N + RB491D: For part heights of 3 mm and high efficiency  
 \*4. CDRH124 + FTS2001 + RBO81L-20: For optimizing the load current driveability

NOT RECOMMENDED FOR NEW DESIGN

External Parts List for Ripple Data

**Table 14 External Parts for Output Current vs. Ripple Voltage Characteristics Data for A Type**

No.	Product Name	Output Voltage	Inductor	Transistor	Diode	Output Capacitor	Sense Resistor	Application	
(37)	S-8340A25AFT	2.5 V	CDRH5D18/4.1 $\mu$ H	NDS335N	RB491D	F920J476MB3 $\times$ 1 F920J476MB3 $\times$ 2	0 $\Omega$	*1	
(38)			CDRH124/10 $\mu$ H	FTS2001	RBO81L-20	F951C476MG1 $\times$ 2 F951A107MG1 $\times$ 2		*2	
(39)	S-8341A25AFT		CDRH5D18/4.1 $\mu$ H	NDS335N	RB491D	F920J476MB3 $\times$ 1 F920J476MB3 $\times$ 2		*1	
(40)			CDRH124/10 $\mu$ H	FTS2001	RBO81L-20	F951C476MG1 $\times$ 2 F951A107MG1 $\times$ 2		*2	
(41)	S-8340A33AFT	3.3 V	CDRH5D18/4.1 $\mu$ H	NDS335N	RB491D	F920J476MB3 $\times$ 1 F920J476MB3 $\times$ 2		0 $\Omega$	*1
(42)			CDRH124/10 $\mu$ H	FTS2001	RBO81L-20	F951C476MG1 $\times$ 2 F951A107MG1 $\times$ 2			*2
(43)	S-8341A33AFT		CDRH5D18/4.1 $\mu$ H	NDS335N	RB491D	F920J476MB3 $\times$ 1 F920J476MB3 $\times$ 2			*1
(44)			CDRH124/10 $\mu$ H	FTS2001	RBO81L-20	F951C476MG1 $\times$ 2 F951A107MG1 $\times$ 2			*2
(45)	S-8340A50AFT	5.0 V	CDRH5D18/4.1 $\mu$ H	NDS335N	RB491D	F951A476MF1 $\times$ 1 F951A476MF1 $\times$ 2	0 $\Omega$		*1
(46)			CDRH124/10 $\mu$ H	FTS2001	RBO81L-20	F951C476MG1 $\times$ 2 F951A107MG1 $\times$ 2			*2
(47)	S-8341A50AFT		CDRH5D18/4.1 $\mu$ H	NDS335N	RB491D	F951A476MF1 $\times$ 1 F951A476MF1 $\times$ 2			*1
(48)			CDRH124/10 $\mu$ H	FTS2001	RBO81L-20	F951C476MG1 $\times$ 2 F951A107MG1 $\times$ 2			*2

\*1. CDRH5D18 + NDS335N + RB491D: For small and thin parts of which the height is 2 mm or shorter (The maximum current of an external part should be set to 1.7 A.)

\*2. CDRH124 + FTS2001 + RBO81L-20: For heavy load current (The maximum current of an external part should be set to 4.5 A.)

NOT RECOMMENDED FOR DESIGN

**Table 15 External Parts for Output Current vs. Ripple Voltage Characteristics Data for C Type**

No.	Product Name	Output Voltage	Inductor	Transistor	Diode	Output Capacitor	Sense Resistor	Application
(49)	S-8340C25AFT	2.5 V	CDRH6D28/10 $\mu$ H	FDN335N	RB491D	F951C476MG1 $\times$ 1 F951C476MG1 $\times$ 2	0 $\Omega$	*3
(50)			CDRH124/10 $\mu$ H	FTS2001	RBO81L-20	F951C476MG1 $\times$ 2 F951A107MG1 $\times$ 2		*4
(51)	S-8341C25AFT		CDRH6D28/10 $\mu$ H	FDN335N	RB491D	F951C476MG1 $\times$ 1 F951C476MG1 $\times$ 2		*3
(52)			CDRH124/10 $\mu$ H	FTS2001	RBO81L-20	F951C476MG1 $\times$ 2 F951A107MG1 $\times$ 2		*4
(53)	S-8340C33AFT	3.3 V	CDRH6D28/10 $\mu$ H	FDN335N	RB491D	F951C476MG1 $\times$ 1 F951C476MG1 $\times$ 2		*3
(54)			CDRH124/10 $\mu$ H	FTS2001	RBO81L-20	F951C476MG1 $\times$ 2 F951A107MG1 $\times$ 2		*4
(55)	S-8341C33AFT		CDRH6D28/10 $\mu$ H	FDN335N	RB491D	F951C476MG1 $\times$ 1 F951C476MG1 $\times$ 2	*3	
(56)			CDRH124/10 $\mu$ H	FTS2001	RBO81L-20	F951C476MG1 $\times$ 2 F951A107MG1 $\times$ 2	*4	
(57)	S-8340C50AFT	5.0 V	CDRH6D28/10 $\mu$ H	FDN335N	RB491D	F951C476MG1 $\times$ 1 F951C476MG1 $\times$ 2	*3	
(58)			CDRH124/10 $\mu$ H	FTS2001	RBO81L-20	F951C476MG1 $\times$ 2 F951A107MG1 $\times$ 2	*4	
(59)	S-8341C50AFT		CDRH6D28/10 $\mu$ H	FDN335N	RB491D	F951C476MG1 $\times$ 1 F951C476MG1 $\times$ 2	*3	
(60)			CDRH124/10 $\mu$ H	FTS2001	RBO81L-20	F951C476MG1 $\times$ 2 F951A107MG1 $\times$ 2	*4	

\*3. CDRH6D28 + FDN335N + RB491D: For part heights of 3 mm and high efficiency

\*4. CDRH124 + FTS2001 + RBO81L-20: For optimizing the load current driveability

NOT RECOMMENDED FOR DESIGN

**Performance Data for Parts**

The following shows the performance of external parts.

**Table 16 Performance of External Parts**

Component	Product Name	Manufacturer	Performance				
			L	DC resistance	Max. Current	Diameter	Height
Inductor	CDRH5D18	Sumida Corporation	4.1 $\mu$ H	0.042 $\Omega$ typ. 0.057 $\Omega$ max.	1.95 A	5.7 mm typ. 6.0 mm max.	1.8 mm typ. 2.0 mm max.
	CDRH124		10 $\mu$ H	0.028 $\Omega$ max.	4.5 A	12.0 mm typ. 12.3 mm max.	4.5 mm max.
	CDRH6D28		10 $\mu$ H	0.048 $\Omega$ typ. 0.065 $\Omega$ max.	1.70 A	6.7 mm typ. 7.0 mm max.	3.0 mm max.
Diode	RB491D	Rohm Corporation	Forward current 1.0 A @ $V_F = 0.45$ V, $V_{rm} = 25$ V				
	RB081L-20		Forward current 5.0 A @ $V_F = 0.45$ V, $V_{rm} = 25$ V				
Capacitor (output capacitance) (tantalum electrolytic capacitor)	F951C476MG1	Nichicon Corporation	47 $\mu$ F, 16 V, 5.5 $\times$ 4.8 $\times$ 2.3 mm max., ESR = 0.08 $\Omega$ (nominal value)				
	F951A476MF1		47 $\mu$ F, 10 V, 5.5 $\times$ 4.8 $\times$ 2.0 mm max., ESR = 0.1 $\Omega$ (nominal value)				
	F920J476MB3		47 $\mu$ F, 6.3 V, 3.6 $\times$ 3 $\times$ 1.2 mm max., ESR = 0.27 $\Omega$ (nominal value)				
	F951A107MG1		100 $\mu$ F, 10 V, 5.5 $\times$ 4.8 $\times$ 2.3 mm max., ESR = 0.08 $\Omega$ (nominal value)				
External transistor (N-channel FET)	NDS335N*1	Fairchild Semiconductor Corporation	$V_{DSS} = 20$ V max., $V_{GSS} = 8$ V max., $I_D = 1.7$ A max., $V_{th} = 0.5$ V to 1 V, $C_{iss} = 240$ pF typ., $R_{DS(ON)} = 0.14$ $\Omega$ max. ( $V_{GS} = 2.7$ V), SOT-23-3 package or equivalent				
	FDN335N		$V_{DSS} = 20$ V max., $V_{GSS} = 8$ V max., $I_D = 1.7$ A max., $V_{th} = 0.4$ V to 1.5 V, $C_{iss} = 310$ pF typ., $R_{DS(ON)} = 0.10$ $\Omega$ max. ( $V_{GS} = 2.5$ V), SOT-23-3 package or equivalent				
	FTS2001	Sanyo Electric Co., Ltd.	$V_{DSS} = 20$ V max., $V_{GSS} = 8$ V max., $I_D = 5$ A max., $V_{th} = 0.4$ V to 1.3 V, $C_{iss} = 750$ pF typ., $R_{DS(ON)} = 0.046$ $\Omega$ max. ( $V_{GS} = 2.5$ V), 8-Pin TSSOP package				

\*1. The manufacturer recommends the FDN335N as an alternative for the NDS335N.

**Caution** The value of each characteristic in Table 16 depends on the materials prepared by each manufacturer, however, confirm the specifications by referring to respective materials when using any of the above.

**2. Output Current ( $I_{OUT}$ ) vs. Efficiency ( $\eta$ ) Characteristics**

The following shows the actual output current ( $I_{OUT}$ ) vs. efficiency ( $\eta$ ) characteristics when the S-8340/8341 Series is used under conditions (1) to (24) in Tables 10 and 11.

**(1) S-8340A25AFT**

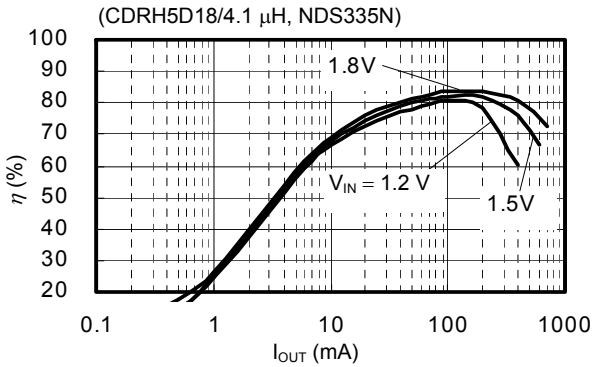

**(2) S-8340A25AFT**

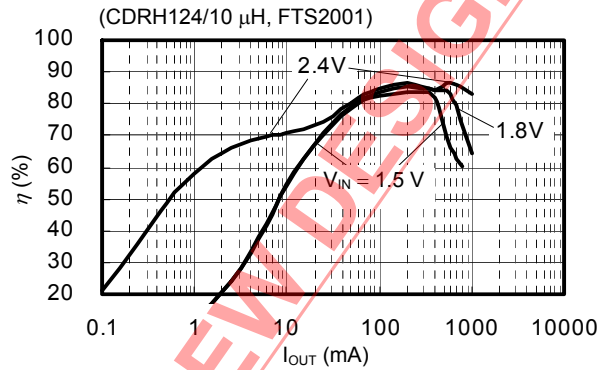

**(3) S-8341A25AFT**

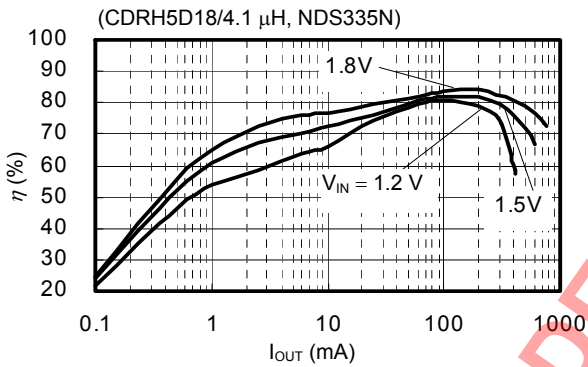

**(4) S-8341A25AFT**

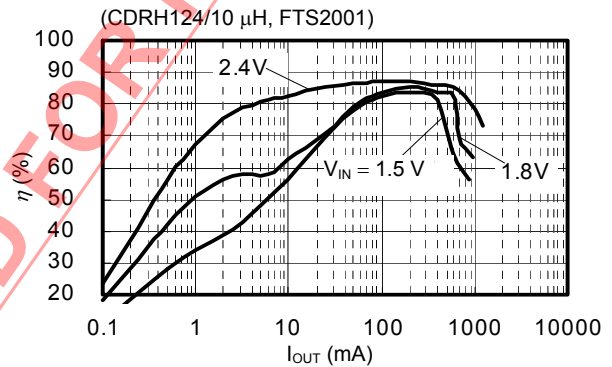

**(5) S-8340A33AFT**

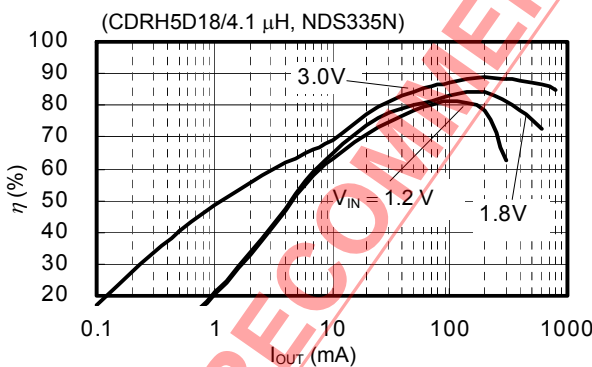

**(6) S-8340A33AFT**

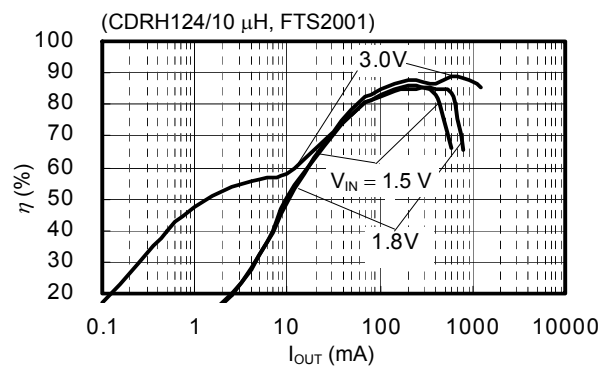

**(7) S-8341A33AFT**

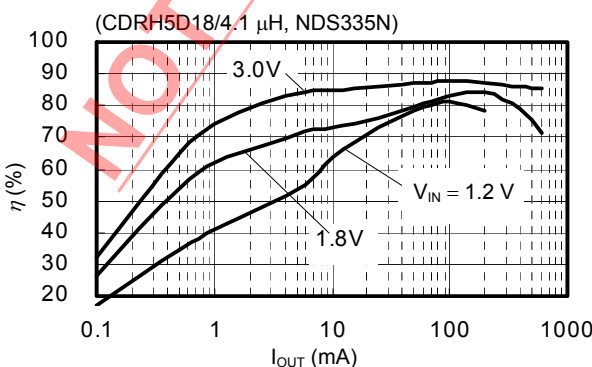

**(8) S-8341A33AFT**

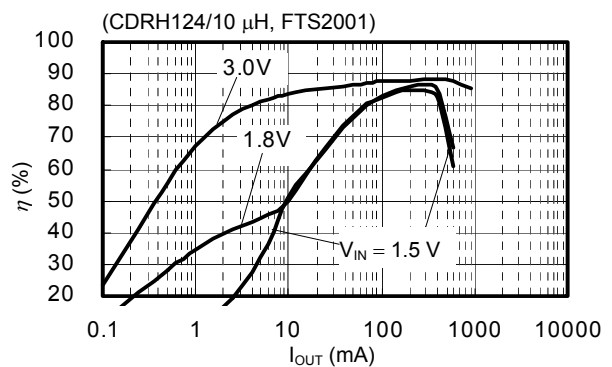

**(9) S-8340A50AFT**

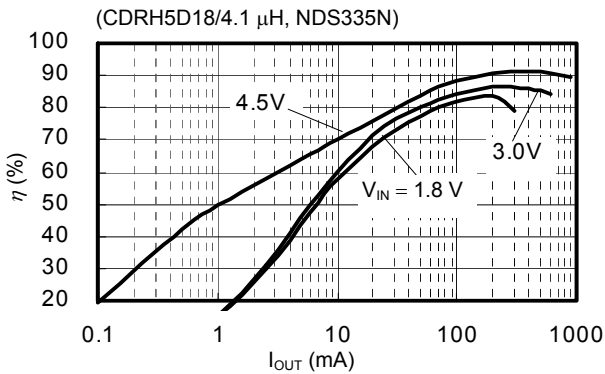

**(10) S-8340A50AFT**

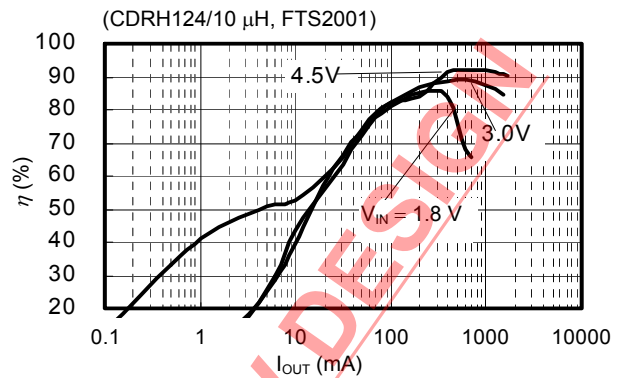

**(11) S-8341A50AFT**

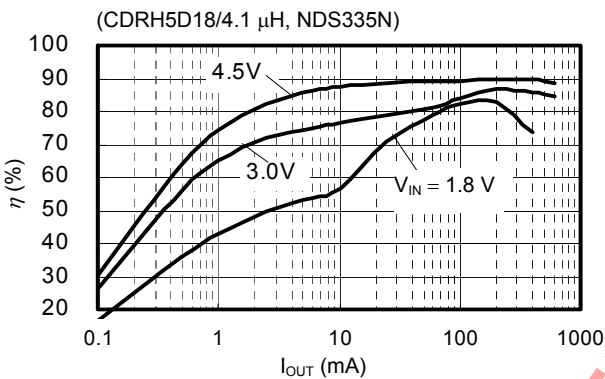

**(12) S-8341A50AFT**

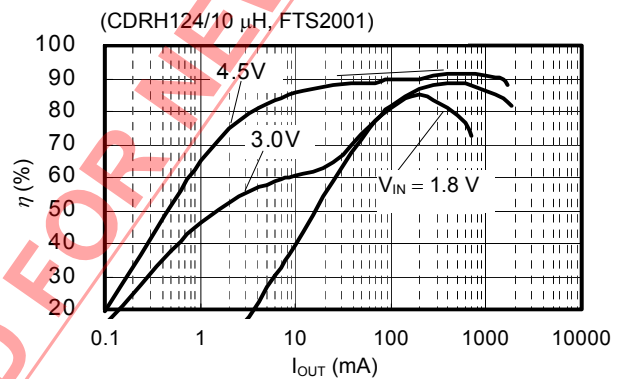

**(13) S-8340C25AFT**

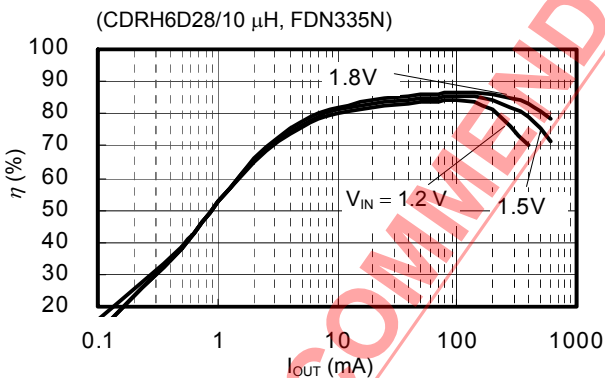

**(14) S-8340C25AFT**

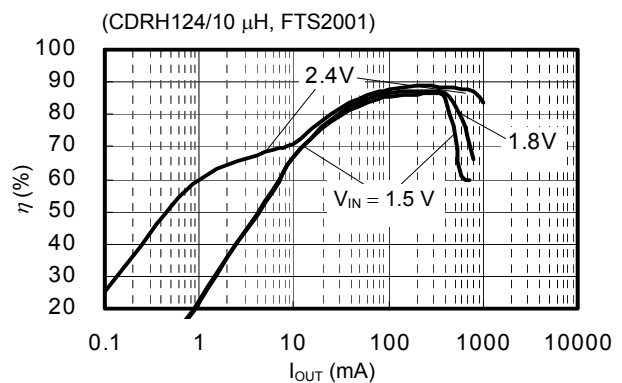

**(15) S-8341C25AFT**

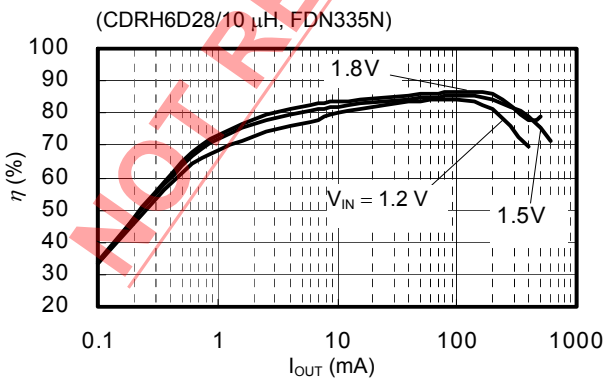

**(16) S-8341C25AFT**

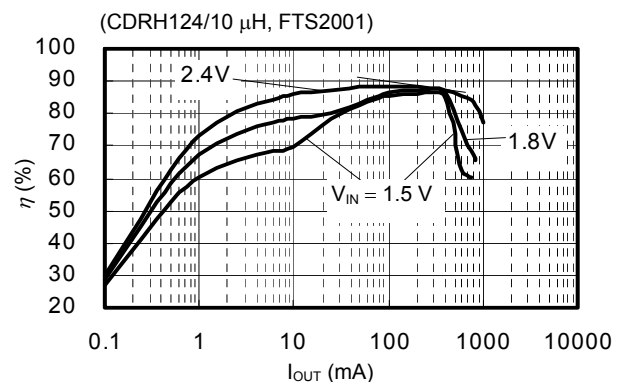

(17) S-8340C33AFT

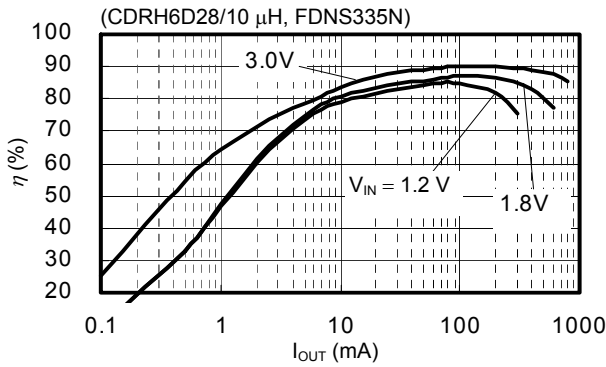

(18) S-8340C33AFT

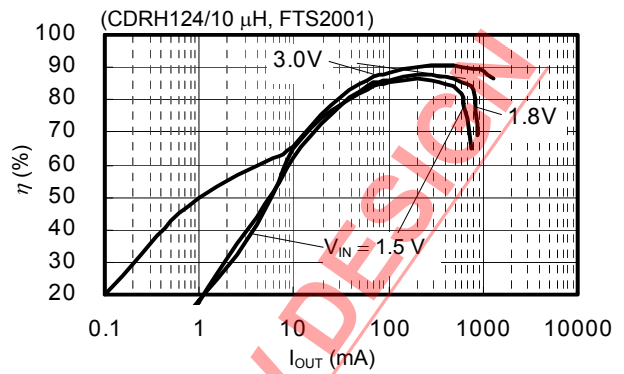

(19) S-8341C33AFT

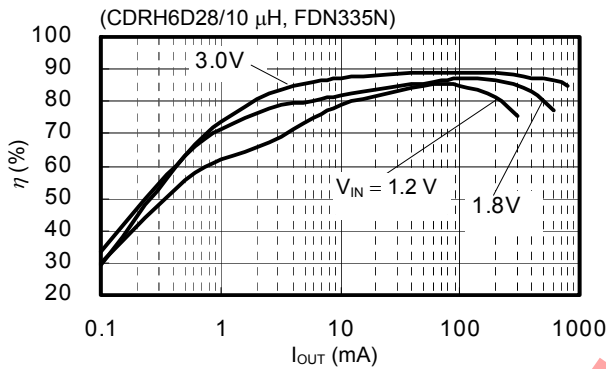

(20) S-8341C33AFT

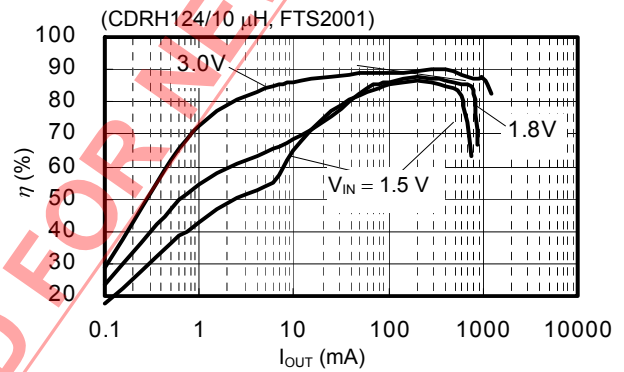

(21) S-8340C50AFT

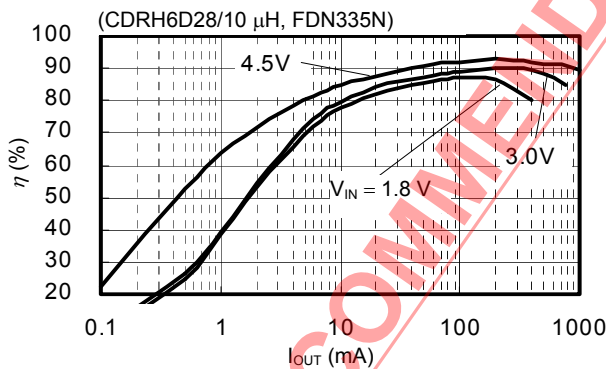

(22) S-8340C50AFT

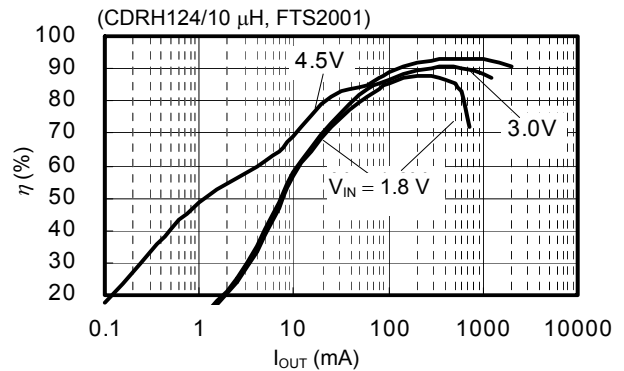

(23) S-8341C50AFT

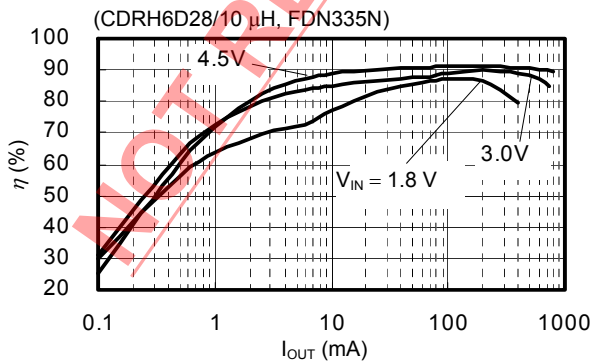

(24) S-8341C50AFT

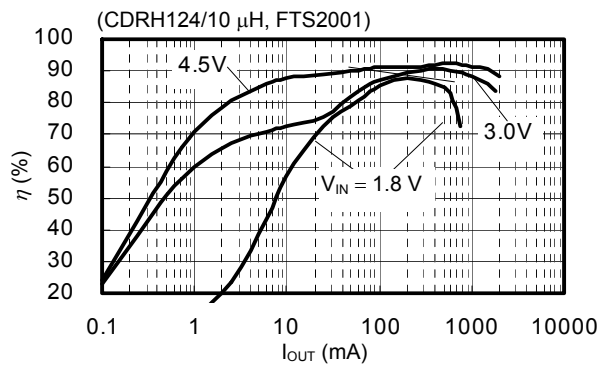



**3. Output Current ( $I_{OUT}$ ) vs. Output Voltage ( $V_{OUT}$ ) Characteristics**

The following shows the actual output current ( $I_{OUT}$ ) vs. output voltage ( $V_{OUT}$ ) characteristics when the S-8340/8341 Series is used under conditions (1) to (24) in **Tables 10** and **11**.

**(1) S-8340A25AFT**

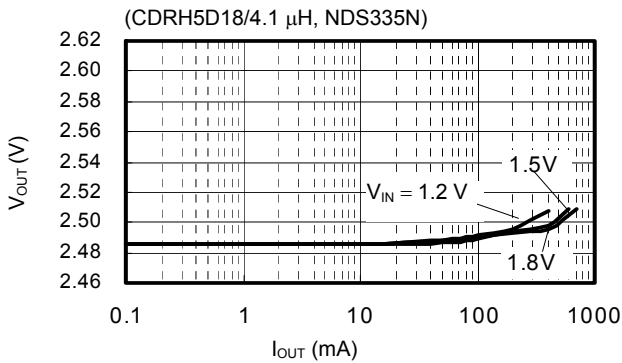

**(2) S-8340A25AFT**

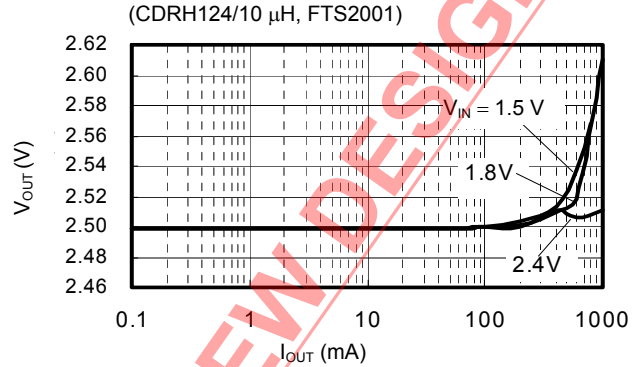

**(3) S-8341A25AFT**

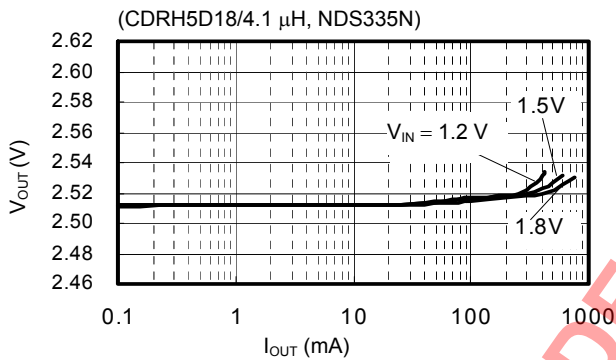

**(4) S-8341A25AFT**

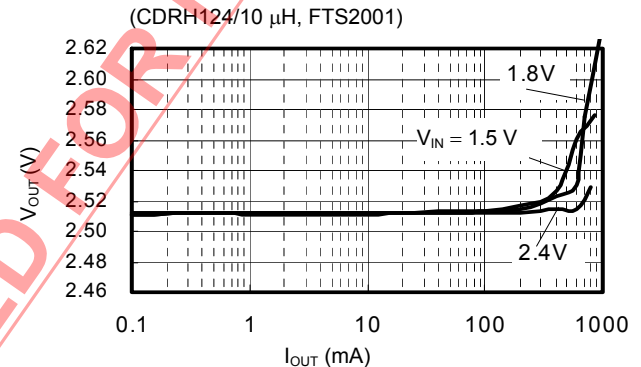

**(5) S-8340A33AFT**

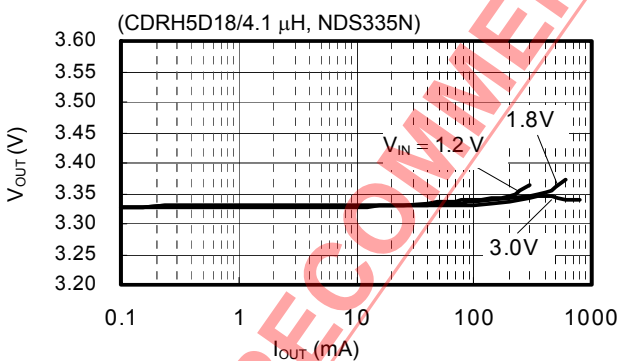

**(6) S-8340A33AFT**

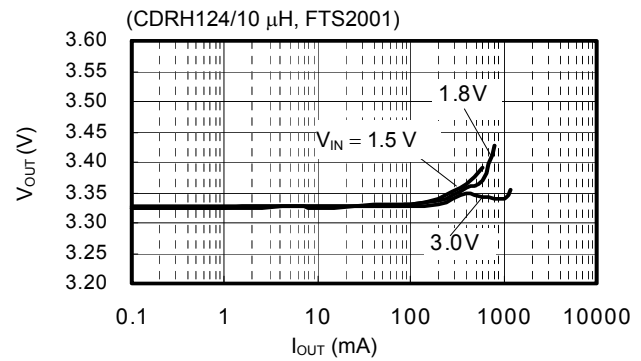

**(7) S-8341A33AFT**

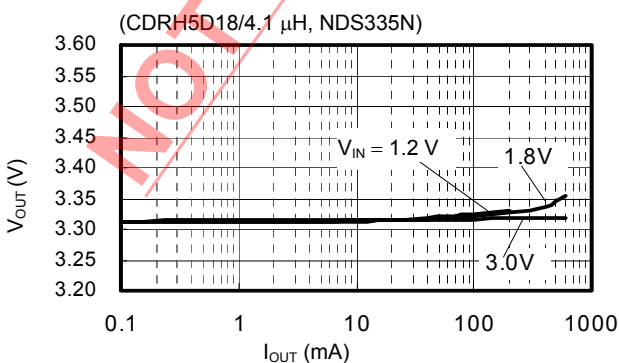

**(8) S-8341A33AFT**

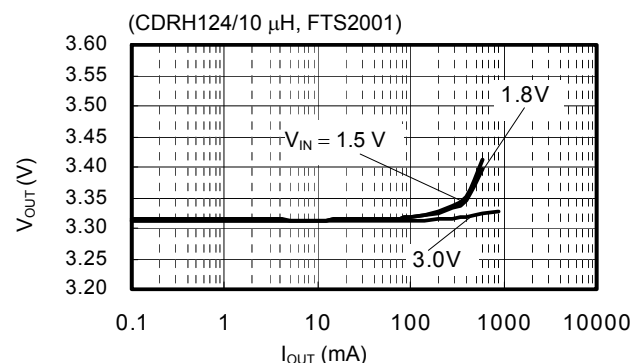



(9) S-8340A50AFT

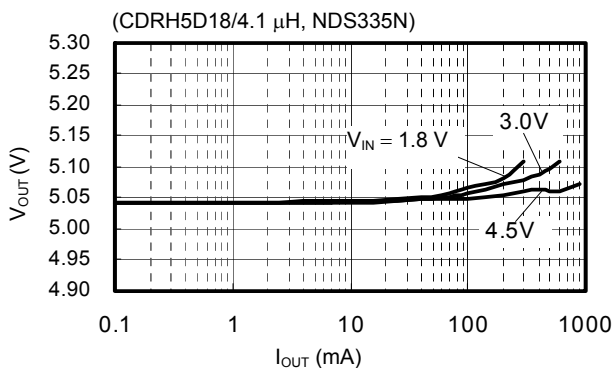

(10) S-8340A50AFT

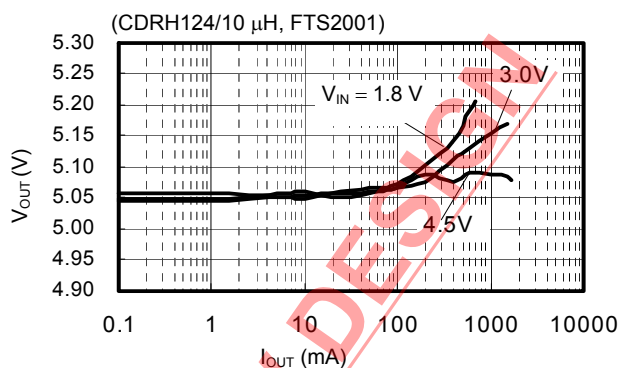

(11) S-8341A50AFT

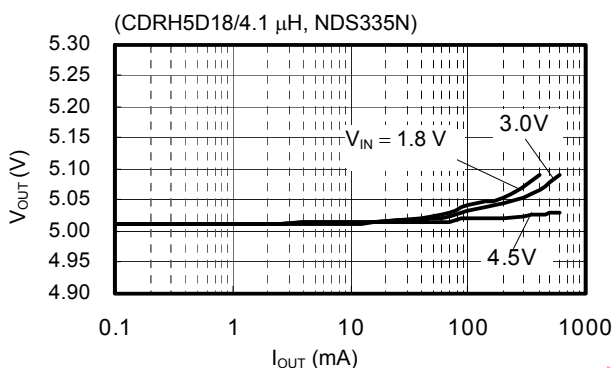

(12) S-8341A50AFT

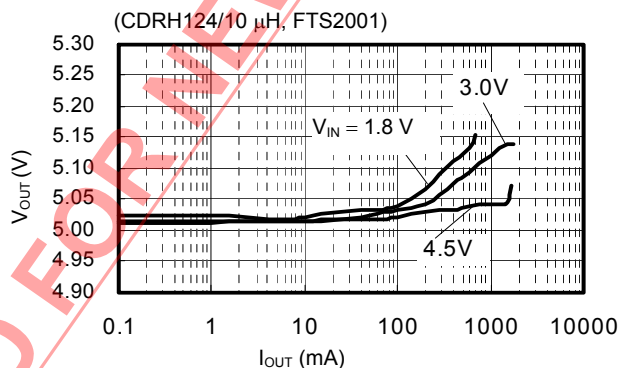

(13) S-8340C25AFT

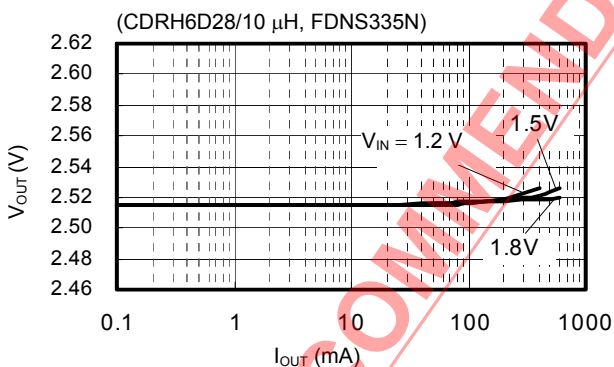

(14) S-8340C25AFT

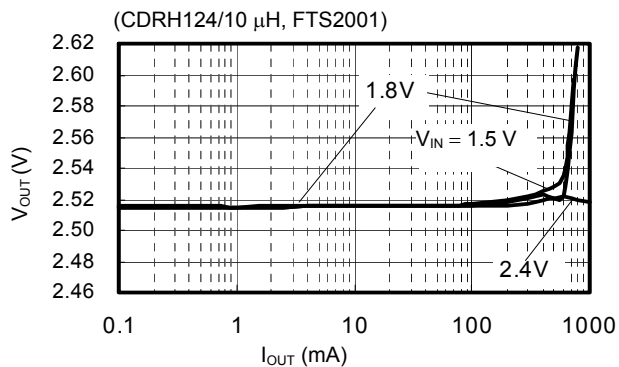

(15) S-8341C25AFT

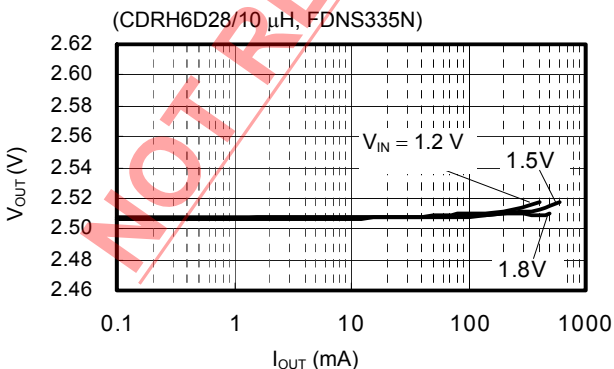

(16) S-8341C25AFT

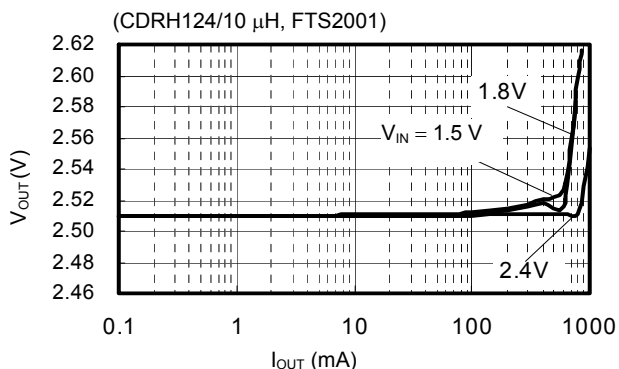

**(17) S-8340C33AFT**

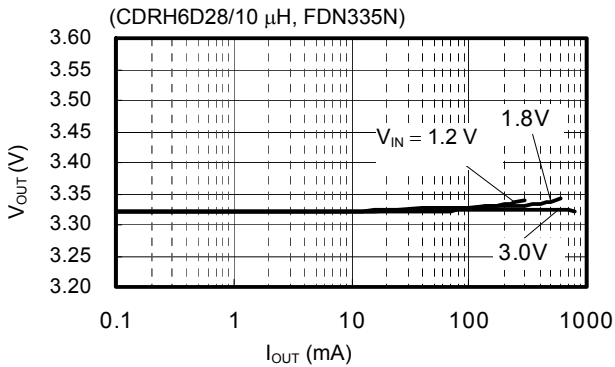

**(18) S-8340C33AFT**

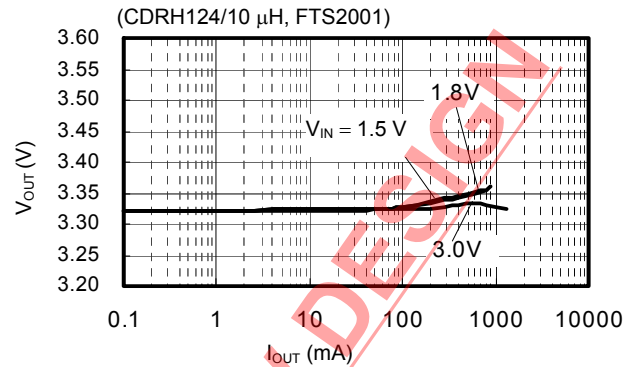

**(19) S-8341C33AFT**

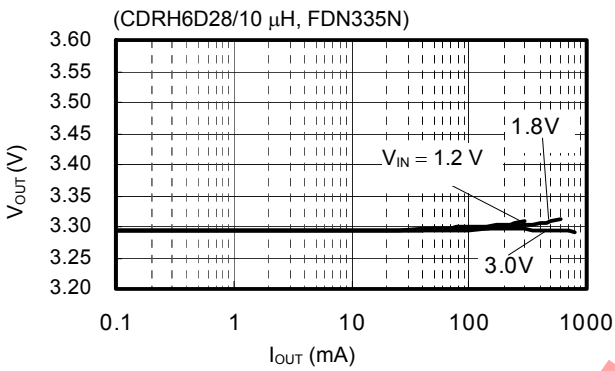

**(20) S-8341C33AFT**

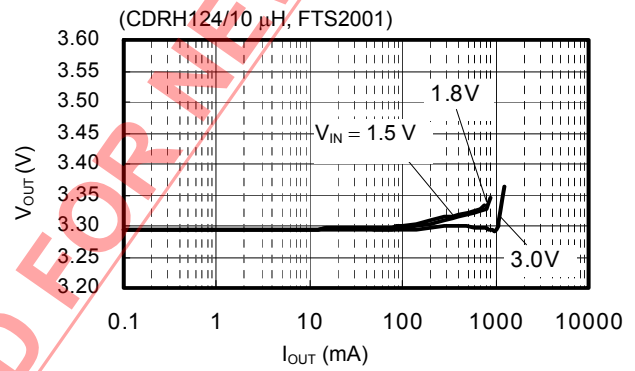

**(21) S-8340C50AFT**

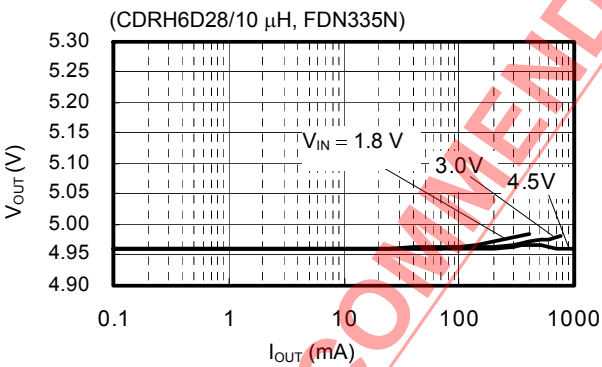

**(22) S-8340C50AFT**

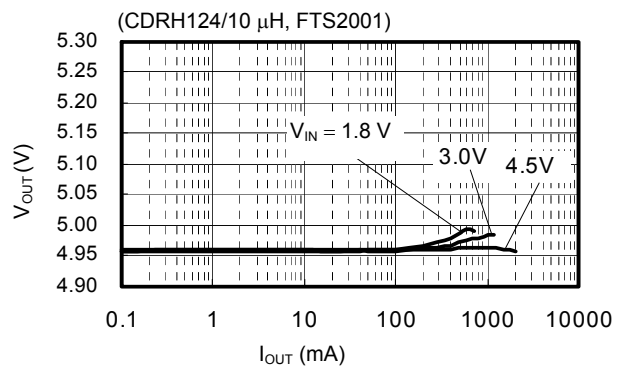

**(23) S-8341C50AFT**

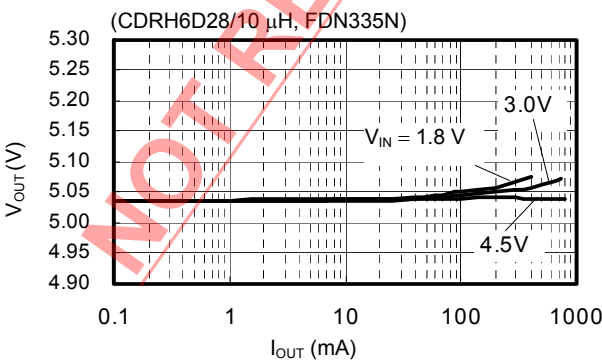

**(24) S-8341C50AFT**

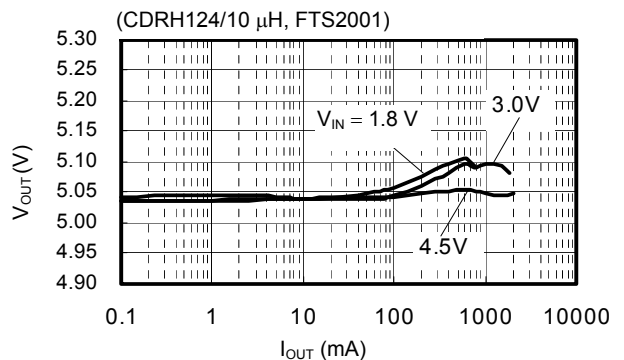

**4. Output Current ( $I_{OUT}$ ) vs. PFM/PWM Switching Input Voltage ( $V_{IN}$ ) Characteristics**

The following shows the actual output current ( $I_{OUT}$ ) vs. PFM/PWM switching input voltage ( $V_{IN}$ ) characteristics when the S-8341 Series is used under conditions (25) to (36) in Tables 12 and 13.

**(25) S-8341A25AFT**

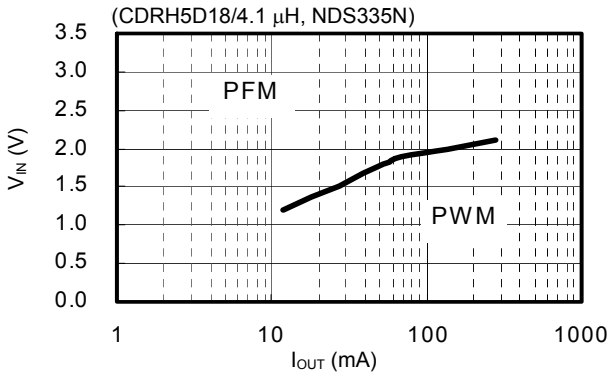

**(26) S-8341A25AFT**

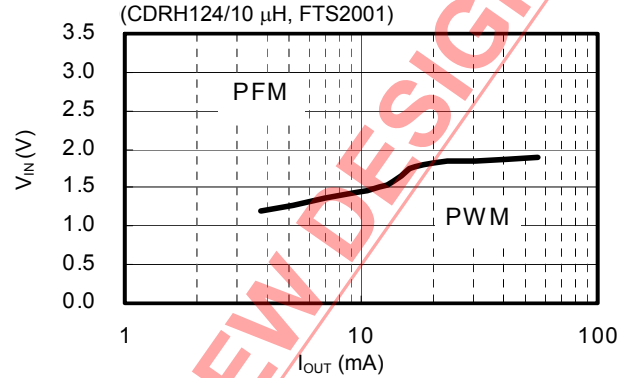

**(27) S-8341A33AFT**

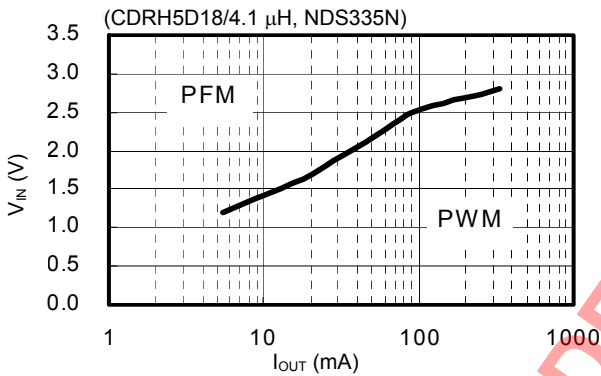

**(28) S-8341A33AFT**

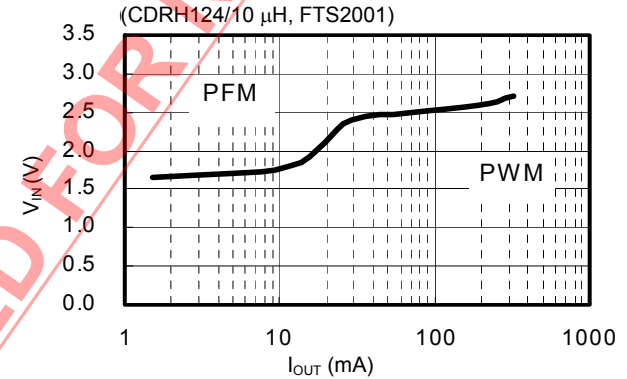

**(29) S-8341A50AFT**

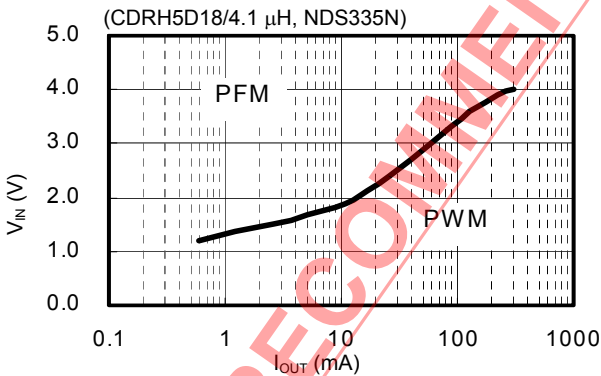

**(30) S-8341A50AFT**

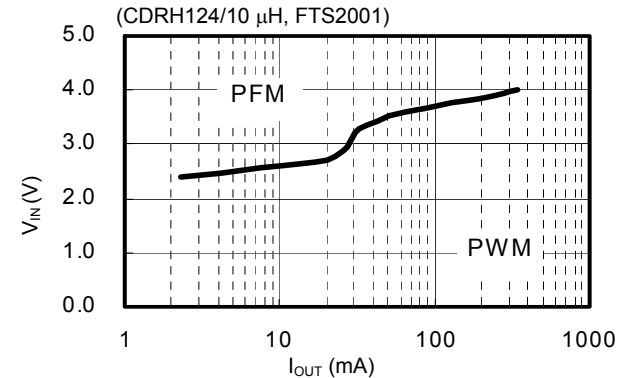

**(31) S-8341C25AFT**

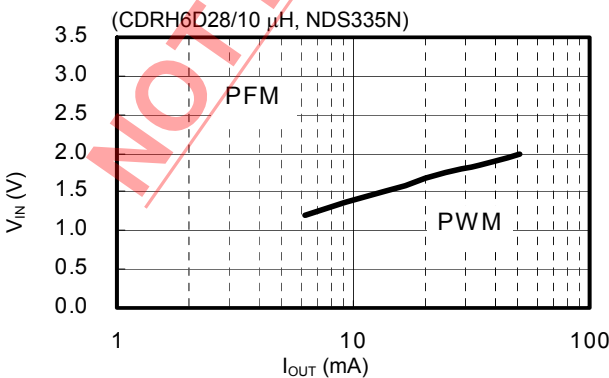

**(32) S-8341C25AFT**

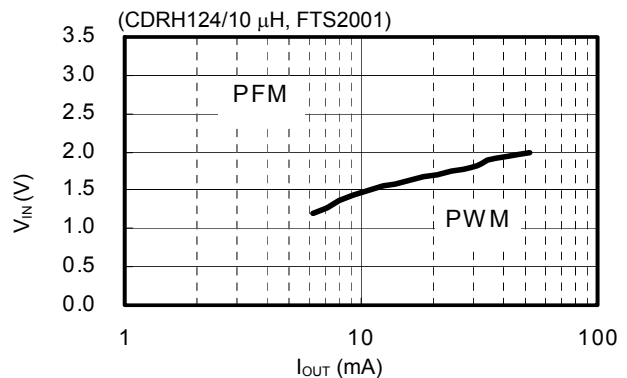

**(33) S-8341C33AFT**

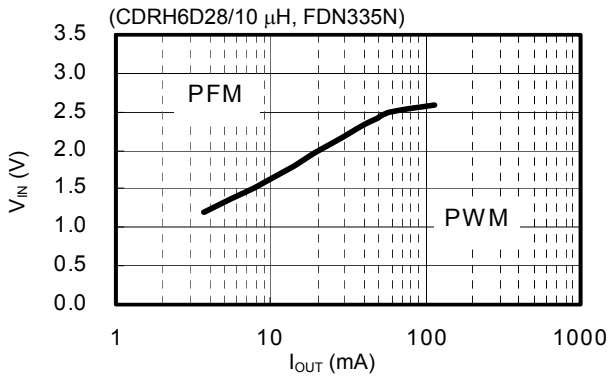

**(34) S-8341C33AFT**

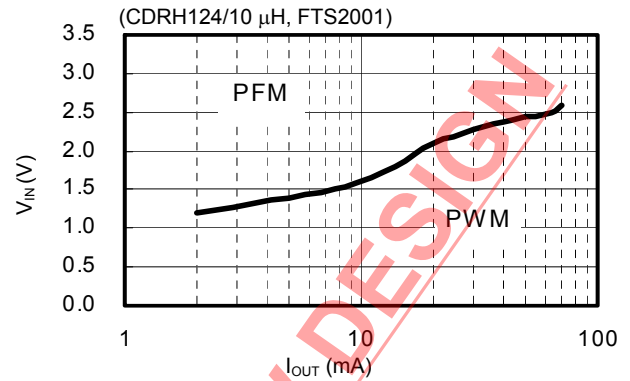

**(35) S-8341C50AFT**

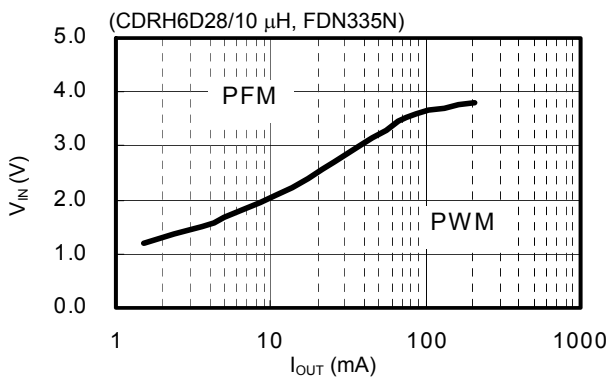

**(36) S-8341C50AFT**

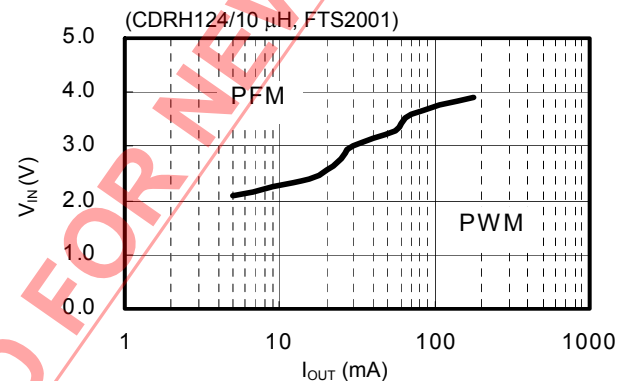

NOT RECOMMENDED FOR NEW DESIGN

**5. Output Current ( $I_{OUT}$ ) vs. Ripple Voltage (Ripple) Characteristics**

The following shows the actual output current ( $I_{OUT}$ ) vs. ripple voltage (Ripple) characteristics when the S-8340/8341 Series is used under conditions (37) to (60) in Tables 14 and 15.

**(37) S-8340A25AFT**

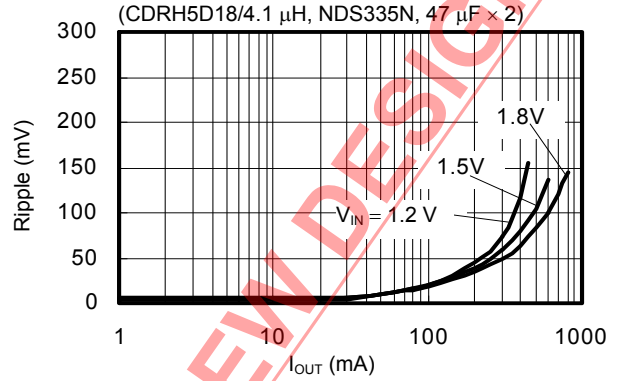
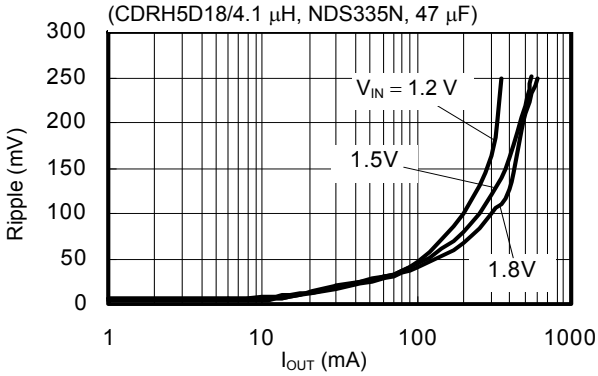

**(38) S-8340A25AFT**

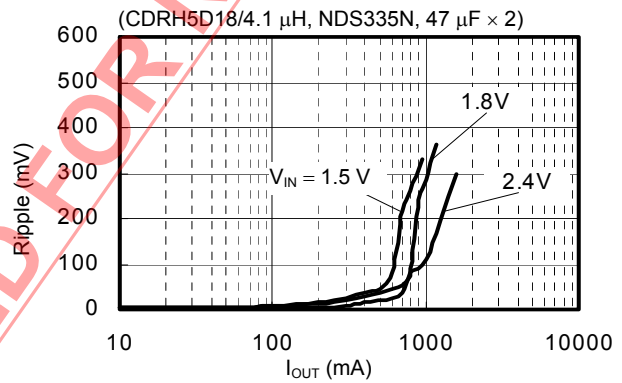
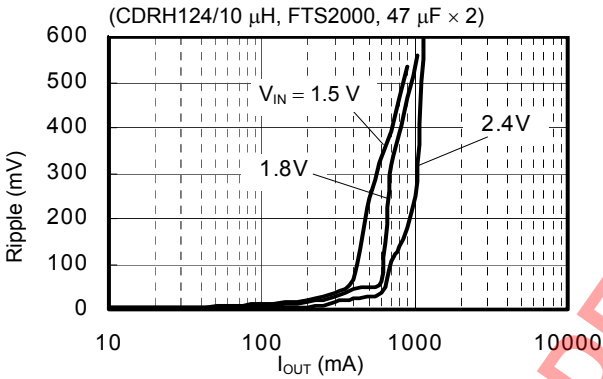

**(39) S-8341A25AFT**

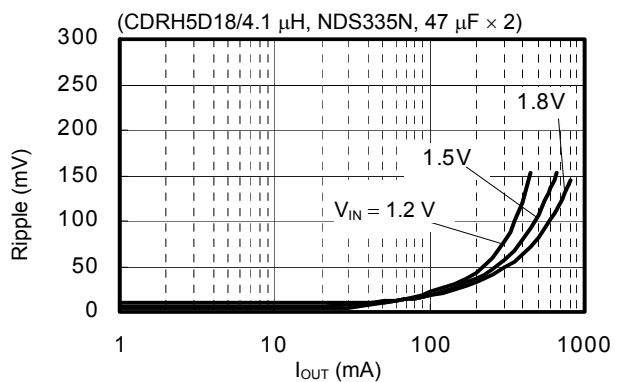
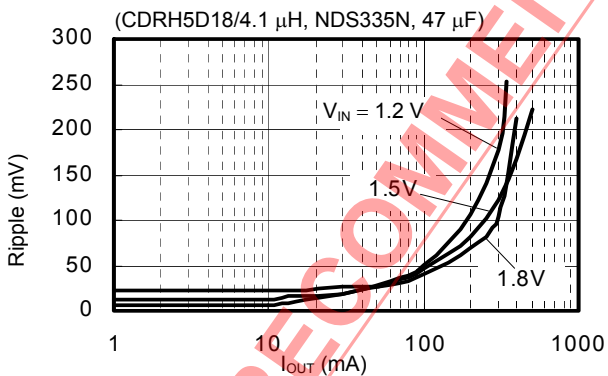

**(40) S-8341A25AFT**

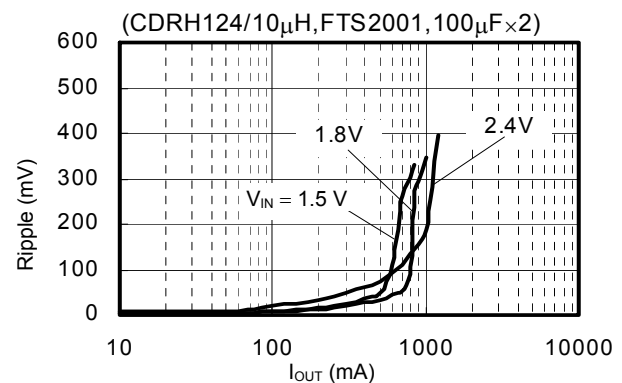
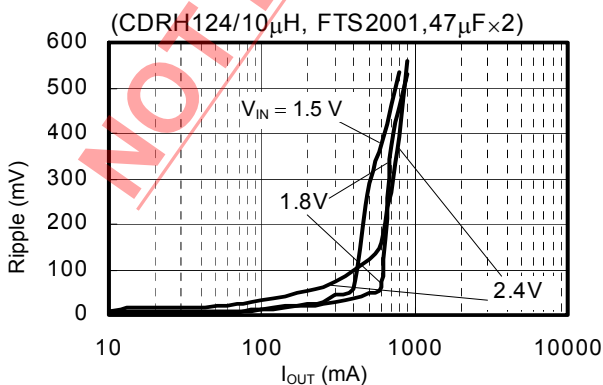

**(41) S-8340A33AFT**

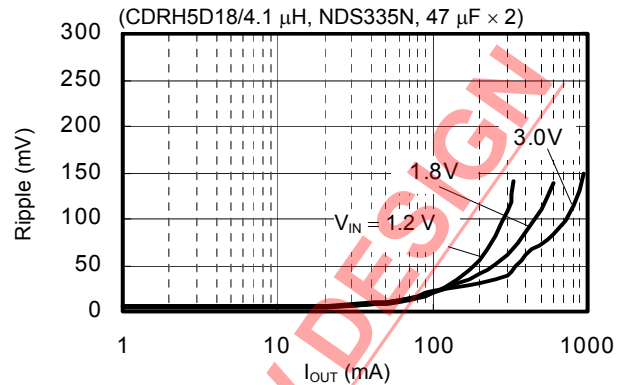
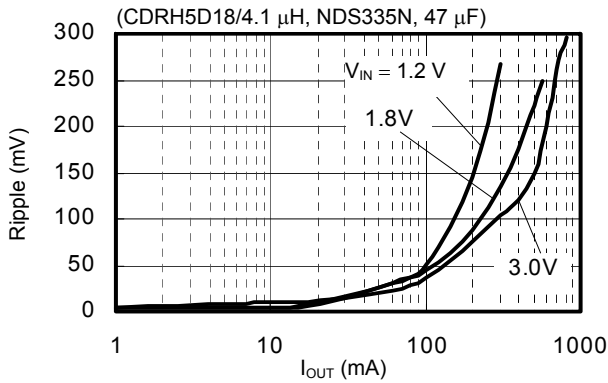

**(42) S-8340A33AFT**

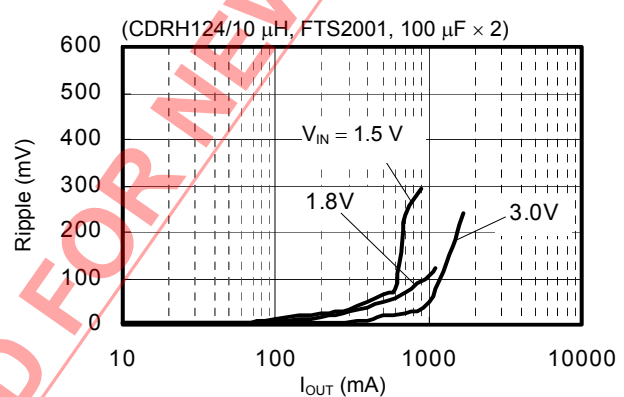
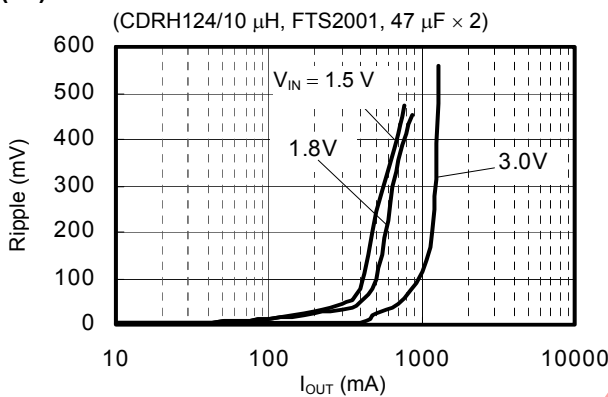

**(43) S-8341A33AFT**

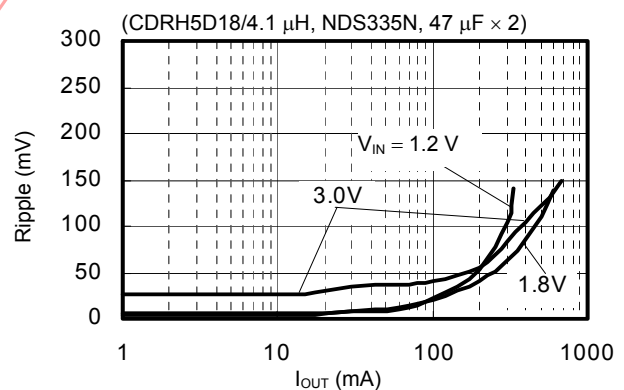
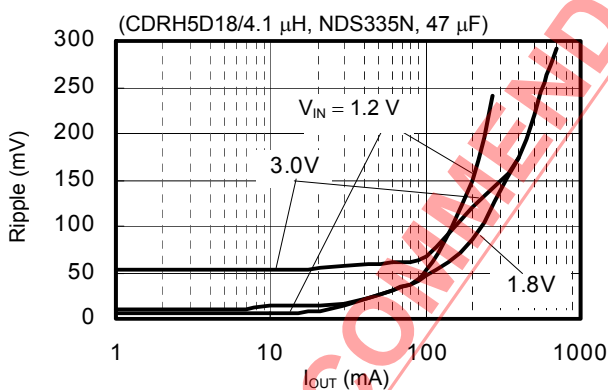

**(44) S-8341A33AFT**

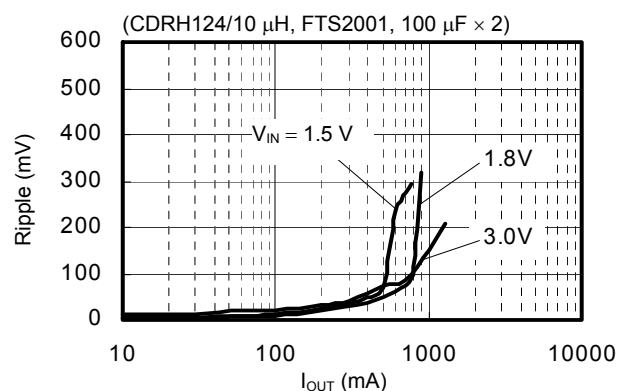
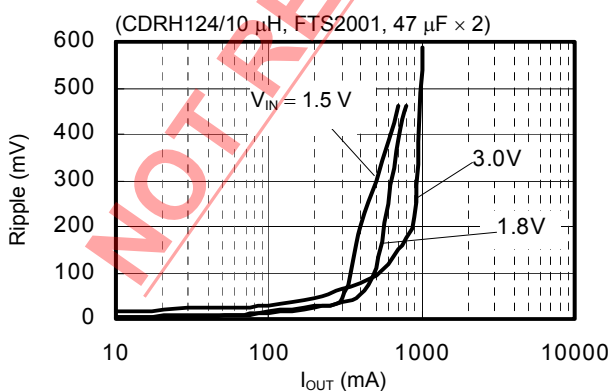

**(45) S-8340A50AFT**

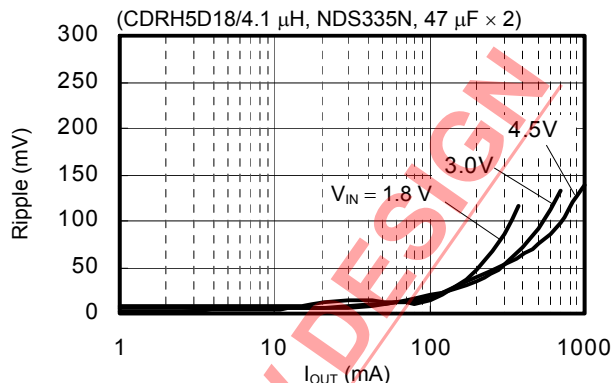
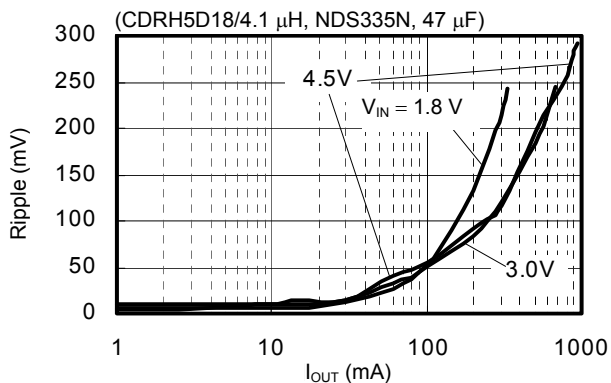

**(46) S-8340A50AFT**

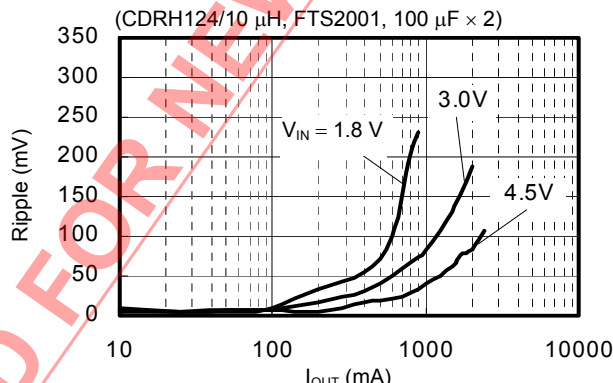
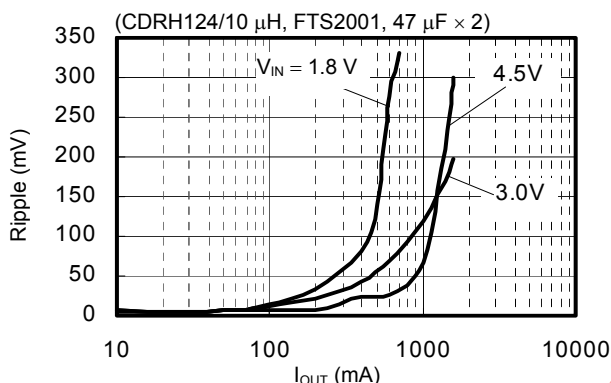

**(47) S-8341A50AFT**

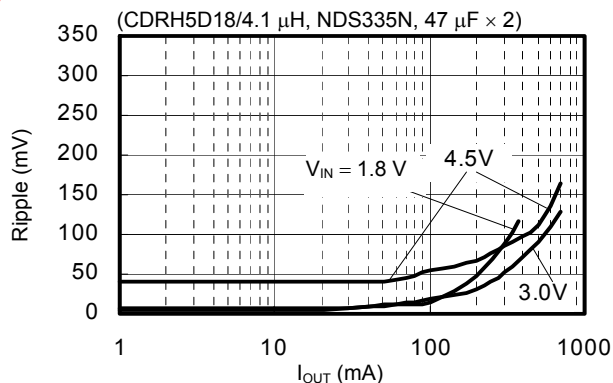
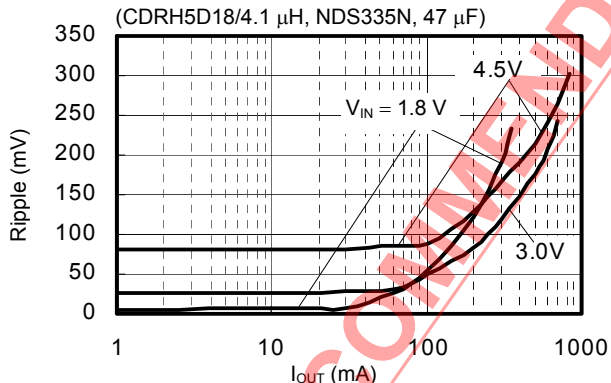

**(48) S-8341A50AFT**

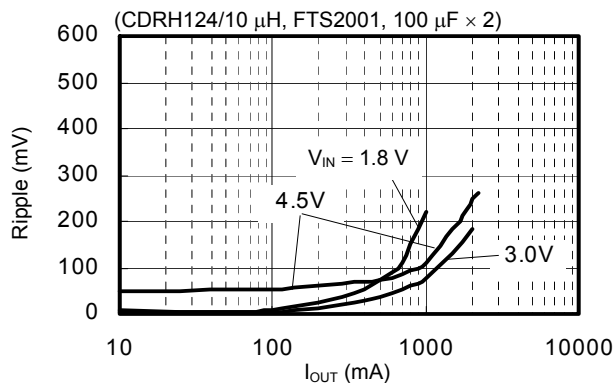
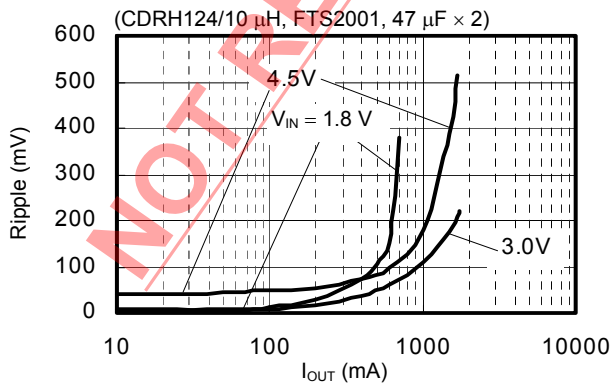

**(49) S-8340C25AFT**

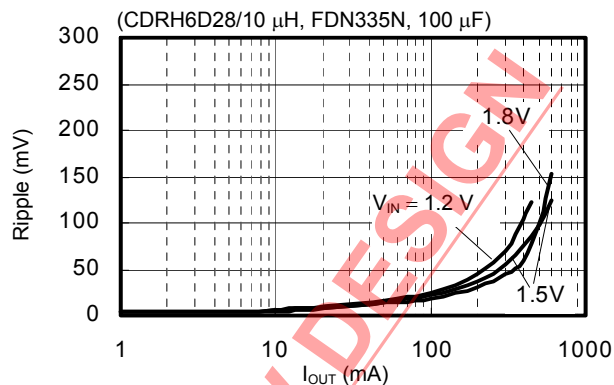
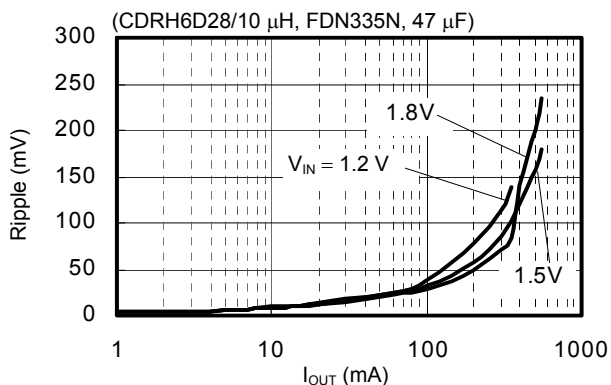

**(50) S-8340C25AFT**

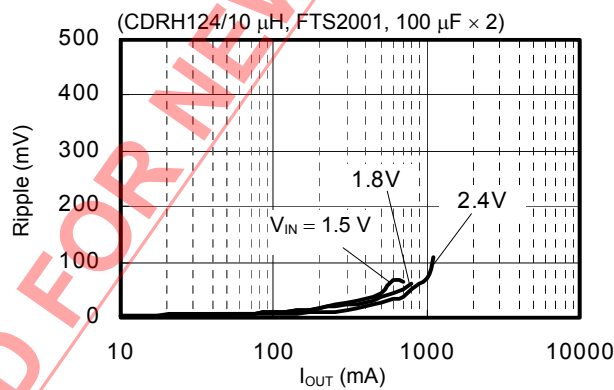
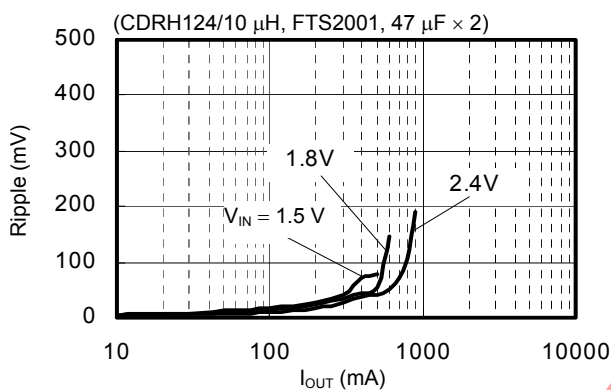

**(51) S-8341C25AFT**

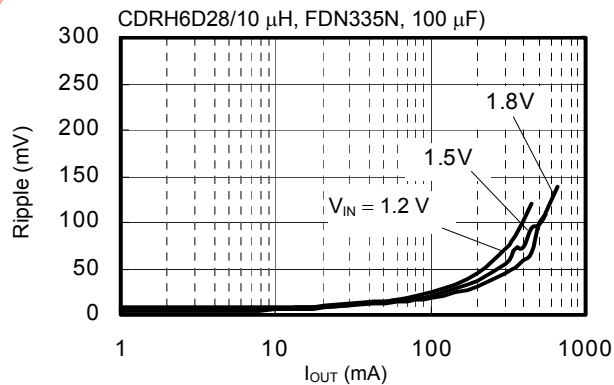
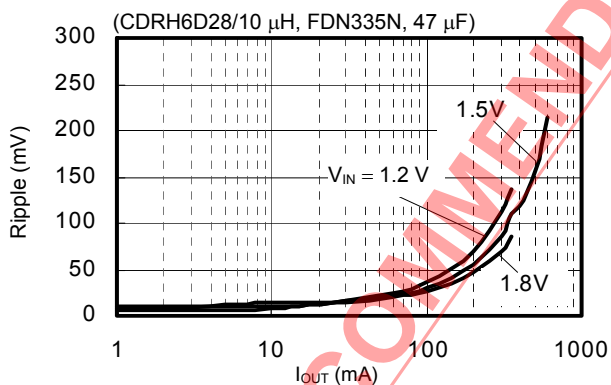

**(52) S-8341C25AFT**

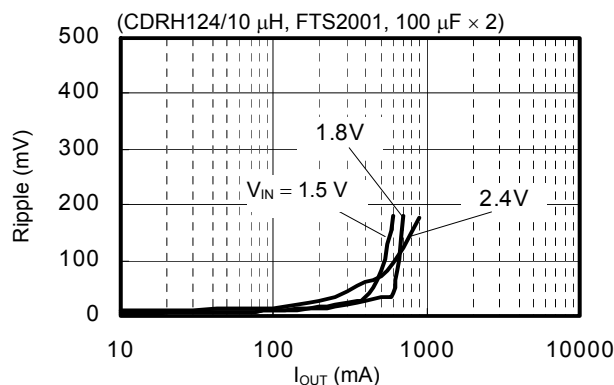
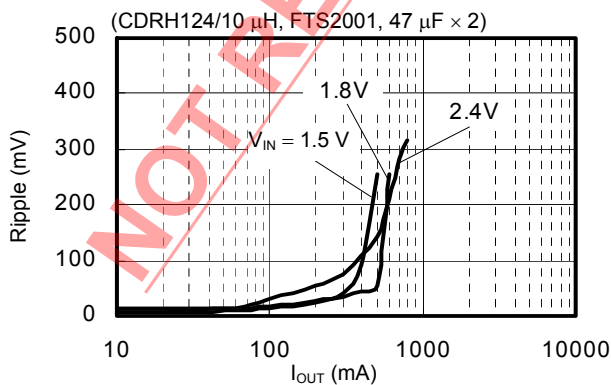



**(53) S-8340C33AFT**

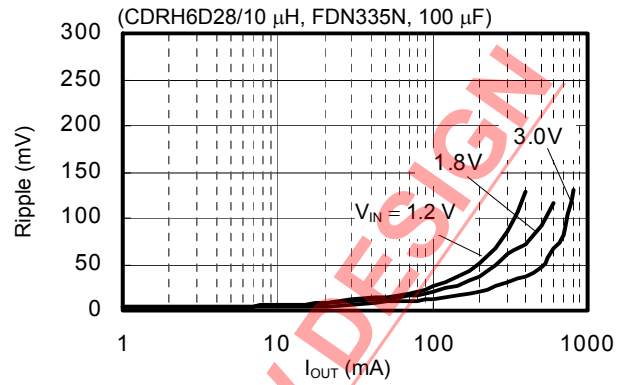
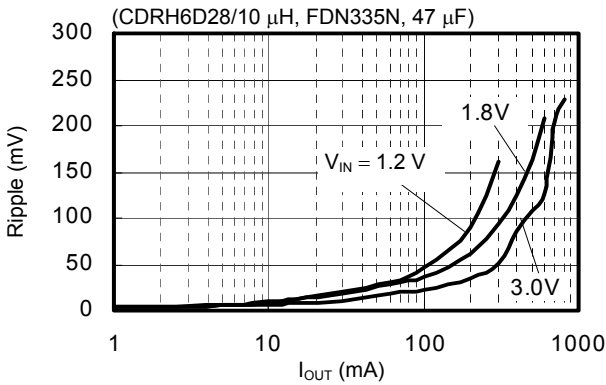

**(54) S-8340C33AFT**

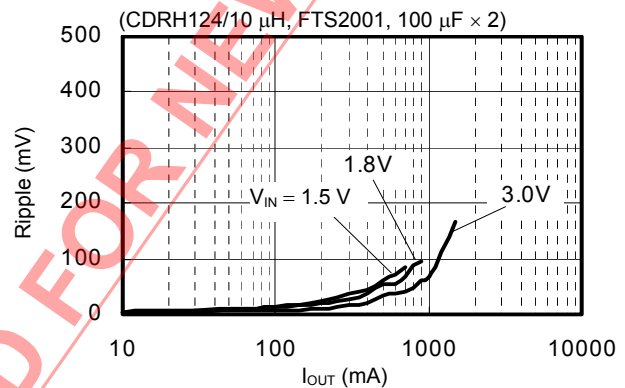
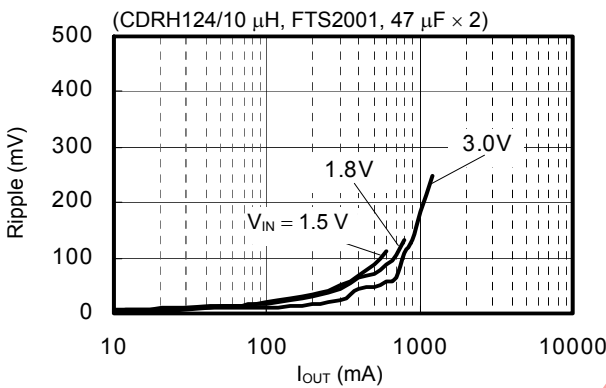

**(55) S-8341C33AFT**

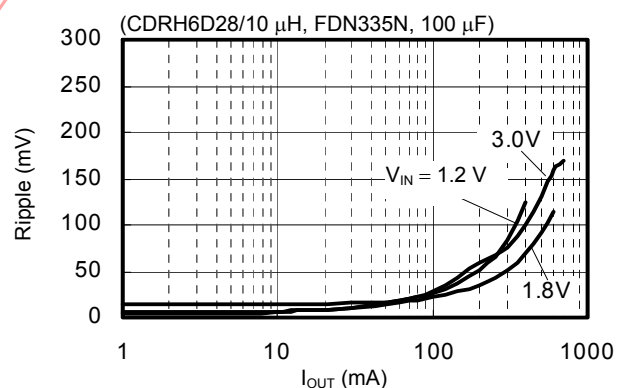
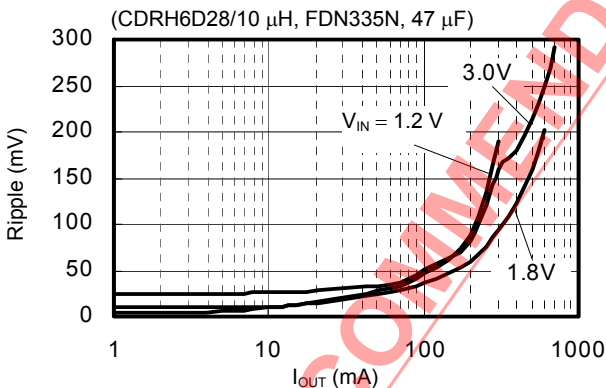

**(56) S-8341C33AFT**

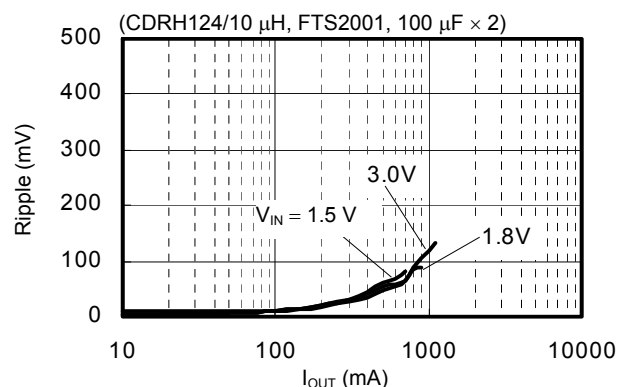
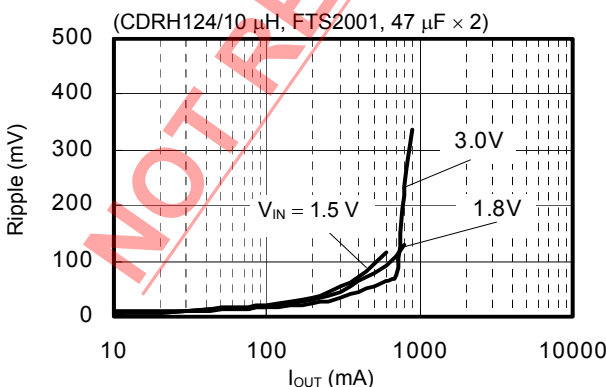

**(57) S-8340C50AFT**

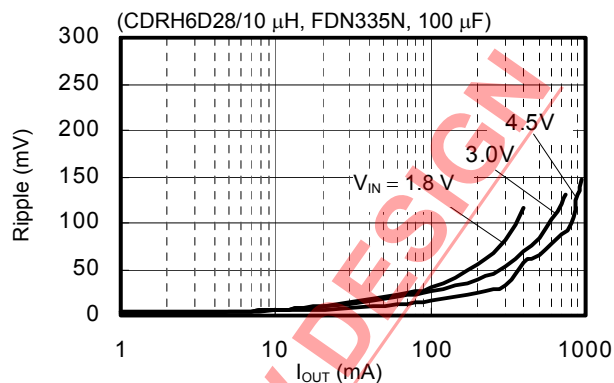
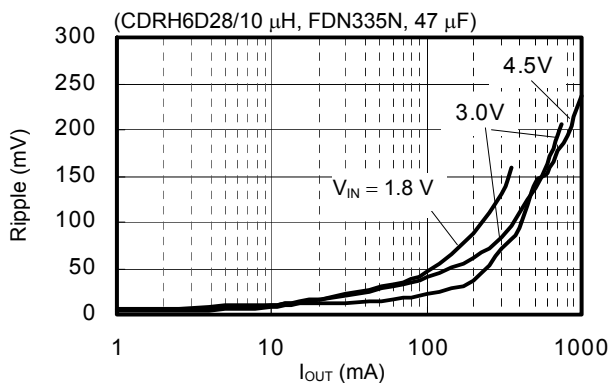

**(58) S-8340C50AFT**

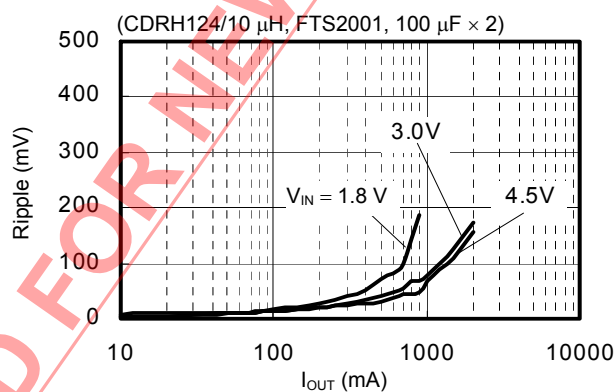
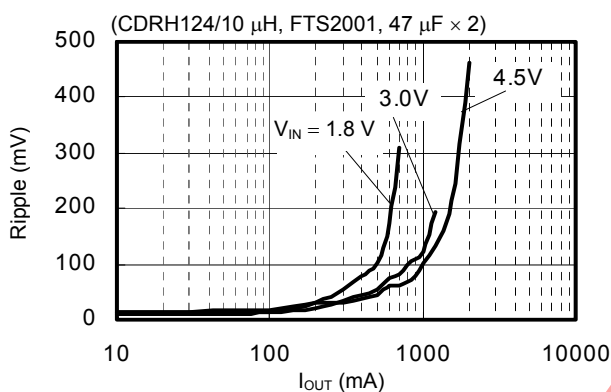

**(59) S-8341C50AFT**

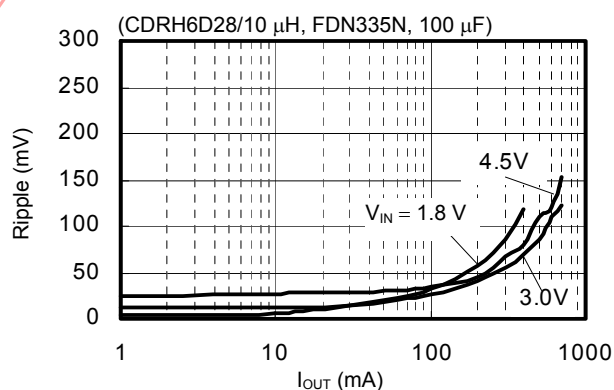
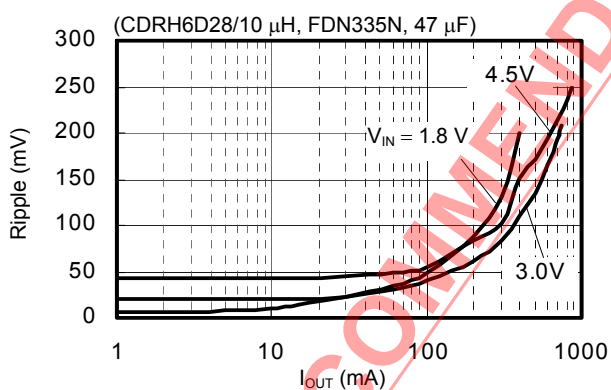

**(60) S-8341C50AFT**

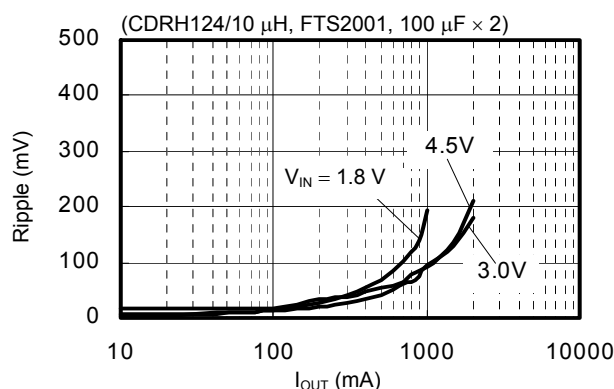
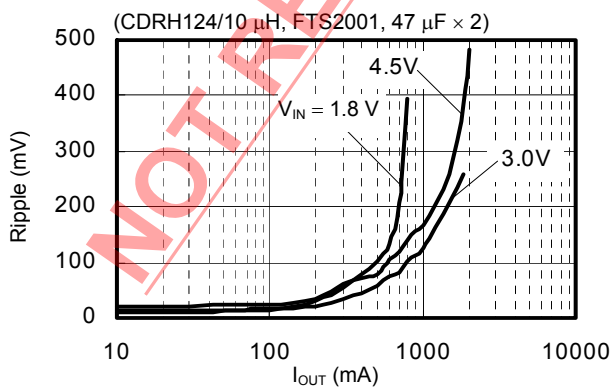

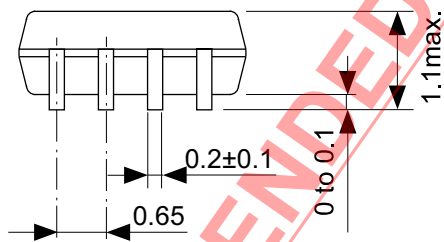
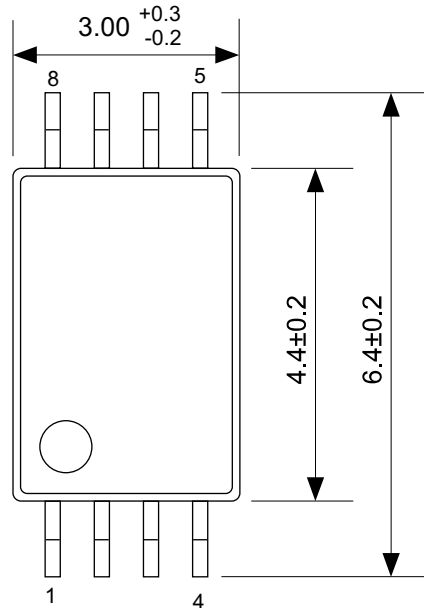

NOT RECOMMENDED FOR NEW DESIGN

No. FT008-A-P-SD-1.2

TITLE	TSSOP8-E-PKG Dimensions
No.	FT008-A-P-SD-1.2
ANGLE	
UNIT	mm
<b>ABLIC Inc.</b>	

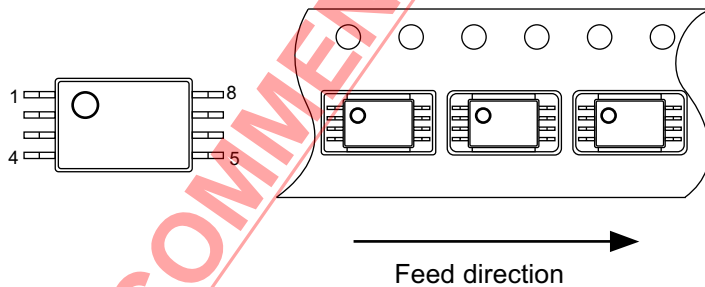
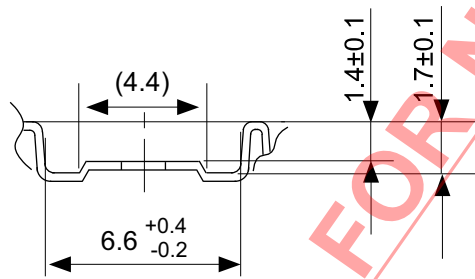
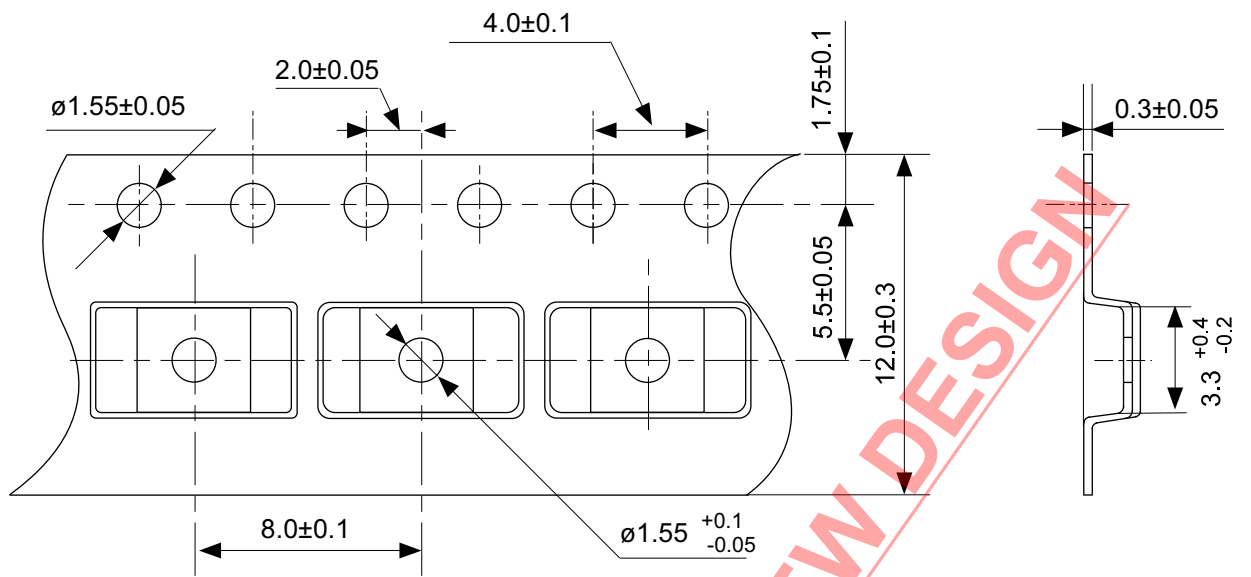

No. FT008-E-C-SD-1.0

TITLE	TSSOP8-E-Carrier Tape
No.	FT008-E-C-SD-1.0
ANGLE	
UNIT	mm
<b>ABLIC Inc.</b>	

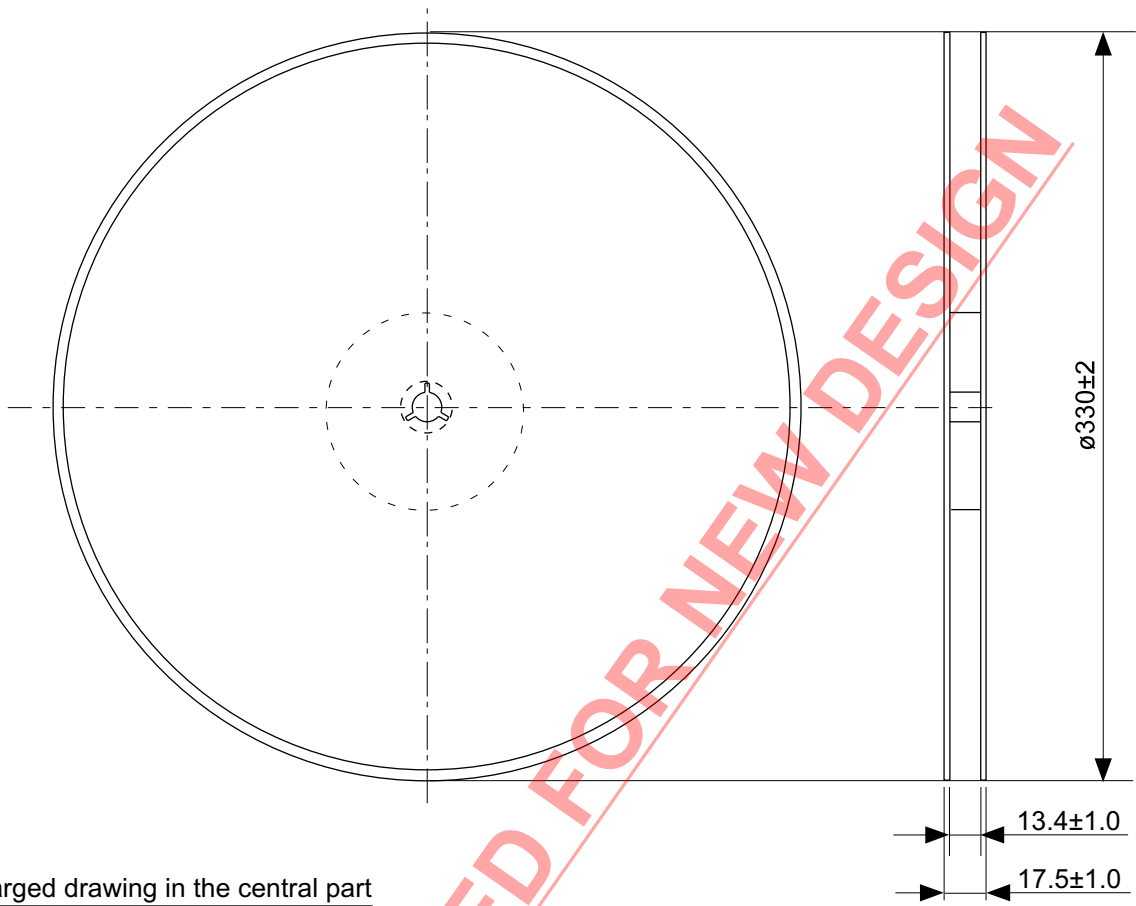

Enlarged drawing in the central part

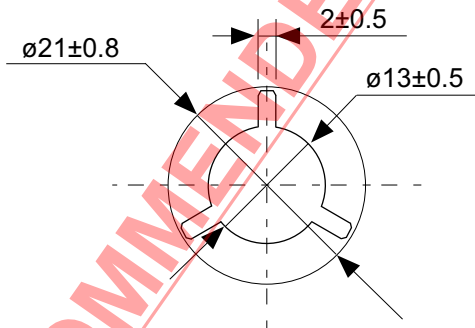

No. FT008-E-R-SD-1.0

TITLE	TSSOP8-E-Reel		
No.	FT008-E-R-SD-1.0		
ANGLE		QTY.	3,000
UNIT	mm		
<b>ABLIC Inc.</b>			

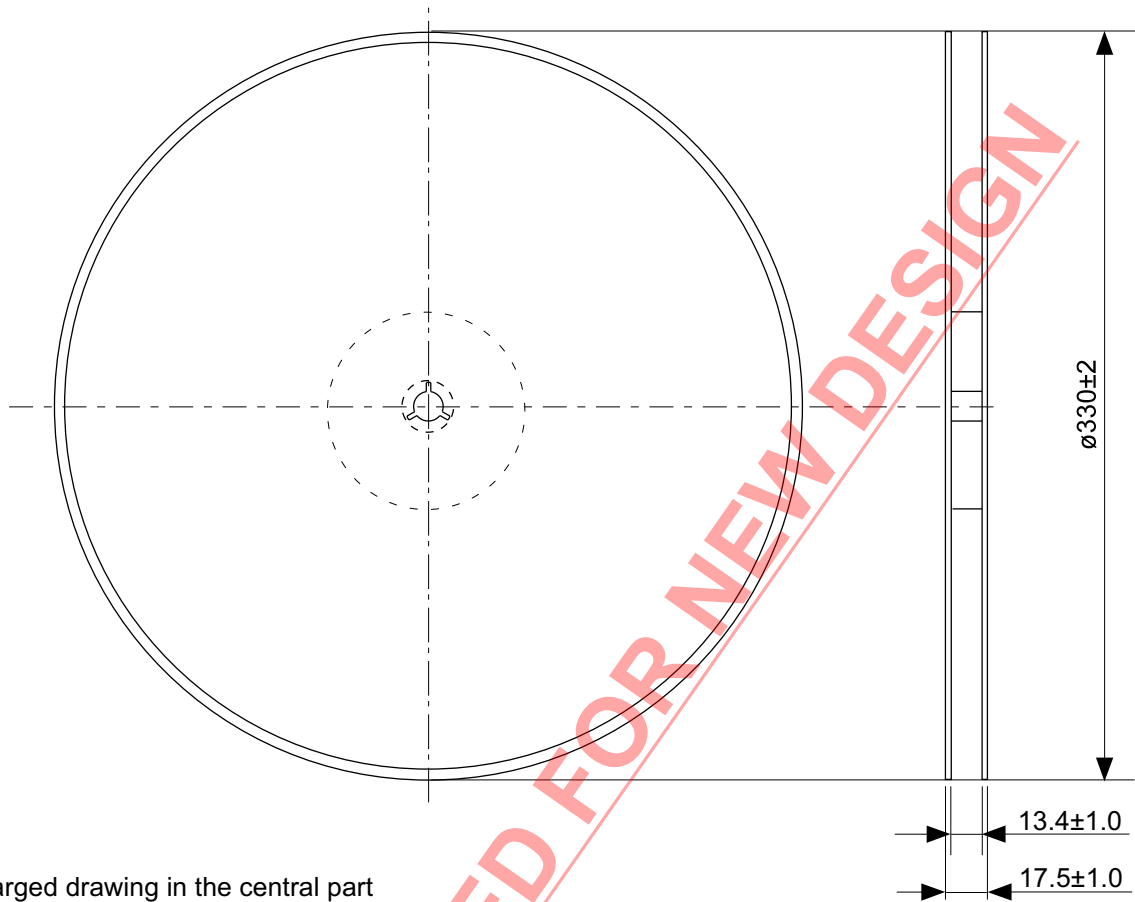

Enlarged drawing in the central part

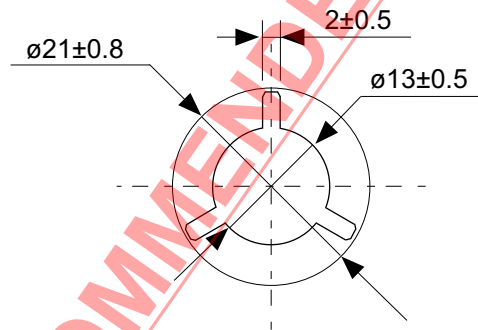

No. FT008-E-R-S1-1.0

TITLE	TSSOP8-E-Reel		
No.	FT008-E-R-S1-1.0		
ANGLE		QTY.	4,000
UNIT	mm		
<b>ABLIC Inc.</b>			

## Disclaimers (Handling Precautions)

1. All the information described herein (product data, specifications, figures, tables, programs, algorithms and application circuit examples, etc.) is current as of publishing date of this document and is subject to change without notice.
2. The circuit examples and the usages described herein are for reference only, and do not guarantee the success of any specific mass-production design.  
ABLIC Inc. is not responsible for damages caused by the reasons other than the products described herein (hereinafter "the products") or infringement of third-party intellectual property right and any other right due to the use of the information described herein.
3. ABLIC Inc. is not responsible for damages caused by the incorrect information described herein.
4. Be careful to use the products within their specified ranges. Pay special attention to the absolute maximum ratings, operation voltage range and electrical characteristics, etc.  
ABLIC Inc. is not responsible for damages caused by failures and / or accidents, etc. that occur due to the use of the products outside their specified ranges.
5. When using the products, confirm their applications, and the laws and regulations of the region or country where they are used and verify suitability, safety and other factors for the intended use.
6. When exporting the products, comply with the Foreign Exchange and Foreign Trade Act and all other export-related laws, and follow the required procedures.
7. The products must not be used or provided (exported) for the purposes of the development of weapons of mass destruction or military use. ABLIC Inc. is not responsible for any provision (export) to those whose purpose is to develop, manufacture, use or store nuclear, biological or chemical weapons, missiles, or other military use.
8. The products are not designed to be used as part of any device or equipment that may affect the human body, human life, or assets (such as medical equipment, disaster prevention systems, security systems, combustion control systems, infrastructure control systems, vehicle equipment, traffic systems, in-vehicle equipment, aviation equipment, aerospace equipment, and nuclear-related equipment), excluding when specified for in-vehicle use or other uses. Do not apply the products to the above listed devices and equipments without prior written permission by ABLIC Inc. Especially, the products cannot be used for life support devices, devices implanted in the human body and devices that directly affect human life, etc.  
Prior consultation with our sales office is required when considering the above uses.  
ABLIC Inc. is not responsible for damages caused by unauthorized or unspecified use of our products.
9. Semiconductor products may fail or malfunction with some probability.  
The user of the products should therefore take responsibility to give thorough consideration to safety design including redundancy, fire spread prevention measures, and malfunction prevention to prevent accidents causing injury or death, fires and social damage, etc. that may ensue from the products' failure or malfunction.  
The entire system must be sufficiently evaluated and applied on customer's own responsibility.
10. The products are not designed to be radiation-proof. The necessary radiation measures should be taken in the product design by the customer depending on the intended use.
11. The products do not affect human health under normal use. However, they contain chemical substances and heavy metals and should therefore not be put in the mouth. The fracture surfaces of wafers and chips may be sharp. Be careful when handling these with the bare hands to prevent injuries, etc.
12. When disposing of the products, comply with the laws and ordinances of the country or region where they are used.
13. The information described herein contains copyright information and know-how of ABLIC Inc.  
The information described herein does not convey any license under any intellectual property rights or any other rights belonging to ABLIC Inc. or a third party. Reproduction or copying of the information from this document or any part of this document described herein for the purpose of disclosing it to a third-party without the express permission of ABLIC Inc. is strictly prohibited.
14. For more details on the information described herein, contact our sales office.

2.0-2018.01