

THIS DRAWING CONTAINS INFORMATION PROPRIETARY TO RF INDUSTRIES,
 ANY UNAUTHORIZED USE OF THIS DRAWING IS EXPRESSLY PROHIBITED
 WITHOUT WRITTEN PERMISSION FROM RF INDUSTRIES.
 ANY VIOLATION IS PUNISHABLE UNDER U.S. COPYRIGHT LAWS.

ALL DIMENSIONS ARE REFERENCE ONLY

PART NO.		RFN-1027-B		
REV	DESCRIPTION	DWN	DATE	APPROVED
-	ENGINEERING RELEASE	CZS	5/13/03	JDMc
A	CHANGE DIMENSIONS THROUGHOUT	CZS	11/4/05	JDMc

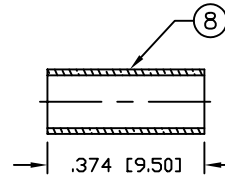
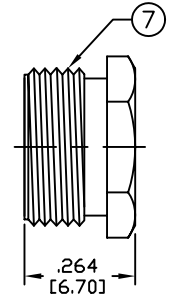
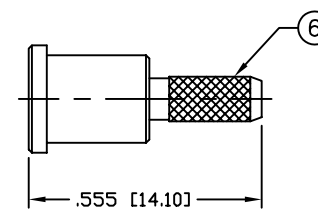
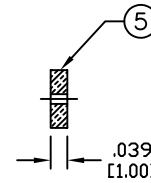
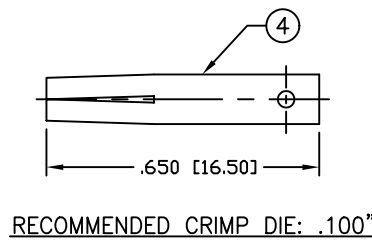
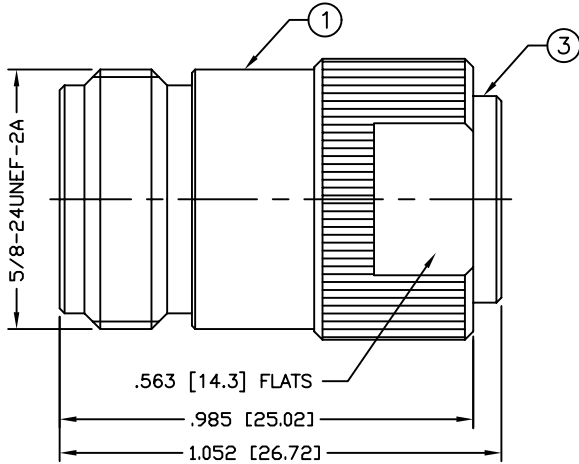

RECOMMENDED CRIMP DIE: .130"

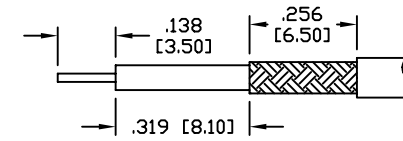

RECOMMENDED STRIPPING DIMENSIONS

SPECIFICATIONS:

IMPEDANCE: 50 Ohms
 FREQUENCY RANGE: 0-11 GHz
 VSWR: 1.3 Max. @ 9 GHz
 INSERTION LOSS: .06 dB Max. X fGHz
 WORKING VOLTAGE: 1k V rms @ $\sqrt{\text{sea}}$ level
 TEMPERATURE RANGE: -65°C TO 165°C
 INSULATION RESISTANCE: 5k M Ohms min.
 FOR RG-174, 188, 188A, 316/U, ALPHA 9174, 9316,
 BELDEN 8216, 83269, 83284, 84316 & TIMES LMR-100A CABLE

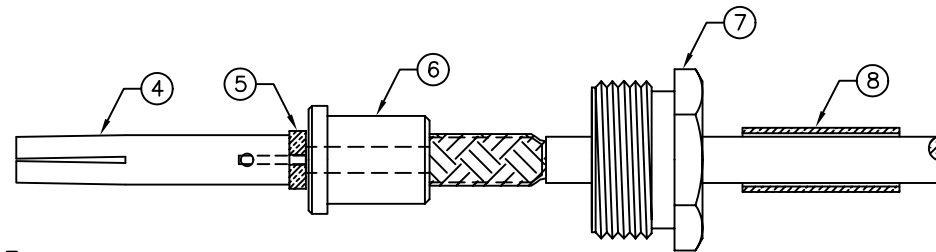

1	BODY	1	BRASS	NICKEL, 100 μ "	008974	
2	INSULATOR	1	PTFE	---		
3	INNER BODY	1	BRASS	NICKEL, 100 μ "		
4	CONTACT	1	PHOS. BRONZE	GOLD, 3 μ "		
5	INSULATOR	1	PTFE	---		
6	FERRULE STUD	1	BRASS	NICKEL, 100 μ "		
7	HEX NUT	1	BRASS	NICKEL, 100 μ "		
8	FERRULE	1	BRASS	NICKEL, 100 μ "		
9						
10					DRAWN	
11					C. ZUNIGA	
12					CHECKED	
13					11/4/05	
14					ORJ DRAWN	
					C. ZUNIGA	
					9/21/00	
#	DESCRIPTION	QTY	MATERIAL	FINISH	APPROVALS	DATE

UNLESS OTHERWISE SPECIFIED:

DIMENSIONS ARE IN INCHES
 AND [MILLIMETERS]
 UNLESS OTHERWISE NOTED
 TOLERANCES ARE:

DECIMALS DIAMETER

RF connectors
 DIVISION OF RF INDUSTRIES, LTD.
 7610 MIRAMAR RD
 SAN DIEGO, CA 92126
 (858) 549-6340
 (858) 549-6345 FAX

N JACK, CRIMP

SIZE	CABLE GROUP	DWG NO.	REV
A	B	RFN-1027-B	A
SCALE: NTS		CAD FILE OUTLINE	SHEET 1 OF 1