

IEC Appliance Inlet C14 with Filter, Line Switch 1- or 2-pole, Front or Rear Side Mounting



Screw-on mounting
from front side



Snap-in version
from front side



Screw-on mounting
from front side, protection class II



See below:
[Approvals and Compliances](#)

Description

- Panel mount :
Screw-on version from front or rear side, snap-in version front side
- 3 Functions :
Appliance Inlet protection class I or II , Line Switch 1- or 2-pole , Line filter in standard and medical version
- Quick connect terminals 6.3 x 0.8 mm

Unique Selling Proposition

- Compact power entry module
- Available in white or black
- Switch for high inrush current
- V-Lock cord retaining

Characteristics

- Compact design with optimal shielding
- Rear side mounting for efficient cost-saving assembly
- All single elements are already wired
- Line switch non-illuminated or illuminated
- Universal line filter for standard applications
- Ideal for application with high transient loads
- For applications according IEC/UL 62368-1 we recommend variants with bleed resistor
- Suitable for use in medical equipment according to IEC/UL 60601-1 (1 MOOP, 1 MOPP)

Other versions on request

- Solder terminals
- Other rocker marking
- Capacitance CX1

References

Alternative: version without line filter [DC11](#)
 Substitute for type [KFB1](#); [KFB2](#)

Weblinks

[pdf data sheet](#), [html datasheet](#), [General Product Information](#), [Approvals](#), [Distributor-Stock-Check](#), [Accessories](#), [Detailed request for product](#)

Newly available variants corresponding to V-Lock mating cordset. The connector is equipped with a notch intended for use with the latching cordset. The cord latching system prevents against accidental removal of the cordset.

Technical Data

| | | | |
|---------------------------------|---|-------------------------|--|
| Ratings IEC | 1 - 10A @ Ta 40 °C / 250VAC; 50Hz | Appliance inlet/-outlet | C14 / C18 acc. to IEC 60320-1, UL 498, CSA C22.2 no. 42 (for cold conditions) pin-temperature 70 °C, 10A, Protection Class I or II |
| Ratings UL/CSA | 1 - 10A @ Ta 40 °C / 250VAC; 60Hz | Line Switch | Rocker switch 1-/2-pole, non-illuminated or illuminated, acc. to IEC 61058-1 Technical Details |
| Leakage Current | standard < 0.5mA (250V / 60Hz) medical < 5 µA (250 V / 60 Hz) | Line Filter | Standard and Medical Version, IEC 60939, UL 60939-3, CSA C22.2 no. 8 Technical Details |
| Dielectric Strength | > 1.7kVDC between L-N > 2.7kVDC between L/N-PE Test voltage (2 sec) | MTBF | > 1'900'000h acc. to MIL-HB-217 F |
| Allowable Operation Temperature | -25 °C to 85 °C | | |
| Climatic Category | 25/085/21 acc. to IEC 60068-1 | | |
| IP-Protection | front side IP40 acc. to IEC 60529 | | |
| Protection Class | Suitable for appliances with protection class I or II acc. to IEC 61140 | | |
| Terminal | Quick connect terminals 6.3 x 0.8 mm | | |
| Panel Thickness S | Screw: max 8 mm Mounting screw torque max 0.5Nm Snap-in: 1 mm to 3 mm | | |
| Material | Thermoplastic, black / white, UL 94V-0 | | |

Approvals and Compliances



Detailed information on product approvals, code requirements, usage instructions and detailed test conditions can be looked up in [Details about Approvals](#)

SCHURTER products are designed for use in industrial environments. They have approvals from independent testing bodies according to national and international standards. Products with specific characteristics and requirements such as required in the automotive sector according to IATF 16949, medical technology according to ISO 13485 or in the aerospace industry can be offered exclusively with customer-specific, individual agreements by SCHURTER.

Approvals







The approval mark is used by the testing authorities to certify compliance with the safety requirements placed on electronic products.

Approval Reference Type: DC12

| Approval Logo | Certificates | Certification Body | Description |
|--|-------------------------------|--------------------|--|
|  | VDE Approvals | VDE | Certificate Number: 40001522 |
|  | UL Approvals | UL | UR File Number: E495089 |
|  | CQC Approvals | CQC | CQC Certificate Number: CQC18001188116 |



Product standards

Product standards that are referenced

| Organization | Design | Standard | Description |
|--|-----------------------|------------------|---|
|  | Designed according to | IEC 60320-1 | Appliance couplers for household and similar general purposes |
|  | Designed according to | IEC 60939 | Passive filters for suppressing electromagnetic interference |
|  | Designed according to | IEC 61058-1 | Switches for appliances. Part 1. General requirements |
|  | Designed according to | UL 498 | Standard for Attachment Plugs and Receptacles |
|  | Designed according to | UL 60939-3 | Passive filters for suppressing electromagnetic interference |
|  | Designed according to | CSA C22.2 no. 42 | General Use Receptacles, Attachment Plugs, and Similar Wiring Devices |
|  | Designed according to | CSA C22.2 no. 8 | Electromagnetic interference (EMI) filters |









Application standards

Application standards where the product can be used

| Organization | Design | Standard | Description |
|--|--------------------------------|----------------|--|
|  | Suitable for applications acc. | IEC/UL 62368-1 | Audio/video, information and communication technology equipment - Part 1: Safety requirements |
|  | Suitable for applications acc. | IEC 60601-1 | Medical electrical equipment - Part 1: General requirements for basic safety and essential performance |
|  | Suitable for applications acc. | IEC 60335-1 | Safety of electrical appliances for household and similar purposes. Meets the requirements for appliances in unattended use. This includes the enhanced requirements of glow wire tests acc. to IEC 60695-2-11 or -12 & -13. |

Compliances

The product complies with following Guide Lines

| Identification | Details | Initiator | Description |
|---|--|-------------|--|
|  | CE declaration of conformity | SCHURTER AG | The CE marking declares that the product complies with the applicable requirements laid down in the harmonisation of Community legislation on its affixing in accordance with EU Regulation 765/2008. |
|  | UKCA declaration of conformity | SCHURTER AG | The UKCA marking declares that the product complies with the applicable requirements laid down in the British Amendment of Regulation (EC) 765/2008. |
|  | RoHS | SCHURTER AG | Directive RoHS 2011/65/EU, Amendment (EU) 2015/863 |
|  | China RoHS | SCHURTER AG | The law SJ / T 11363-2006 (China RoHS) has been in force since 1 March 2007. It is similar to the EU directive RoHS. |
|  | REACH | SCHURTER AG | On 1 June 2007, Regulation (EC) No 1907/2006 on the Registration, Evaluation, Authorization and Restriction of Chemicals 1 (abbreviated as "REACH") entered into force. |
|  | | SCHURTER AG | V-Lock system are based on a matching plug-dose combination. The connector is equipped with a notch intended for use with the latching cordset. The cord latching system prevents against accidental removal of the cordset. |
|  | White Paper Glow wire test | SCHURTER AG | Meets the requirements of IEC 60335-1 for appliances in unattended use. This includes the enhanced requirements of glow wire tests acc. to IEC 60695-2-11 or -12 &-13. |
|  | Medical Equipment | SCHURTER AG | Suitable for use in medical equipment according to IEC/UL 60601-1 (1 MOOP, 1 MOPP) |

Dimension [mm]

Screw-on mounting from front side

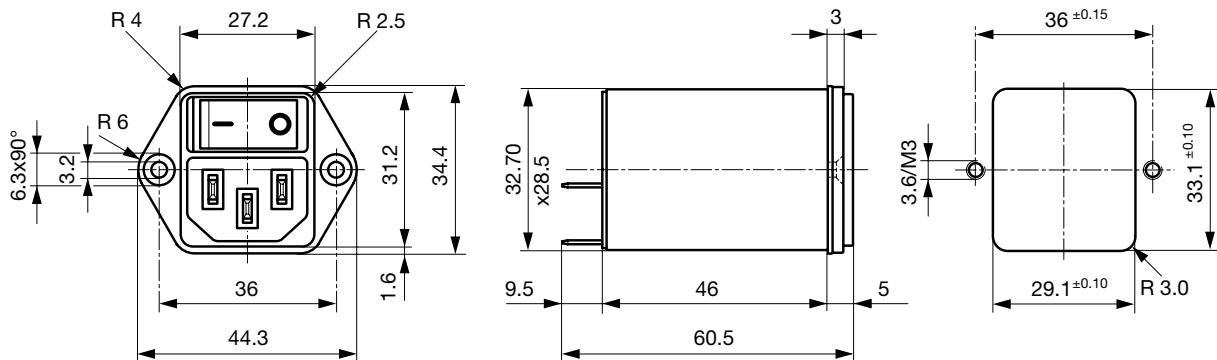

Screw-on mounting from rear side (metal flange)

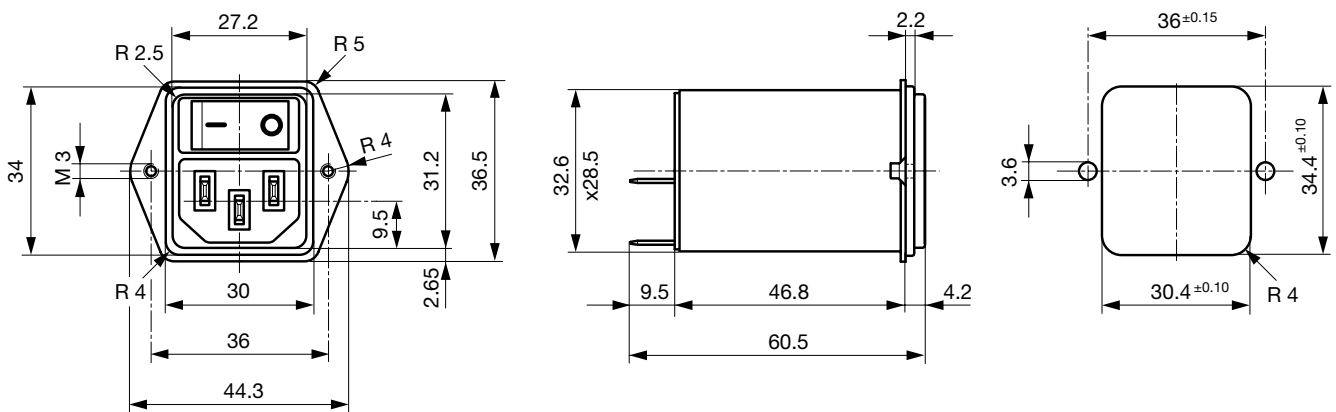

Snap-in mounting from front side

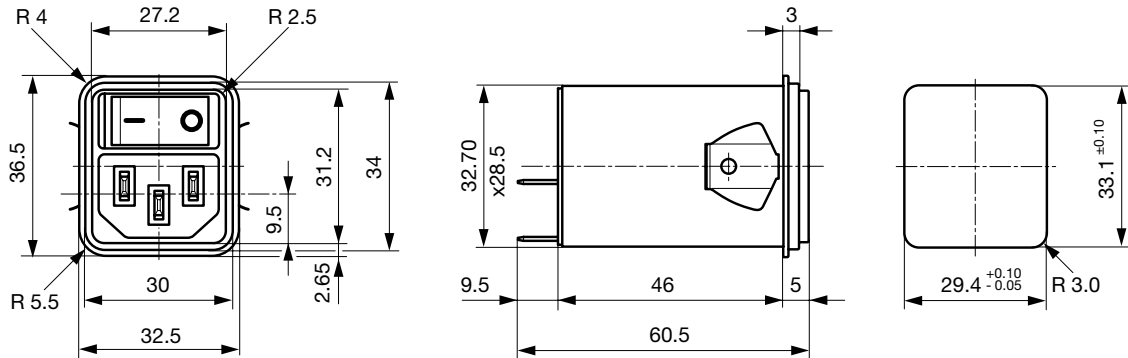

Screw-on mounting from front side (protection class II)

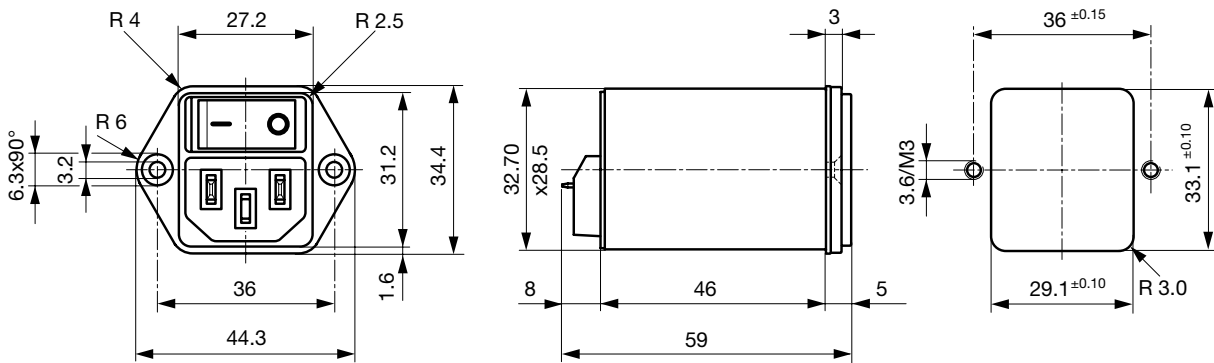

Screw-on mounting from rearside (protection class II)

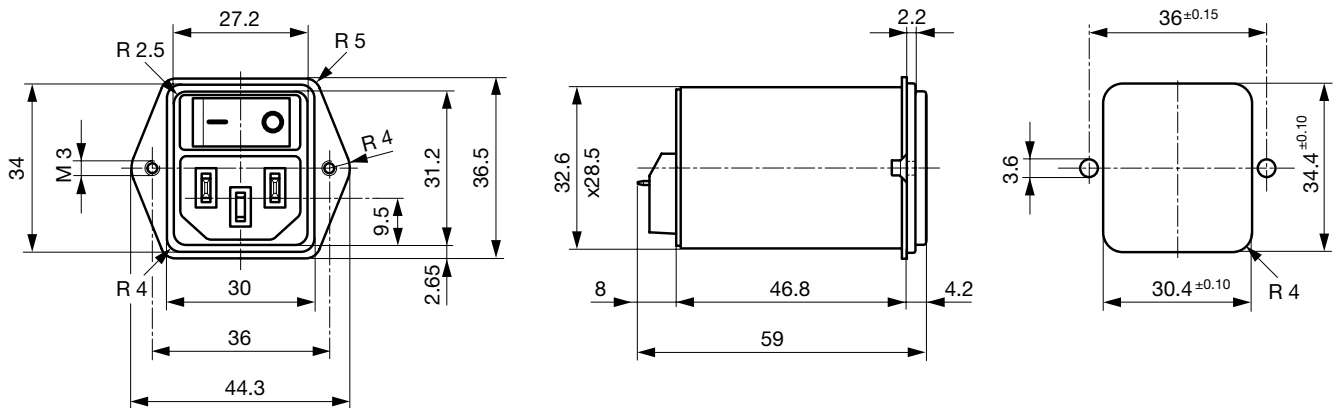

Snap-in mounting from front side (protection class II)

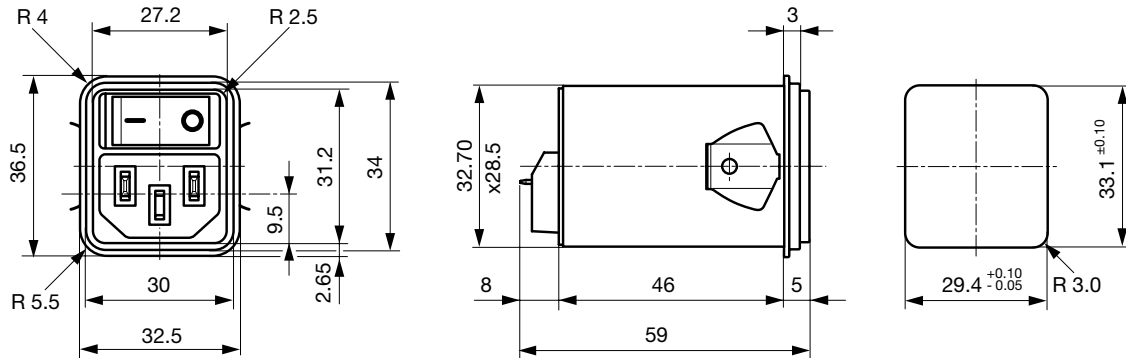

Technical Data of Filter-Components

| Rated Current [A] | Filter-Type | Inductances L [mH] | Capacitance CX [nF] | Capacitance CY [nF] | R [mΩ] |
|-------------------|-----------------------|--------------------|---------------------|---------------------|--------|
| 1 | Standard version | 2 x 10 | 100 | 2.2 | 1 |
| 2 | Standard version | 2 x 4 | 100 | 2.2 | 1 |
| 4 | Standard version | 2 x 1.5 | 100 | 2.2 | 1 |
| 6 | Standard version | 2 x 0.8 | 100 | 2.2 | 1 |
| 10 | Standard version | 2 x 0.3 | 100 | 2.2 | 1 |
| 1 | Medical Version (M5) | 2 x 10 | 100 | - | 1 |
| 2 | Medical Version (M5) | 2 x 4 | 100 | - | 1 |
| 4 | Medical Version (M5) | 2 x 1.5 | 100 | - | 1 |
| 6 | Medical Version (M5) | 2 x 0.8 | 100 | - | 1 |
| 10 | Medical Version (M5) | 2 x 0.3 | 100 | - | 1 |
| 1 | Medical Version (M80) | 2 x 10 | 100 | 0.47 | 1 |
| 2 | Medical Version (M80) | 2 x 4 | 100 | 0.47 | 1 |
| 4 | Medical Version (M80) | 2 x 1.5 | 100 | 0.47 | 1 |
| 6 | Medical Version (M80) | 2 x 0.8 | 100 | 0.47 | 1 |
| 10 | Medical Version (M80) | 2 x 0.3 | 100 | 0.47 | 1 |

Diagrams

Standard filter 1-pole



1) Line
 2) Load

Standard filter 2-pole



1) Line
 2) Load

Medical filter 1-pole (M5)



1) Line
 2) Load

Medical Version (M5)
 2-pole



1) Line
 2) Load

Standard filter 2-pole illuminated

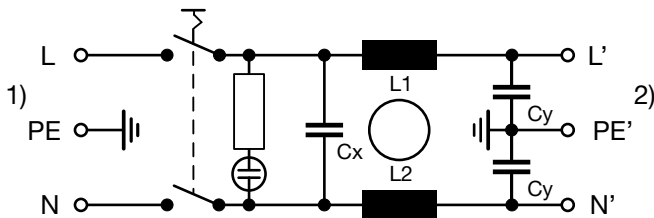

1) Line
 2) Load

Medical Filter 2-pole (M5)
 illuminated

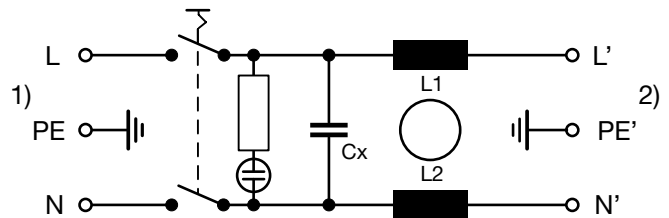

1) Line
 2) Load

Medical filter 2-pole (M5) protection class II



1) Line
 2) Load

Attenuation Loss

--- 50Ω differential mode ____ 50Ω common mode

Standard version

1 A

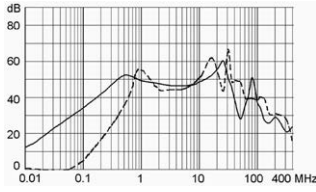

2 A

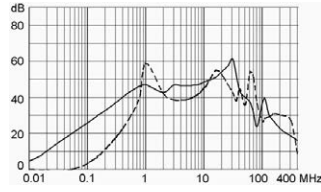

4 A

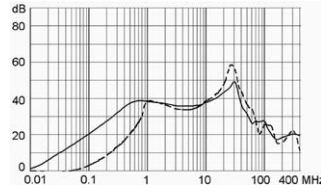

6 A

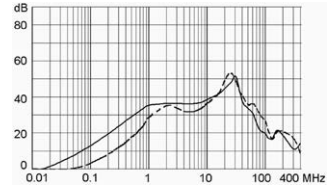

10 A

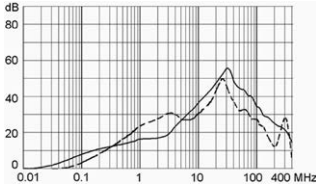

Medical version (M5)

1 A

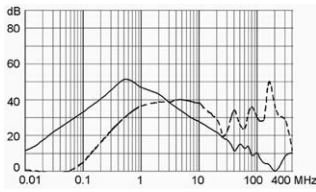

2 A

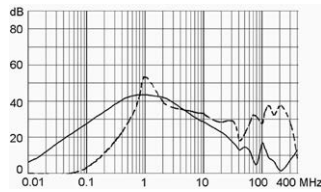

4 A

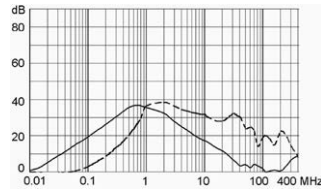

6 A

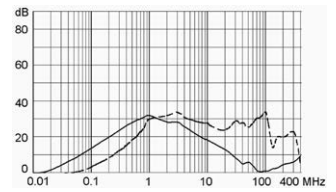

10 A

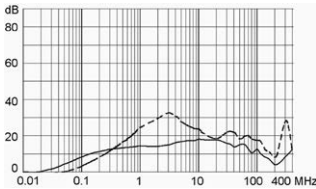

All Variants

| Rated current | Filter-Type | Panel mounting | Mounting side | Line Switch | Illumination | Color | Pro-tection | V-Lock | Order Number |
|---------------|------------------|----------------|---------------|-------------|-----------------|-------|-------------|--------|---------------|
| 1 | Standard version | Snap-in | Front Side | 1-pole | non-illuminated | black | I | ● | DC12.1102.103 |
| 2 | Standard version | Snap-in | Front Side | 1-pole | non-illuminated | black | I | ● | DC12.2102.103 |
| 4 | Standard version | Snap-in | Front Side | 1-pole | non-illuminated | black | I | ● | DC12.3102.103 |
| 6 | Standard version | Snap-in | Front Side | 1-pole | non-illuminated | black | I | ● | DC12.4102.103 |
| 10 | Standard version | Snap-in | Front Side | 1-pole | non-illuminated | black | I | ● | DC12.5102.103 |
| 1 | Standard version | Snap-in | Front Side | 2-pole | non-illuminated | black | I | ● | DC12.1102.101 |
| 2 | Standard version | Snap-in | Front Side | 2-pole | non-illuminated | black | I | ● | DC12.2102.101 |
| 4 | Standard version | Snap-in | Front Side | 2-pole | non-illuminated | black | I | ● | DC12.3102.101 |
| 6 | Standard version | Snap-in | Front Side | 2-pole | non-illuminated | black | I | ● | DC12.4102.101 |
| 10 | Standard version | Snap-in | Front Side | 2-pole | non-illuminated | black | I | ● | DC12.5102.101 |
| 1 | Standard version | Screw | Rear Side | 1-pole | non-illuminated | black | I | ● | DC12.1102.203 |
| 2 | Standard version | Screw | Rear Side | 1-pole | non-illuminated | black | I | ● | DC12.2102.203 |
| 4 | Standard version | Screw | Rear Side | 1-pole | non-illuminated | black | I | ● | DC12.3102.203 |

| Rated current | Filter-Type | Panel mounting | Mounting side | Line Switch | Illumination | Color | Pro-tection | V-Lock | Order Number |
|---------------|----------------------|----------------|---------------|-------------|-------------------|-------|-------------|--------|---------------|
| 6 | Standard version | Screw | Rear Side | 1-pole | non-illuminated | black | I | ● | DC12.4102.203 |
| 10 | Standard version | Screw | Rear Side | 1-pole | non-illuminated | black | I | ● | DC12.5102.203 |
| 1 | Standard version | Screw | Rear Side | 2-pole | non-illuminated | black | I | ● | DC12.1102.201 |
| 2 | Standard version | Screw | Rear Side | 2-pole | non-illuminated | black | I | ● | DC12.2102.201 |
| 4 | Standard version | Screw | Rear Side | 2-pole | non-illuminated | black | I | ● | DC12.3102.201 |
| 6 | Standard version | Screw | Rear Side | 2-pole | non-illuminated | black | I | ● | DC12.4102.201 |
| 10 | Standard version | Screw | Rear Side | 2-pole | non-illuminated | black | I | ● | DC12.5102.201 |
| 1 | Standard version | Screw | Front Side | 1-pole | non-illuminated | black | I | ● | DC12.1102.003 |
| 2 | Standard version | Screw | Front Side | 1-pole | non-illuminated | black | I | ● | DC12.2102.003 |
| 4 | Standard version | Screw | Front Side | 1-pole | non-illuminated | black | I | ● | DC12.3102.003 |
| 6 | Standard version | Screw | Front Side | 1-pole | non-illuminated | black | I | ● | DC12.4102.003 |
| 10 | Standard version | Screw | Front Side | 1-pole | non-illuminated | black | I | ● | DC12.5102.003 |
| 1 | Standard version | Screw | Front Side | 2-pole | non-illuminated | black | I | ● | DC12.1102.001 |
| 2 | Standard version | Screw | Front Side | 2-pole | non-illuminated | black | I | ● | DC12.2102.001 |
| 4 | Standard version | Screw | Front Side | 2-pole | non-illuminated | black | I | ● | DC12.3102.001 |
| 6 | Standard version | Screw | Front Side | 2-pole | non-illuminated | black | I | ● | DC12.4102.001 |
| 10 | Standard version | Screw | Front Side | 2-pole | non-illuminated | black | I | ● | DC12.5102.001 |
| 1 | Medical Version (M5) | Snap-in | Front Side | 1-pole | non-illuminated | black | I | ● | DC12.1202.103 |
| 2 | Medical Version (M5) | Snap-in | Front Side | 1-pole | non-illuminated | black | I | ● | DC12.2202.103 |
| 4 | Medical Version (M5) | Snap-in | Front Side | 1-pole | non-illuminated | black | I | ● | DC12.3202.103 |
| 6 | Medical Version (M5) | Snap-in | Front Side | 1-pole | non-illuminated | black | I | ● | DC12.4202.103 |
| 10 | Medical Version (M5) | Snap-in | Front Side | 1-pole | non-illuminated | black | I | ● | DC12.5202.103 |
| 6 | Medical Version (M5) | Snap-in | Front Side | 2-pole | illuminated green | black | I | ● | DC12.4232.101 |
| 1 | Medical Version (M5) | Snap-in | Front Side | 2-pole | non-illuminated | black | I | ● | DC12.1202.101 |
| 1 | Medical Version (M5) | Snap-in | Front Side | 2-pole | non-illuminated | black | II | ● | DC12.1202.121 |
| 1 | Medical Version (M5) | Snap-in | Front Side | 2-pole | non-illuminated | white | II | ● | DC12.1202.131 |
| 2 | Medical Version (M5) | Snap-in | Front Side | 2-pole | non-illuminated | black | I | ● | DC12.2202.101 |
| 2 | Medical Version (M5) | Snap-in | Front Side | 2-pole | non-illuminated | black | II | ● | DC12.2202.121 |
| 2 | Medical Version (M5) | Snap-in | Front Side | 2-pole | non-illuminated | white | II | ● | DC12.2202.131 |
| 4 | Medical Version (M5) | Snap-in | Front Side | 2-pole | non-illuminated | black | I | ● | DC12.3202.101 |
| 4 | Medical Version (M5) | Snap-in | Front Side | 2-pole | non-illuminated | black | II | ● | DC12.3202.121 |
| 4 | Medical Version (M5) | Snap-in | Front Side | 2-pole | non-illuminated | white | II | ● | DC12.3202.131 |
| 6 | Medical Version (M5) | Snap-in | Front Side | 2-pole | non-illuminated | black | I | ● | DC12.4202.101 |
| 6 | Medical Version (M5) | Snap-in | Front Side | 2-pole | non-illuminated | black | II | ● | DC12.4202.121 |
| 6 | Medical Version (M5) | Snap-in | Front Side | 2-pole | non-illuminated | white | II | ● | DC12.4202.131 |
| 10 | Medical Version (M5) | Snap-in | Front Side | 2-pole | non-illuminated | black | I | ● | DC12.5202.101 |
| 10 | Medical Version (M5) | Snap-in | Front Side | 2-pole | non-illuminated | black | II | ● | DC12.5202.121 |
| 10 | Medical Version (M5) | Snap-in | Front Side | 2-pole | non-illuminated | white | II | ● | DC12.5202.131 |
| 1 | Medical Version (M5) | Screw | Rear Side | 2-pole | non-illuminated | black | I | ● | DC12.1202.201 |
| 2 | Medical Version (M5) | Screw | Rear Side | 2-pole | non-illuminated | black | I | ● | DC12.2202.201 |
| 4 | Medical Version (M5) | Screw | Rear Side | 2-pole | non-illuminated | black | I | ● | DC12.3202.201 |
| 6 | Medical Version (M5) | Screw | Rear Side | 2-pole | non-illuminated | black | I | ● | DC12.4202.201 |
| 10 | Medical Version (M5) | Screw | Rear Side | 2-pole | non-illuminated | black | I | ● | DC12.5202.201 |
| 1 | Medical Version (M5) | Screw | Front Side | 1-pole | non-illuminated | black | I | ● | DC12.1202.003 |
| 2 | Medical Version (M5) | Screw | Front Side | 1-pole | non-illuminated | black | I | ● | DC12.2202.003 |
| 4 | Medical Version (M5) | Screw | Front Side | 1-pole | non-illuminated | black | I | ● | DC12.3202.003 |
| 6 | Medical Version (M5) | Screw | Front Side | 1-pole | non-illuminated | black | I | ● | DC12.4202.003 |

| Rated current | Filter-Type | Panel mounting | Mounting side | Line Switch | Illumination | Color | Pro-tection | V-Lock | Order Number |
|---------------|-----------------------|----------------|---------------|-------------|-----------------|-------|-------------|--------|---------------|
| 10 | Medical Version (M5) | Screw | Front Side | 1-pole | non-illuminated | black | I | ● | DC12.5202.003 |
| 1 | Medical Version (M5) | Screw | Front Side | 2-pole | non-illuminated | black | I | ● | DC12.1202.001 |
| 1 | Medical Version (M5) | Screw | Front Side | 2-pole | non-illuminated | black | II | ● | DC12.1202.021 |
| 1 | Medical Version (M5) | Screw | Front Side | 2-pole | non-illuminated | white | II | ● | DC12.1202.031 |
| 2 | Medical Version (M5) | Screw | Front Side | 2-pole | non-illuminated | black | I | ● | DC12.2202.001 |
| 2 | Medical Version (M5) | Screw | Front Side | 2-pole | non-illuminated | black | II | ● | DC12.2202.021 |
| 2 | Medical Version (M5) | Screw | Front Side | 2-pole | non-illuminated | white | II | ● | DC12.2202.031 |
| 4 | Medical Version (M5) | Screw | Front Side | 2-pole | non-illuminated | black | I | ● | DC12.3202.001 |
| 4 | Medical Version (M5) | Screw | Front Side | 2-pole | non-illuminated | black | II | ● | DC12.3202.021 |
| 4 | Medical Version (M5) | Screw | Front Side | 2-pole | non-illuminated | white | II | ● | DC12.3202.031 |
| 6 | Medical Version (M5) | Screw | Front Side | 2-pole | non-illuminated | black | I | ● | DC12.4202.001 |
| 6 | Medical Version (M5) | Screw | Front Side | 2-pole | non-illuminated | black | II | ● | DC12.4202.021 |
| 6 | Medical Version (M5) | Screw | Front Side | 2-pole | non-illuminated | white | II | ● | DC12.4202.031 |
| 10 | Medical Version (M5) | Screw | Front Side | 2-pole | non-illuminated | black | I | ● | DC12.5202.001 |
| 10 | Medical Version (M5) | Screw | Front Side | 2-pole | non-illuminated | black | II | ● | DC12.5202.021 |
| 10 | Medical Version (M5) | Screw | Front Side | 2-pole | non-illuminated | white | II | ● | DC12.5202.031 |
| 1 | Medical Version (M80) | Screw | Rear Side | 2-pole | non-illuminated | black | I | ● | DC12.1602.201 |
| 2 | Medical Version (M80) | Screw | Rear Side | 2-pole | non-illuminated | black | I | ● | DC12.2602.201 |
| 4 | Medical Version (M80) | Screw | Rear Side | 2-pole | non-illuminated | black | I | ● | DC12.3602.201 |
| 6 | Medical Version (M80) | Screw | Rear Side | 2-pole | non-illuminated | black | I | ● | DC12.4602.201 |
| 10 | Medical Version (M80) | Screw | Rear Side | 2-pole | non-illuminated | black | I | ● | DC12.5602.201 |

Most Popular.

Availability for all products can be searched real-time: <https://www.schurter.com/en/Stock-Check/Stock-Check-SCHURTER>

Packaging unit 10 Pcs

Accessories

Description



Wire_Harness
 Wire harness for SCHURTER products



RC320
 Rear Cover for Power Entry Module



[Cord_retaining_kits](#)
 Cord retaining strain relief

| | |
|----------------|-----------|
| Flat head, A | 4700.0001 |
| Countersunk, B | 4700.0002 |

Mating Outlets/Connectors

Category / Description

[Connector Overview complete](#)



| | |
|---|---------|
| 4782 Mounting: Power Cord, 3 x 1 mm ² / 3 x 18 AWG, Cable, Connector: IEC C13 | 4782 |
| 4785 Mounting: Power Cord, 3 x 1 mm ² / 3 x 18 AWG, Cable, Connector: IEC C13 | 4785 |
| 4300-06 Mounting: Power Cord, 3 x 1 mm ² / 3 x 18 AWG, Cable, Connector: IEC C13 | 4300-06 |
| 4781 Mounting: Power Cord, Cable, Connector: IEC C15 | 4781 |
| 4784 Mounting: Power Cord, 3 x 1 mm ² / 3 x 18 AWG, Cable, Connector: IEC C15 | 4784 |

[Interconnection Cord Overview complete](#)



| | |
|--|-----------|
| Cord Sets 10 A, Interconnection, 1.0 m, Connector IEC C13, H05VV-F3G1.0, black | 6007.0212 |
| Cord Sets 10 A, Interconnection, 2.0 m, Connector IEC C13, H05VV-F3G1.0, black | 6007.0214 |

[Power Supply Cord Overview complete](#)



| | |
|--|-----------|
| Cord Sets 10 A, Europlug, 2.0 m, Connector IEC C13, H05VV-F3G0.75, black | 6004.0114 |
| Cord Sets 10 A, Europlug, 2.5 m, Connector IEC C13, H05VV-F3G1.0, black | 6004.0215 |
| Cord Sets 10 A, Europlug, 2.5 m, Connector IEC C13, H05VV-F3G1.0, black | 6003.0215 |
| Cord Sets 10 A, Europlug, Black, 2.5 m, H05VV-F 3G1,0mm2, Connector IEC C13, H05VV-F3G1.0, black | 6004.0225 |
| Cord Sets 10 A, diverse, Black, 5.0 m, H05VV-F 3G1,0mm2, Connector IEC C13, H05VV-F3G1.0, black | 6052.0026 |

...

Mating Outlets/Connectors shuttered



[Connector Overview complete](#)

| | |
|--|------|
| 4783 Mounting: Power Cord, 3 x 1 mm ² / 3 x 18 AWG, Cable, Connector: IEC C13 | 4783 |
|--|------|

[Power Cord Overview complete](#)



| | |
|---|---------|
| VAC13KS, Overview, V-Lock cord retaining, diverse Connector IEC C13, diverse, black | VAC13KS |
| VAC17KS, V-Lock cord retaining, diverse m, Connector IEC C17, diverse, black / grey / white | VAC17KS |