



Bridgelux® Gen 8 Vero® SE 18 Array

Product Data Sheet DS432



Introduction

Vero SE



The Vero® SE Series is a revolutionary light source system that integrates Bridgelux's eighth generation COB technology with poke-in connectivity, enabling solder-free installation. Vero SE LED light sources streamline assembly processes, lower manufacturing costs, simplify the luminaire design process, improve light quality, and increase design flexibility.

Vero SE is available in four different light emitting surface (LES) configurations that operate reliably over a broad current range. With Vero SE, secondary connector and holder components are not required, allowing for rapid integration of arrays into fixtures, and an efficient field replaceable solution. Vero SE arrays deliver increased lumen density for improved beam control and precision lighting, with 2 and 3 SDCM color control standards for clean and consistent uniform lighting.

Features

- Poke-in electrical connectivity
- Top side part number markings
- Efficacy of 177 lm/W typical, 3000K 80 CRI
- Reliable operation at up to 3x nominal current, 30% increase in maximum lumens per LES size
- Wide selection of CCT options (2700K-6500K) with minimum 70, 80 and 90 CRI options
- Uniform high-quality illumination
- 2 and 3 SDCM binning options (2700K – 4000K)
- Forward voltage bin codes (backside marking)
- 10-Year warranty

Benefits

- Low cost, solderless, connector free installation and field upgradability
- Improved inventory management and quality control
- Enables high efficiency lighting systems and lower operating costs
- Supports the trend toward luminaire miniaturization and delivers enhanced optical control
- Design flexibility for a broad range of lighting applications
- Clean white light without pixelation
- Uniform consistent white light
- Design flexibility for multi-source applications
- Design with confidence

Contents

Product Feature Map	2
Product Nomenclature	2
Product Selection Guide	3
Performance at Commonly Used Drive Currents	7
Electrical Characteristics	16
Eye Safety	17
Absolute Maximum Ratings	18
Performance Curves	19
Typical Radiation Pattern	21
Typical Color Spectrum	22
Mechanical Dimensions	23
Color Binning Information	24
Packaging and Labeling	25
Design Resources	27
Precautions	27
Disclaimers	27
About Bridgelux	28

Product Selection Guide

The following product configurations are available:

Table 1: Selection Guide, Pulsed Measurement Data ($T_j = T_c = 25^\circ\text{C}$)

Part Number	Nominal CCT ¹ (K)	CRI ²	Nominal Drive Current ³ (mA)	Typical Pulsed Flux ^{4,5,6} $T_c = 25^\circ\text{C}$ (lm)	Minimum Pulsed Flux ^{6,7} $T_c = 25^\circ\text{C}$ (lm)	Typical V_f (V)	Typical Power (W)	Typical Efficacy (lm/W)
BXRC-27E4000-B-8x-SE	2700	80	700	3976	3578	33.9	23.7	168
BXRC-27E4000-C-8x-SE	2700	80	1050	5945	5351	33.9	35.6	167
BXRC-27E4000-D-8x-SE	2700	80	850	4002	3602	28.2	24.0	167
BXRC-27G4000-B-8x-SE	2700	90	700	3280	2952	33.9	23.7	138
BXRC-27G4000-C-8x-SE	2700	90	1050	4905	4414	33.9	35.6	138
BXRC-27G4000-D-8x-SE	2700	90	850	3302	2971	28.2	24.0	138
BXRC-27G40H0-B-8x-SE	2700	90	700	3422	3080	33.9	23.7	144
BXRC-27G40H0-C-8x-SE	2700	90	1050	5117	4605	33.9	35.6	144
BXRC-27G40H0-D-8x-SE	2700	90	850	3444	3100	28.2	24.0	144
BXRC-30C4001-B-8x-SE	3000	70	700	4423	3981	33.9	23.7	186
BXRC-30C4001-C-8x-SE	3000	70	1050	6614	5953	33.9	35.6	186
BXRC-30C4001-D-8x-SE	3000	70	850	4452	4007	28.2	24.0	186
BXRC-30E4000-B-8x-SE	3000	80	700	4224	3802	33.9	23.7	178
BXRC-30E4000-C-8x-SE	3000	80	1050	6317	5685	33.9	35.6	177
BXRC-30E4000-D-8x-SE	3000	80	850	4252	3827	28.2	24.0	177
BXRC-30G4000-B-8x-SE	3000	90	700	3429	3086	33.9	23.7	145
BXRC-30G4000-C-8x-SE	3000	90	1050	5128	4615	33.9	35.6	144
BXRC-30G4000-D-8x-SE	3000	90	850	3452	3106	28.2	24.0	144
BXRC-30G40H0-B-8x-SE	3000	90	700	3591	3232	33.9	23.7	151
BXRC-30G40H0-C-8x-SE	3000	90	1050	5369	4832	33.9	35.6	151
BXRC-30G40H0-D-8x-SE	3000	90	850	3614	3253	28.2	24.0	151
BXRC-35E4000-B-8x-SE	3500	80	700	4324	3891	33.9	23.7	182
BXRC-35E4000-C-8x-SE	3500	80	1050	6465	5819	33.9	35.6	182
BXRC-35E4000-D-8x-SE	3500	80	850	4352	3917	28.2	24.0	182
BXRC-35G4000-B-8x-SE	3500	90	700	3553	3198	33.9	23.7	150
BXRC-35G4000-C-8x-SE	3500	90	1050	5314	4782	33.9	35.6	149
BXRC-35G4000-D-8x-SE	3500	90	850	3577	3219	28.2	24.0	149
BXRC-40C4001-B-8x-SE	4000	70	700	4547	4093	33.9	23.7	192
BXRC-40C4001-C-8x-SE	4000	70	1050	6800	6120	33.9	35.6	191
BXRC-40C4001-D-8x-SE	4000	70	850	4577	4119	28.2	24.0	191
BXRC-40E4000-B-8x-SE	4000	80	700	4349	3914	33.9	23.7	183
BXRC-40E4000-C-8x-SE	4000	80	1050	6503	5852	33.9	35.6	183
BXRC-40E4000-D-8x-SE	4000	80	850	4377	3939	28.2	24.0	183
BXRC-40G4000-B-8x-SE	4000	90	700	3628	3265	33.9	23.7	153
BXRC-40G4000-C-8x-SE	4000	90	1050	5425	4883	33.9	35.6	152
BXRC-40G4000-D-8x-SE	4000	90	850	3652	3287	28.2	24.0	152

Notes for Table 1:

- Nominal CCT as defined by ANSI C78.377-2011. Products with a CCT of 5000K-6500K are hot targeted to $T_c = 85^\circ\text{C}$.
- CRI values are minimums for all products. Minimum R_g value for 80 CRI products is 0, the minimum R_g value for 90 CRI products is 50. Bridgelux maintains a ± 3 tolerance on CRI and R_g values.
- Drive current is referred to as nominal drive current.
- Products tested under pulsed condition (10ms pulse width) at nominal test current where T_j (junction temperature) - T_c (case temperature) = 25°C .
- Typical performance values are provided as a reference only and are not a guarantee of performance.
- Bridgelux maintains a $\pm 7\%$ tolerance on flux measurements.
- Minimum flux values at the nominal test current are guaranteed by 100% test.

Product Selection Guide

Table 1: Selection Guide, Pulsed Measurement Data ($T_j = T_c = 25^\circ\text{C}$) (continued)

Part Number	Nominal CCT ¹ (K)	CRI ²	Nominal Drive Current ³ (mA)	Typical Pulsed Flux ^{4,5,6} $T_c = 25^\circ\text{C}$ (lm)	Minimum Pulsed Flux ^{6,7} $T_c = 25^\circ\text{C}$ (lm)	Typical V_f (V)	Typical Power (W)	Typical Efficacy (lm/W)
BXRC-50C4001-B-8x-SE	5000	70	700	4572	4115	33.9	23.7	193
BXRC-50C4001-C-8x-SE	5000	70	1050	6837	6153	33.9	35.6	192
BXRC-50C4001-D-8x-SE	5000	70	850	4602	4142	28.2	24.0	192
BXRC-50E4001-B-8x-SE	5000	80	700	4398	3958	33.9	23.7	185
BXRC-50E4001-C-8x-SE	5000	80	1050	6577	5919	33.9	35.6	185
BXRC-50E4001-D-8x-SE	5000	80	850	4427	3984	28.2	24.0	185
BXRC-50G4001-B-8x-SE	5000	90	700	3802	3422	33.9	23.7	160
BXRC-50G4001-C-8x-SE	5000	90	1050	5685	5117	33.9	35.6	160
BXRC-50G4001-D-8x-SE	5000	90	850	3827	3444	28.2	24.0	160
BXRC-57C4001-B-8x-SE	5700	70	700	4448	4003	33.9	23.7	187
BXRC-57C4001-C-8x-SE	5700	70	1050	6651	5986	33.9	35.6	187
BXRC-57C4001-D-8x-SE	5700	70	850	4477	4029	28.2	24.0	187
BXRC-57E4001-B-8x-SE	5700	80	700	4224	3802	33.9	23.7	178
BXRC-57E4001-C-8x-SE	5700	80	1050	6317	5685	33.9	35.6	177
BXRC-57E4001-D-8x-SE	5700	80	850	4252	3827	28.2	24.0	177
BXRC-65C4001-B-8x-SE	6500	70	700	4448	4003	33.9	23.7	187
BXRC-65C4001-C-8x-SE	6500	70	1050	6651	5986	33.9	35.6	187
BXRC-65C4001-D-8x-SE	6500	70	850	4477	4029	28.2	24.0	187
BXRC-65E4001-B-8x-SE	6500	80	700	4274	3847	33.9	23.7	180
BXRC-65E4001-C-8x-SE	6500	80	1050	6391	5752	33.9	35.6	180
BXRC-65E4001-D-8x-SE	6500	80	850	4302	3872	28.2	24.0	179

Notes for Table 1:

1. Nominal CCT as defined by ANSI C78.377-2011. Products with a CCT of 5000K-6500K are hot targeted to $T_c = 85^\circ\text{C}$.
2. CRI values are minimums for all products. Minimum R9 value for 80 CRI products is 0, the minimum R9 value for 90 CRI products is 50. Bridgelux maintains a ± 3 tolerance for all CRI and R9 values.
3. Drive current is referred to as nominal drive current.
4. Products tested under pulsed condition (10ms pulse width) at nominal test current where T_j (junction temperature) - T_c (case temperature) = 25°C .
5. Typical performance values are provided as a reference only and are not a guarantee of performance.
6. Bridgelux maintains a $\pm 7\%$ tolerance on flux measurements.
7. Minimum flux values at the nominal test current are guaranteed by 100% test.

Product Selection Guide

Table 2: Selection Guide, Stabilized DC Performance ($T_c = 85^\circ\text{C}$)^{4,5}

Part Number	Nominal CCT ¹ (K)	CRI ²	Nominal Drive Current ³ (mA)	Typical DC Flux ^{4,5} $T_c = 85^\circ\text{C}$ (lm)	Minimum DC Flux ⁶ $T_c = 85^\circ\text{C}$ (lm)	Typical V_f (V)	Typical Power (W)	Typical Efficacy (lm/W)
BXRC-27E4000-B-8x-SE	2700	80	700	3578	3220	33.1	23.2	154
BXRC-27E4000-C-8x-SE	2700	80	1050	5351	4816	33.1	34.8	154
BXRC-27E4000-D-8x-SE	2700	80	850	3602	3242	27.7	23.5	153
BXRC-27G4000-B-8x-SE	2700	90	700	2952	2657	33.1	23.2	127
BXRC-27G4000-C-8x-SE	2700	90	1050	4414	3973	33.1	34.8	127
BXRC-27G4000-D-8x-SE	2700	90	850	2971	2674	27.7	23.5	126
BXRC-27G40H0-B-8x-SE	2700	90	700	3080	2772	33.1	23.2	133
BXRC-27G40H0-C-8x-SE	2700	90	1050	4605	4144	33.1	34.8	132
BXRC-27G40H0-D-8x-SE	2700	90	850	3100	2790	27.7	23.5	132
BXRC-30C4001-B-8x-SE	3000	70	700	3981	3583	33.1	23.2	172
BXRC-30C4001-C-8x-SE	3000	70	1050	5953	5357	33.1	34.8	171
BXRC-30C4001-D-8x-SE	3000	70	850	4007	3606	27.7	23.5	170
BXRC-30E4000-B-8x-SE	3000	80	700	3802	3422	33.1	23.2	164
BXRC-30E4000-C-8x-SE	3000	80	1050	5685	5117	33.1	34.8	163
BXRC-30E4000-D-8x-SE	3000	80	850	3827	3444	27.7	23.5	163
BXRC-30G4000-B-8x-SE	3000	90	700	3086	2778	33.1	23.2	133
BXRC-30G4000-C-8x-SE	3000	90	1050	4615	4153	33.1	34.8	133
BXRC-30G4000-D-8x-SE	3000	90	850	3106	2796	27.7	23.5	132
BXRC-30G40H0-B-8x-SE	3000	90	700	3232	2908	33.1	23.2	139
BXRC-30G40H0-C-8x-SE	3000	90	1050	4832	4349	33.1	34.8	139
BXRC-30G40H0-D-8x-SE	3000	90	850	3253	2927	27.7	23.5	138
BXRC-35E4000-B-8x-SE	3500	80	700	3891	3502	33.1	23.2	168
BXRC-35E4000-C-8x-SE	3500	80	1050	5819	5237	33.1	34.8	167
BXRC-35E4000-D-8x-SE	3500	80	850	3917	3525	27.7	23.5	167
BXRC-35G4000-B-8x-SE	3500	90	700	3198	2878	33.1	23.2	138
BXRC-35G4000-C-8x-SE	3500	90	1050	4782	4304	33.1	34.8	138
BXRC-35G4000-D-8x-SE	3500	90	850	3219	2897	27.7	23.5	137
BXRC-40C4001-B-8x-SE	4000	70	700	4093	3683	33.1	23.2	177
BXRC-40C4001-C-8x-SE	4000	70	1050	6120	5508	33.1	34.8	176
BXRC-40C4001-D-8x-SE	4000	70	850	4119	3707	27.7	23.5	175
BXRC-40E4000-B-8x-SE	4000	80	700	3914	3522	33.1	23.2	169
BXRC-40E4000-C-8x-SE	4000	80	1050	5852	5267	33.1	34.8	168
BXRC-40E4000-D-8x-SE	4000	80	850	3939	3545	27.7	23.5	168
BXRC-40G4000-B-8x-SE	4000	90	700	3265	2939	33.1	23.2	141
BXRC-40G4000-C-8x-SE	4000	90	1050	4883	4394	33.1	34.8	140
BXRC-40G4000-D-8x-SE	4000	90	850	3287	2958	27.7	23.5	140

Notes for Table 2:

- Nominal CCT as defined by ANSI C78.377-2011. Products with a CCT of 5000K-6500K are hot targeted to $T_c = 85^\circ\text{C}$.
- CRI values are minimums for all products. Minimum R_g value for 80 CRI products is 0, the minimum R_g value for 90 CRI products is 50. Bridgelux maintains a ± 3 tolerance for all CRI and R_g values.
- Drive current is referred to as nominal drive current.
- Typical stabilized DC performance values are provided as reference only and are not a guarantee of performance.
- Typical performance is estimated based on operation under DC (direct current) with LED array mounted onto a heat sink with thermal interface material and the case temperature maintained at 85°C . Based on Bridgelux test setup, values may vary depending on the thermal design of the luminaire and/or the exposed environment to which the product is subjected.
- Minimum flux values at elevated temperatures are provided for reference only and are not guaranteed by 100% production testing. Based on Bridgelux test setup, values may vary depending on the thermal design of the luminaire and/or the exposed environment to which the product is subjected.

Product Selection Guide

Table 2: Selection Guide, Stabilized DC Performance ($T_c = 85^\circ\text{C}$)^{4,5} (continued)

Part Number	Nominal CCT ¹ (K)	CRI ²	Nominal Drive Current ³ (mA)	Typical DC Flux ^{4,5} $T_c = 85^\circ\text{C}$ (lm)	Minimum DC Flux ⁶ $T_c = 85^\circ\text{C}$ (lm)	Typical V_f (V)	Typical Power (W)	Typical Efficacy (lm/W)
BXRC-50C4001-B-8x-SE	5000	70	700	4115	3704	331	23.2	177
BXRC-50C4001-C-8x-SE	5000	70	1050	6153	5538	331	34.8	177
BXRC-50C4001-D-8x-SE	5000	70	850	4142	3728	277	23.5	176
BXRC-50E4001-B-8x-SE	5000	80	700	3958	3563	331	23.2	171
BXRC-50E4001-C-8x-SE	5000	80	1050	5919	5327	331	34.8	170
BXRC-50E4001-D-8x-SE	5000	80	850	3984	3586	277	23.5	169
BXRC-50G4001-B-8x-SE	5000	90	700	3422	3080	331	23.2	148
BXRC-50G4001-C-8x-SE	5000	90	1050	5117	4605	331	34.8	147
BXRC-50G4001-D-8x-SE	5000	90	850	3444	3100	277	23.5	146
BXRC-57C4001-B-8x-SE	5700	70	700	4003	3603	331	23.2	173
BXRC-57C4001-C-8x-SE	5700	70	1050	5986	5387	331	34.8	172
BXRC-57C4001-D-8x-SE	5700	70	850	4029	3626	277	23.5	171
BXRC-57E4001-B-8x-SE	5700	80	700	3802	3422	331	23.2	164
BXRC-57E4001-C-8x-SE	5700	80	1050	5685	5117	331	34.8	163
BXRC-57E4001-D-8x-SE	5700	80	850	3827	3444	277	23.5	163
BXRC-65C4001-B-8x-SE	6500	70	700	4003	3603	331	23.2	173
BXRC-65C4001-C-8x-SE	6500	70	1050	5986	5387	331	34.8	172
BXRC-65C4001-D-8x-SE	6500	70	850	4029	3626	277	23.5	171
BXRC-65E4001-B-8x-SE	6500	80	700	3847	3462	331	23.2	166
BXRC-65E4001-C-8x-SE	6500	80	1050	5752	5177	331	34.8	165
BXRC-65E4001-D-8x-SE	6500	80	850	3872	3485	277	23.5	165

Notes for Table 2:

- Nominal CCT as defined by ANSI C78.377-2011. Products with a CCT of 5000K-6500K are hot targeted to $T_c = 85^\circ\text{C}$.
- CRI values are minimums for all products. Minimum Rg value for 80 CRI products is 0, the minimum Rg value for 90 CRI products is 50. Bridgelux maintains a ± 3 tolerance for all CRI and Rg values.
- Drive current is referred to as nominal drive current.
- Typical stabilized DC performance values are provided as reference only and are not a guarantee of performance.
- Typical performance is estimated based on operation under DC (direct current) with LED array mounted onto a heat sink with thermal interface material and the case temperature maintained at 85°C . Based on Bridgelux test setup, values may vary depending on the thermal design of the luminaire and/or the exposed environment to which the product is subjected.
- Minimum flux values at elevated temperatures are provided for reference only and are not guaranteed by 100% production testing. Based on Bridgelux test setup, values may vary depending on the thermal design of the luminaire and/or the exposed environment to which the product is subjected.

Performance at Commonly Used Drive Currents

Vero LED arrays are tested to the specifications shown using the nominal drive currents in Table 1. Vero SE may also be driven at other drive currents dependent on specific application design requirements. The performance at any drive current can be derived from the current vs. voltage characteristics shown in Figures 1, 2 & 3 and the flux vs. current characteristics shown in Figures 4, 5 & 6. The performance at commonly used drive currents is summarized in Table 3.

Table 3: Product Performance at Commonly Used Drive Currents

Part Number	CRI	Drive Current ¹ (mA)	Typical V _f T _c = 25°C (V)	Typical Power T _c = 25°C (W)	Typical Flux ² T _c = 25°C (lm)	Typical DC Flux ³ T _c = 85°C (lm)	Typical Efficacy T _c = 25°C (lm/W)
BXRC-27E4000-B-8x-SE	80	350	32.7	11.4	2087	1878	182
		525	33.3	17.5	3025	2723	173
		700	33.9	23.7	3976	3578	168
		900	34.5	31.0	4988	4489	161
		1400	36.0	50.4	7501	6751	149
		2000	37.5	75.1	10363	9327	138
BXRC-27E4000-C-8x-SE	80	525	32.7	17.2	3121	2809	182
		785	33.3	26.1	4511	4060	173
		1050	33.9	35.6	5945	5351	167
		1170	34.1	39.9	6530	5877	164
		2100	36.0	75.5	11217	10095	148
		3000	37.5	112.6	15496	13947	138
BXRC-27E4000-D-8x-SE	80	425	27.2	11.6	2101	1891	182
		650	27.7	18.0	3100	2790	172
		850	28.2	23.9	4002	3602	167
		1050	28.6	30.0	4837	4354	161
		1700	29.9	50.9	7551	6795	148
		2500	31.3	78.3	10704	9634	137
BXRC-27G4000-B-8x-SE	90	350	32.7	11.4	1722	1550	151
		525	33.3	17.5	2496	2246	143
		700	33.9	23.7	3280	2952	138
		900	34.5	31.0	4115	3703	133
		1400	36.0	50.4	6189	5570	123
		2000	37.5	75.1	8550	7695	114
BXRC-27G4000-C-8x-SE	90	525	32.7	17.2	2575	2317	150
		785	33.3	26.1	3721	3349	142
		1050	33.9	35.6	4905	4414	138
		1170	34.1	39.9	5387	4849	135
		2100	36.0	75.5	9254	8329	122
		3000	37.5	112.6	12784	11506	114
BXRC-27G4000-D-8x-SE	90	425	27.2	11.6	1733	1560	150
		650	27.7	18.0	2558	2302	142
		850	28.2	23.9	3302	2971	138
		1050	28.6	30.0	3991	3592	133
		1700	29.9	50.9	6229	5606	122
		2500	31.3	78.3	8831	7948	113

Notes for Table 3:

1. Alternate drive currents in Table 3 are provided for reference only and are not a guarantee of performance.
2. Bridgelux maintains a ± 7% tolerance on flux measurements.
3. Typical stabilized DC performance values are provided as reference only and are not a guarantee of performance.

Performance at Commonly Used Drive Currents

Table 3: Product Performance at Commonly Used Drive Currents (Continued)

Part Number	CRI	Drive Current ¹ (mA)	Typical V _f T _c = 25°C (V)	Typical Power T _c = 25°C (W)	Typical Flux ² T _c = 25°C (lm)	Typical DC Flux ³ T _c = 85°C (lm)	Typical Efficacy T _c = 25°C (lm/W)
BXRC-27G40H0-B-8x-SE	90	350	32.7	11.4	1796	1617	157
		525	33.3	17.5	2604	2343	149
		700	33.9	23.7	3422	3080	144
		900	34.5	31.0	4293	3863	138
		1400	36.0	50.4	6456	5810	128
		2000	37.5	75.1	8919	8027	119
BXRC-27G40H0-C-8x-SE	90	525	32.7	17.2	2686	2417	157
		785	33.3	26.1	3882	3494	149
		1050	33.9	35.6	5117	4605	144
		1170	34.1	39.9	5620	5058	141
		2100	36.0	75.5	9654	8688	128
		3000	37.5	112.6	13336	12003	118
BXRC-27G40H0-D-8x-SE	90	425	27.2	11.6	1808	1627	157
		650	27.7	18.0	2668	2401	148
		850	28.2	23.9	3444	3100	144
		1050	28.6	30.0	4163	3747	139
		1700	29.9	50.9	6498	5848	128
		2500	31.3	78.3	9212	8291	118
BXRC-30C4001-B-8x-SE	70	350	32.7	11.4	2322	2090	203
		525	33.3	17.5	3366	3029	193
		700	33.9	23.7	4423	3981	187
		900	34.5	31.0	5549	4994	179
		1400	36.0	50.4	8345	7511	166
		2000	37.5	75.1	11529	10376	154
BXRC-30C4001-C-8x-SE	70	525	32.7	17.2	3472	3125	202
		785	33.3	26.1	5018	4516	192
		1050	33.9	35.6	6614	5953	186
		1170	34.1	39.9	7265	6538	182
		2100	36.0	75.5	12479	11231	165
		3000	37.5	112.6	17240	15516	153
BXRC-30C4001-D-8x-SE	70	425	27.2	11.6	2337	2103	202
		650	27.7	18.0	3449	3104	192
		850	28.2	23.9	4452	4007	186
		1050	28.6	30.0	5382	4843	179
		1700	29.9	50.9	8400	7560	165
		2500	31.3	78.3	11908	10718	152
BXRC-30E4000-B-8x-SE	80	350	32.7	11.4	2218	1996	194
		525	33.3	17.5	3215	2893	184
		700	33.9	23.7	4224	3802	178
		900	34.5	31.0	5299	4770	171
		1400	36.0	50.4	7970	7173	158
		2000	37.5	75.1	11011	9910	147

Notes for Table 3:

1. Alternate drive currents in Table 3 are provided for reference only and are not a guarantee of performance.
2. Bridgelux maintains a ± 7% tolerance on flux measurements.
3. Typical stabilized DC performance values are provided as reference only and are not a guarantee of performance.

Performance at Commonly Used Drive Currents

Table 3: Product Performance at Commonly Used Drive Currents (Continued)

Part Number	CRI	Drive Current ¹ (mA)	Typical V _f T _c = 25°C (V)	Typical Power T _c = 25°C (W)	Typical Flux ² T _c = 25°C (lm)	Typical DC Flux ³ T _c = 85°C (lm)	Typical Efficacy T _c = 25°C (lm/W)
BXRC-30E4000-C-8x-SE	80	525	32.7	17.2	3316	2984	193
		785	33.3	26.1	4793	4313	183
		1050	33.9	35.6	6317	5685	178
		1170	34.1	39.9	6938	6244	174
		2100	36.0	75.5	11918	10726	158
		3000	37.5	112.6	16465	14818	146
BXRC-30E4000-D-8x-SE	80	425	27.2	11.6	2232	2009	193
		650	27.7	18.0	3294	2965	183
		850	28.2	23.9	4252	3827	178
		1050	28.6	30.0	5140	4626	171
		1700	29.9	50.9	8022	7220	158
		2500	31.3	78.3	11373	10236	145
BXRC-30G4000-B-8x-SE	90	350	32.7	11.4	1800	1620	157
		525	33.3	17.5	2609	2349	149
		700	33.9	23.7	3429	3086	145
		900	34.5	31.0	4302	3872	139
		1400	36.0	50.4	6470	5823	128
		2000	37.5	75.1	8938	8044	119
BXRC-30G4000-C-8x-SE	90	525	32.7	17.2	2692	2423	157
		785	33.3	26.1	3891	3502	149
		1050	33.9	35.6	5128	4615	144
		1170	34.1	39.9	5632	5069	141
		2100	36.0	75.5	9675	8707	128
		3000	37.5	112.6	13366	12029	119
BXRC-30G4000-D-8x-SE	90	425	27.2	11.6	1812	1631	157
		650	27.7	18.0	2674	2407	148
		850	28.2	23.9	3452	3106	144
		1050	28.6	30.0	4172	3755	139
		1700	29.9	50.9	6512	5861	128
		2500	31.3	78.3	9232	8309	118
BXRC-30G40H0-B-8x-SE	90	350	32.7	11.4	1885	1696	165
		525	33.3	17.5	2732	2459	156
		700	33.9	23.7	3591	3232	152
		900	34.5	31.0	4505	4054	145
		1400	36.0	50.4	6775	6097	135
		2000	37.5	75.1	9359	8423	125
BXRC-30G40H0-C-8x-SE	90	525	32.7	17.2	2819	2537	164
		785	33.3	26.1	4074	3666	156
		1050	33.9	35.6	5369	4832	151
		1170	34.1	39.9	5897	5308	148
		2100	36.0	75.5	10131	9117	134
		3000	37.5	112.6	13995	12596	124

Notes for Table 3:

1. Alternate drive currents in Table 3 are provided for reference only and are not a guarantee of performance.
2. Bridgelux maintains a ± 7% tolerance on flux measurements.
3. Typical stabilized DC performance values are provided as reference only and are not a guarantee of performance.

Performance at Commonly Used Drive Currents

Table 3: Product Performance at Commonly Used Drive Currents (Continued)

Part Number	CRI	Drive Current ¹ (mA)	Typical V _f T _c = 25°C (V)	Typical Power T _c = 25°C (W)	Typical Flux ² T _c = 25°C (lm)	Typical DC Flux ³ T _c = 85°C (lm)	Typical Efficacy T _c = 25°C (lm/W)
BXRC-30G40H0-D-8x-SE	90	425	27.2	11.6	1897	1708	164
		650	27.7	18.0	2800	2520	155
		850	28.2	23.9	3614	3253	151
		1050	28.6	30.0	4369	3932	145
		1700	29.9	50.9	6819	6137	134
		2500	31.3	78.3	9667	8700	123
BXRC-35E4000-B-8x-SE	80	350	32.7	11.4	2270	2043	198
		525	33.3	17.5	3290	2961	188
		700	33.9	23.7	4324	3891	182
		900	34.5	31.0	5424	4882	175
		1400	36.0	50.4	8158	7342	162
		2000	37.5	75.1	11270	10143	150
BXRC-35E4000-C-8x-SE	80	525	32.7	17.2	3394	3055	198
		785	33.3	26.1	4905	4415	188
		1050	33.9	35.6	6465	5819	182
		1170	34.1	39.9	7101	6391	178
		2100	36.0	75.5	12199	10979	161
		3000	37.5	112.6	16852	15167	150
BXRC-35E4000-D-8x-SE	80	425	27.2	11.6	2285	2056	198
		650	27.7	18.0	3372	3034	187
		850	28.2	23.9	4352	3917	182
		1050	28.6	30.0	5261	4735	175
		1700	29.9	50.9	8211	7390	161
		2500	31.3	78.3	11641	10477	149
BXRC-35G4000-B-8x-SE	90	350	32.7	11.4	1865	1679	163
		525	33.3	17.5	2704	2434	155
		700	33.9	23.7	3553	3198	150
		900	34.5	31.0	4458	4012	144
		1400	36.0	50.4	6704	6034	133
		2000	37.5	75.1	9262	8336	123
BXRC-35G4000-C-8x-SE	90	525	32.7	17.2	2789	2510	163
		785	33.3	26.1	4032	3628	154
		1050	33.9	35.6	5314	4782	149
		1170	34.1	39.9	5836	5253	146
		2100	36.0	75.5	10025	9023	133
		3000	37.5	112.6	13850	12465	123
BXRC-35G4000-D-8x-SE	90	425	27.2	11.6	1878	1690	163
		650	27.7	18.0	2771	2494	154
		850	28.2	23.9	3577	3219	149
		1050	28.6	30.0	4323	3891	144
		1700	29.9	50.9	6748	6073	133
		2500	31.3	78.3	9567	8610	122

Notes for Table 3:

1. Alternate drive currents in Table 3 are provided for reference only and are not a guarantee of performance.
2. Bridgelux maintains a ± 7% tolerance on flux measurements.
3. Typical stabilized DC performance values are provided as reference only and are not a guarantee of performance.

Performance at Commonly Used Drive Currents

Table 3: Product Performance at Commonly Used Drive Currents (Continued)

Part Number	CRI	Drive Current ¹ (mA)	Typical V_f $T_c = 25^\circ\text{C}$ (V)	Typical Power $T_c = 25^\circ\text{C}$ (W)	Typical Flux ² $T_c = 25^\circ\text{C}$ (lm)	Typical DC Flux ³ $T_c = 85^\circ\text{C}$ (lm)	Typical Efficacy $T_c = 25^\circ\text{C}$ (lm/W)
BXRC-40C4001-B-8x-SE	70	350	32.7	11.4	2387	2148	209
		525	33.3	17.5	3460	3114	198
		700	33.9	23.7	4547	4093	192
		900	34.5	31.0	5705	5134	184
		1400	36.0	50.4	8580	7722	170
		2000	37.5	75.1	11853	10668	158
BXRC-40C4001-C-8x-SE	70	525	32.7	17.2	3570	3213	208
		785	33.3	26.1	5159	4643	198
		1050	33.9	35.6	6800	6120	191
		1170	34.1	39.9	7469	6722	187
		2100	36.0	75.5	12830	11547	170
		3000	37.5	112.6	17724	15951	157
BXRC-40C4001-D-8x-SE	70	425	27.2	11.6	2403	2163	208
		650	27.7	18.0	3546	3191	197
		850	28.2	23.9	4577	4119	191
		1050	28.6	30.0	5533	4979	184
		1700	29.9	50.9	8636	7772	170
		2500	31.3	78.3	12243	11019	156
BXRC-40E4000-B-8x-SE	80	350	32.7	11.4	2283	2055	200
		525	33.3	17.5	3309	2978	189
		700	33.9	23.7	4349	3914	183
		900	34.5	31.0	5455	4910	176
		1400	36.0	50.4	8205	7384	163
		2000	37.5	75.1	11335	10201	151
BXRC-40E4000-C-8x-SE	80	525	32.7	17.2	3414	3072	199
		785	33.3	26.1	4934	4440	189
		1050	33.9	35.6	6503	5852	183
		1170	34.1	39.9	7142	6428	179
		2100	36.0	75.5	12269	11042	162
		3000	37.5	112.6	16949	15254	151
BXRC-40E4000-D-8x-SE	80	425	27.2	11.6	2298	2068	199
		650	27.7	18.0	3391	3052	188
		850	28.2	23.9	4377	3939	183
		1050	28.6	30.0	5291	4762	176
		1700	29.9	50.9	8258	7433	162
		2500	31.3	78.3	11708	10537	149
BXRC-40G4000-B-8x-SE	90	350	32.7	11.4	1905	1714	166
		525	33.3	17.5	2761	2485	158
		700	33.9	23.7	3628	3265	153
		900	34.5	31.0	4551	4096	147
		1400	36.0	50.4	6845	6161	136
		2000	37.5	75.1	9456	8511	126

Notes for Table 3:

1. Alternate drive currents in Table 3 are provided for reference only and are not a guarantee of performance.
2. Bridgelux maintains a $\pm 7\%$ tolerance on flux measurements.
3. Typical stabilized DC performance values are provided as reference only and are not a guarantee of performance.

Performance at Commonly Used Drive Currents

Table 3: Product Performance at Commonly Used Drive Currents (Continued)

Part Number	CRI	Drive Current ¹ (mA)	Typical V _f T _c = 25°C (V)	Typical Power T _c = 25°C (W)	Typical Flux ² T _c = 25°C (lm)	Typical DC Flux ³ T _c = 85°C (lm)	Typical Efficacy T _c = 25°C (lm/W)
BXRC-40G4000-C-8x-SE	90	525	32.7	17.2	2848	2563	166
		785	33.3	26.1	4116	3704	158
		1050	33.9	35.6	5425	4883	153
		1170	34.1	39.9	5959	5363	149
		2100	36.0	75.5	10236	9212	135
		3000	37.5	112.6	14140	12726	126
BXRC-40G4000-D-8x-SE	90	425	27.2	11.6	1917	1725	166
		650	27.7	18.0	2829	2546	157
		850	28.2	23.9	3652	3287	153
		1050	28.6	30.0	4414	3973	147
		1700	29.9	50.9	6890	6201	135
		2500	31.3	78.3	9768	8791	125
BXRC-50C4001-B-8x-SE	70	350	32.7	11.4	2400	2160	210
		525	33.3	17.5	3479	3131	199
		700	33.9	23.7	4572	4115	193
		900	34.5	31.0	5736	5162	185
		1400	36.0	50.4	8627	7764	171
		2000	37.5	75.1	11918	10726	159
BXRC-50C4001-C-8x-SE	70	525	32.7	17.2	3589	3230	209
		785	33.3	26.1	5187	4669	199
		1050	33.9	35.6	6837	6153	192
		1170	34.1	39.9	7510	6759	188
		2100	36.0	75.5	12900	11610	171
		3000	37.5	112.6	17821	16039	158
BXRC-50C4001-D-8x-SE	70	425	27.2	11.6	2416	2174	209
		650	27.7	18.0	3565	3209	198
		850	28.2	23.9	4602	4142	192
		1050	28.6	30.0	5563	5007	185
		1700	29.9	50.9	8683	7815	171
		2500	31.3	78.3	12310	11079	157
BXRC-50E4001-B-8x-SE	80	350	32.7	11.4	2309	2078	202
		525	33.3	17.5	3347	3012	192
		700	33.9	23.7	4398	3958	186
		900	34.5	31.0	5518	4966	178
		1400	36.0	50.4	8299	7469	165
		2000	37.5	75.1	11464	10318	153
BXRC-50E4001-C-8x-SE	80	525	32.7	17.2	3453	3107	201
		785	33.3	26.1	4990	4491	191
		1050	33.9	35.6	6577	5919	185
		1170	34.1	39.9	7224	6502	181
		2100	36.0	75.5	12409	11168	164
		3000	37.5	112.6	17143	15428	152

Notes for Table 3:

1. Alternate drive currents in Table 3 are provided for reference only and are not a guarantee of performance.
2. Bridgelux maintains a ± 7% tolerance on flux measurements.
3. Typical stabilized DC performance values are provided as reference only and are not a guarantee of performance.

Performance at Commonly Used Drive Currents

Table 3: Product Performance at Commonly Used Drive Currents (Continued)

Part Number	CRI	Drive Current ¹ (mA)	Typical V _f T _c = 25°C (V)	Typical Power T _c = 25°C (W)	Typical Flux ² T _c = 25°C (lm)	Typical DC Flux ³ T _c = 85°C (lm)	Typical Efficacy T _c = 25°C (lm/W)
BXRC-50E4001-D-8x-SE	80	425	27.2	11.6	2324	2092	201
		650	27.7	18.0	3430	3087	190
		850	28.2	23.9	4427	3984	185
		1050	28.6	30.0	5351	4816	178
		1700	29.9	50.9	8353	7518	164
		2500	31.3	78.3	11841	10657	151
BXRC-50G4001-B-8x-SE	90	350	32.7	11.4	1996	1796	174
		525	33.3	17.5	2893	2604	166
		700	33.9	23.7	3802	3422	160
		900	34.5	31.0	4770	4293	154
		1400	36.0	50.4	7173	6456	142
		2000	37.5	75.1	9910	8919	132
BXRC-50G4001-C-8x-SE	90	525	32.7	17.2	2984	2686	174
		785	33.3	26.1	4313	3882	165
		1050	33.9	35.6	5685	5117	160
		1170	34.1	39.9	6244	5620	156
		2100	36.0	75.5	10726	9654	142
		3000	37.5	112.6	14818	13336	132
BXRC-50G4001-D-8x-SE	90	425	27.2	11.6	2009	1808	174
		650	27.7	18.0	2965	2668	165
		850	28.2	23.9	3827	3444	160
		1050	28.6	30.0	4626	4163	154
		1700	29.9	50.9	7220	6498	142
		2500	31.3	78.3	10236	9212	131
BXRC-57C4001-B-8x-SE	70	350	32.7	11.4	2335	2102	204
		525	33.3	17.5	3385	3046	194
		700	33.9	23.7	4448	4003	188
		900	34.5	31.0	5580	5022	180
		1400	36.0	50.4	8392	7553	167
		2000	37.5	75.1	11594	10434	154
BXRC-57C4001-C-8x-SE	70	525	32.7	17.2	3492	3142	203
		785	33.3	26.1	5046	4542	193
		1050	33.9	35.6	6651	5986	187
		1170	34.1	39.9	7306	6575	183
		2100	36.0	75.5	12549	11294	166
		3000	37.5	112.6	17336	15603	154
BXRC-57C4001-D-8x-SE	70	425	27.2	11.6	2350	2115	203
		650	27.7	18.0	3469	3122	193
		850	28.2	23.9	4477	4029	187
		1050	28.6	30.0	5412	4871	180
		1700	29.9	50.9	8447	7602	166
		2500	31.3	78.3	11975	10778	153

Notes for Table 3:

1. Alternate drive currents in Table 3 are provided for reference only and are not a guarantee of performance.
2. Bridgelux maintains a ± 7% tolerance on flux measurements.
3. Typical stabilized DC performance values are provided as reference only and are not a guarantee of performance.

Performance at Commonly Used Drive Currents

Table 3: Product Performance at Commonly Used Drive Currents (Continued)

Part Number	CRI	Drive Current ¹ (mA)	Typical V_f $T_c = 25^\circ\text{C}$ (V)	Typical Power $T_c = 25^\circ\text{C}$ (W)	Typical Flux ² $T_c = 25^\circ\text{C}$ (lm)	Typical DC Flux ³ $T_c = 85^\circ\text{C}$ (lm)	Typical Efficacy $T_c = 25^\circ\text{C}$ (lm/W)
BXRC-57E4001-B-8x-SE	80	350	32.7	11.4	2218	1996	194
		525	33.3	17.5	3215	2893	184
		700	33.9	23.7	4224	3802	178
		900	34.5	31.0	5299	4770	171
		1400	36.0	50.4	7970	7173	158
		2000	37.5	75.1	11011	9910	147
BXRC-57E4001-C-8x-SE	80	525	32.7	17.2	3316	2984	193
		785	33.3	26.1	4793	4313	183
		1050	33.9	35.6	6317	5685	178
		1170	34.1	39.9	6938	6244	174
		2100	36.0	75.5	11918	10726	158
		3000	37.5	112.6	16465	14818	146
BXRC-57E4001-D-8x-SE	80	425	27.2	11.6	2232	2009	193
		650	27.7	18.0	3294	2965	183
		850	28.2	23.9	4252	3827	178
		1050	28.6	30.0	5140	4626	171
		1700	29.9	50.9	8022	7220	158
		2500	31.3	78.3	11373	10236	145
BXRC-65C4001-B-8x-SE	70	350	32.7	11.4	2335	2102	204
		525	33.3	17.5	3385	3046	194
		700	33.9	23.7	4448	4003	188
		900	34.5	31.0	5580	5022	180
		1400	36.0	50.4	8392	7553	167
		2000	37.5	75.1	11594	10434	154
BXRC-65C4001-C-8x-SE	70	525	32.7	17.2	3492	3142	203
		785	33.3	26.1	5046	4542	193
		1050	33.9	35.6	6651	5986	187
		1170	34.1	39.9	7306	6575	183
		2100	36.0	75.5	12549	11294	166
		3000	37.5	112.6	17336	15603	154
BXRC-65C4001-D-8x-SE	70	425	27.2	11.6	2350	2115	203
		650	27.7	18.0	3469	3122	193
		850	28.2	23.9	4477	4029	187
		1050	28.6	30.0	5412	4871	180
		1700	29.9	50.9	8447	7602	166
		2500	31.3	78.3	11975	10778	153
BXRC-65E4001-B-8x-SE	80	350	32.7	11.4	2244	2019	196
		525	33.3	17.5	3252	2927	186
		700	33.9	23.7	4274	3847	180
		900	34.5	31.0	5362	4826	173
		1400	36.0	50.4	8064	7258	160
		2000	37.5	75.1	11140	10026	148

Notes for Table 3:

1. Alternate drive currents in Table 3 are provided for reference only and are not a guarantee of performance.
2. Bridgelux maintains a $\pm 7\%$ tolerance on flux measurements.
3. Typical stabilized DC performance values are provided as reference only and are not a guarantee of performance.

Performance at Commonly Used Drive Currents

Table 3: Product Performance at Commonly Used Drive Currents (Continued)

Part Number	CRI	Drive Current ¹ (mA)	Typical V_f $T_c = 25^\circ\text{C}$ (V)	Typical Power $T_c = 25^\circ\text{C}$ (W)	Typical Flux ² $T_c = 25^\circ\text{C}$ (lm)	Typical DC Flux ³ $T_c = 85^\circ\text{C}$ (lm)	Typical Efficacy $T_c = 25^\circ\text{C}$ (lm/W)
BXRC-65E4001-C-8x-SE	80	525	32.7	17.2	3355	3020	196
		785	33.3	26.1	4849	4364	186
		1050	33.9	35.6	6391	5752	180
		1170	34.1	39.9	7020	6318	176
		2100	36.0	75.5	12058	10853	160
		3000	37.5	112.6	16658	14993	148
BXRC-65E4001-D-8x-SE	80	425	27.2	11.6	2258	2033	195
		650	27.7	18.0	3333	3000	185
		850	28.2	23.9	4302	3872	180
		1050	28.6	30.0	5200	4680	173
		1700	29.9	50.9	8117	7305	160
		2500	31.3	78.3	11507	10356	147

Notes for Table 3:

1. Alternate drive currents in Table 3 are provided for reference only and are not a guarantee of performance.
2. Bridgelux maintains a $\pm 7\%$ tolerance on flux measurements.
3. Typical stabilized DC performance values are provided as reference only and are not a guarantee of performance.

Electrical Characteristics

Table 4: Electrical Characteristics

Part Number	Drive Current (mA)	Forward Voltage Pulsed, $T_c = 25^\circ\text{C}$ (V) ^{1, 2, 3, 8}			Typical Coefficient of Forward Voltage ⁴ $\Delta V_f / \Delta T_c$ (mV/ $^\circ\text{C}$)	Typical Thermal Resistance Junction to Case ^{5,6} R_{j-c} ($^\circ\text{C}/\text{W}$)	Driver Selection Voltages ⁷ (V)	
		Minimum	Typical	Maximum			V_f Min. Hot $T_c = 105^\circ\text{C}$ (V)	V_f Max. Cold $T_c = -40^\circ\text{C}$ (V)
BXRC-xxx400x-B-8x-SE	700	31.4	33.9	36.4	-10.93	0.14	30.5	37.2
	2000	34.7	37.5	40.3	-12.10	0.23	33.7	41.1
BXRC-xxx400x-C-8x-SE	1050	31.4	33.9	36.4	-10.93	0.12	30.5	37.2
	3000	34.7	37.5	40.3	-12.10	0.20	33.7	41.1
BXRC-xxx400x-D-8x-SE	850	26.1	28.2	30.3	-9.10	0.13	25.4	30.9
	2500	29.0	31.3	33.6	-10.10	0.22	28.1	34.3

Notes for Table 4:

- Parts are tested in pulsed conditions, $T_c = 25^\circ\text{C}$. Pulse width is 10ms.
- Voltage minimum and maximum are provided for reference only and are not a guarantee of performance.
- Bridgelux maintains a tester tolerance of $\pm 0.10\text{V}$ on forward voltage measurements.
- Typical coefficient of forward voltage tolerance is $\pm 0.1\text{mV}$ for nominal current.
- Thermal resistance values are based from test data of a 3000K 80 CRI product.
- Thermal resistance value was calculated using total electrical input power; optical power was not subtracted from input power. The thermal interface material used during testing is not included in the thermal resistance value.
- V_f min hot and max cold values are provided as reference only and are not guaranteed by test. These values are provided to aid in driver design and selection over the operating range of the product.
- This product has been designed and manufactured per IEC 62031:2014. This product has passed dielectric withstand voltage testing at 1140 V. The working voltage designated for the insulation is 70V d.c. The maximum allowable voltage across the array must be determined in the end product application.

Eye Safety

Table 5: Eye Safety Risk Group (RG) Classifications

Part Number	Drive Current (mA)	CCT			
		2700K/3000K	4000K ²	5000K ³	6500K ⁴
BXRC-xxx400x-B-8x-SE	1440	RG1	RG1	RG1	RG1
	2000	RG1	RG1	RG1	RG2
BXRC-xxx400x-C-8x-SE	1440	RG1	RG1	RG1	RG1
	1995	RG1	RG1	RG1	RG2
	2650	RG1	RG1	RG2	RG2
	3000	RG1	RG2	RG2	RG2
BXRC-xxx400x-D-8x-SE	1730	RG1	RG1	RG1	RG1
	2400	RG1	RG1	RG1	RG2
	2500	RG1	RG1	RG2	RG2

Notes for Table 5:

1. Eye safety classification for the use of Bridgelux V Series LED arrays is in accordance with specification IEC/TR 62778: Application of IEC 62471 for the assessment of blue light hazard to light sources and luminaires.
2. For products classified as RG2 at 4000K, Ethr- 1980 lx.
3. For products classified as RG2 at 5000K Ethr- 1530 lx.
4. For products classified as RG2 at 6500K, Ethr- 1170 lx.
5. Please contact your Bridgelux sales representative for Ethr values at specific drive currents and CCTs not listed.

Absolute Maximum Ratings

Table 6: Maximum Ratings

Parameter	Maximum Rating		
LED Junction Temperature (T_j)	150°C		
Storage Temperature	-40°C to +105°C		
Operating Case Temperature ¹ (T_c)	105°C		
Soldering Temperature ²	300°C or lower for a maximum of 6 seconds		
	BXRC-xxx400x-B-8x-SE	BXRC-xxx400x-C-8x-SE	BXRC-xxx400x-D-8x-SE
Maximum Drive Current ³	2000 mA	3000 mA	2500 mA
Maximum Peak Pulsed Drive Current ⁴	2240 mA	3360 mA	2800 mA
Maximum Reverse Voltage ⁵	-60V	-60V	-50V

Notes for Table 6:

1. For IEC 62717 requirement, please consult your Bridgelux sales representative.
2. Refer to Bridgelux Application Note AN121: Assembly Considerations for Bridgelux Vero SE LED Arrays.
3. Arrays may be driven at higher currents however lumen maintenance may be reduced and warranty will not apply.
4. Bridgelux recommends a maximum duty cycle of 10% and pulse width of 20 ms when operating LED Arrays at maximum peak pulsed current specified. Maximum peak pulsed currents indicate values where LED Arrays can be driven without catastrophic failures.
5. Light emitting diodes are not designed to be driven in reverse voltage and will not produce light under this condition. Maximum rating provided for reference only.

Performance Curves

Figure 1: Vero SE 18B Drive Current vs. Voltage

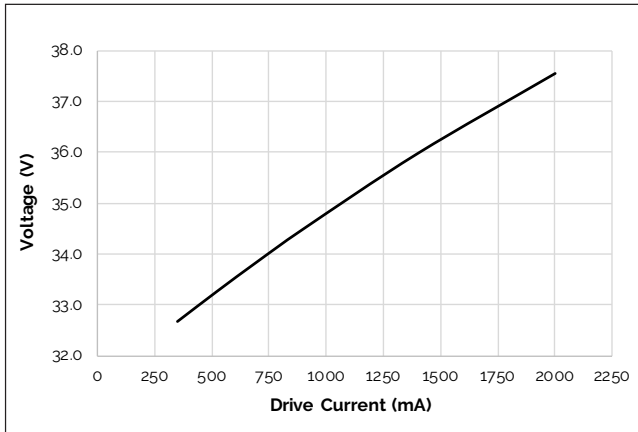

Figure 2: Vero SE 18C Drive Current vs. Voltage

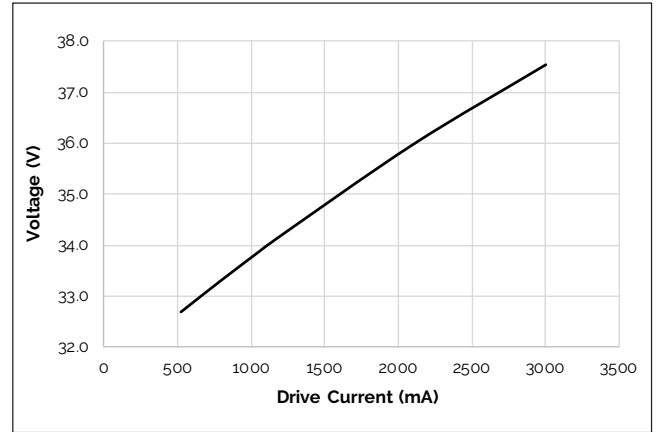

Figure 3: Vero SE 18D Drive Current vs. Voltage

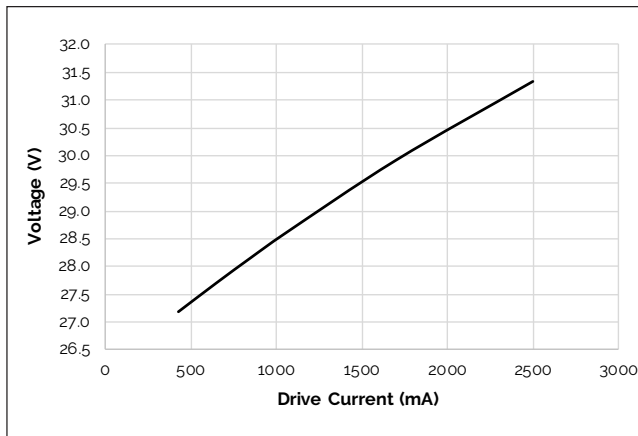

Figure 4: Vero SE 18B Typical Relative Flux vs. Current

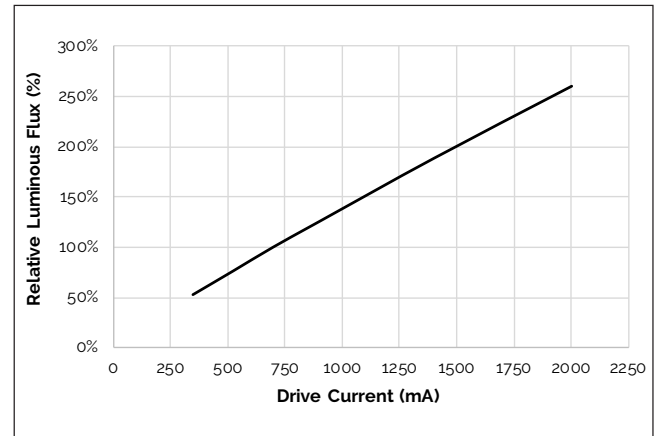

Figure 5: Vero SE 18C Typical Relative Flux vs. Current

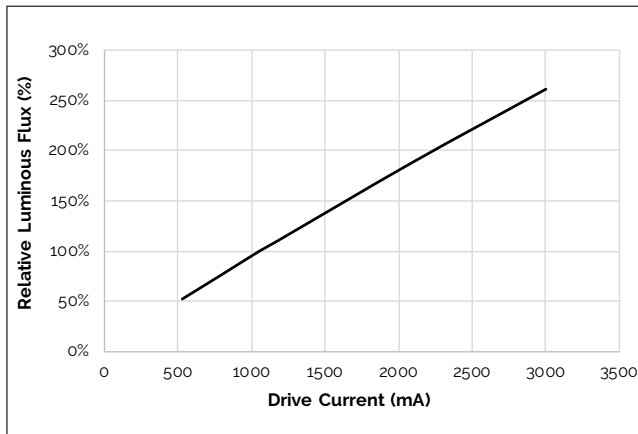
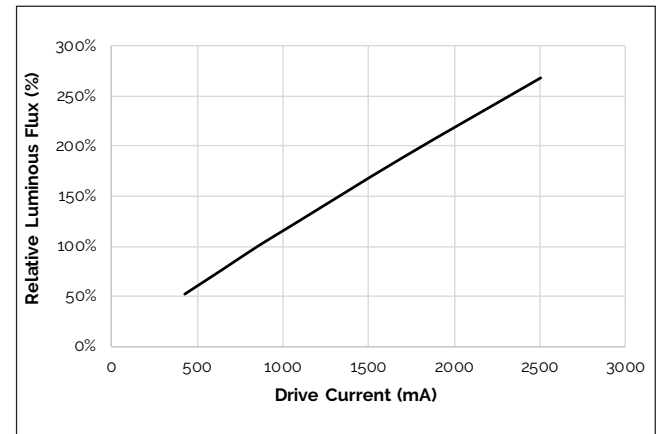

Figure 6 Vero SE 18D Typical Relative Flux vs. Current



Notes for Figures 1-6:

1. Bridgelux does not recommend driving high power LEDs at low currents. Doing so may produce unpredictable results. Pulse width modulation (PWM) is recommended for dimming effects.
2. Products tested under pulsed condition (10ms pulse width) at nominal test current where T_j (junction temperature) = T_c (case temperature) = 25°C.

Performance Curves

Figure 7: Typical DC Flux vs. Case Temperature

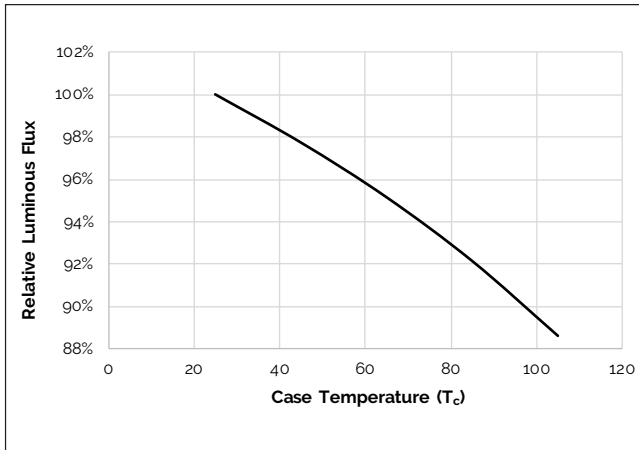

Figure 8: Typical DC ccy Shift vs. Case Temperature

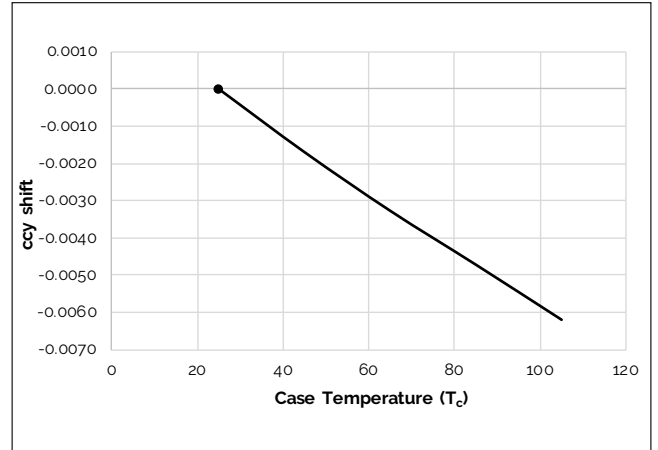

Figure 9: Typical DC ccx Shift vs. Case Temperature

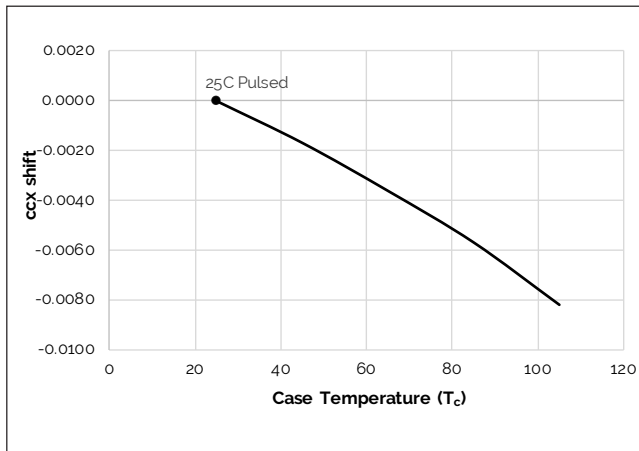
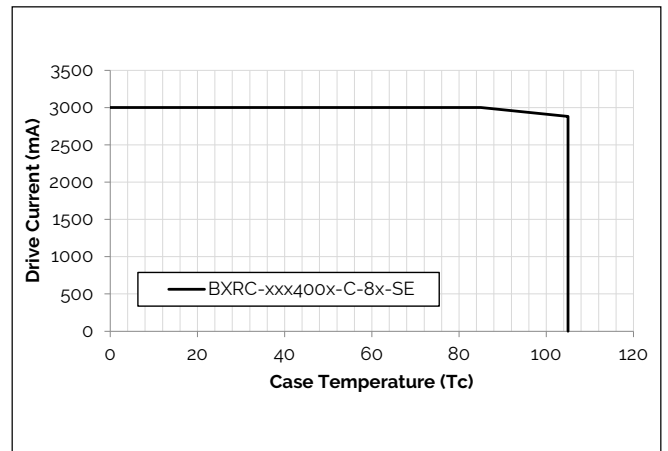
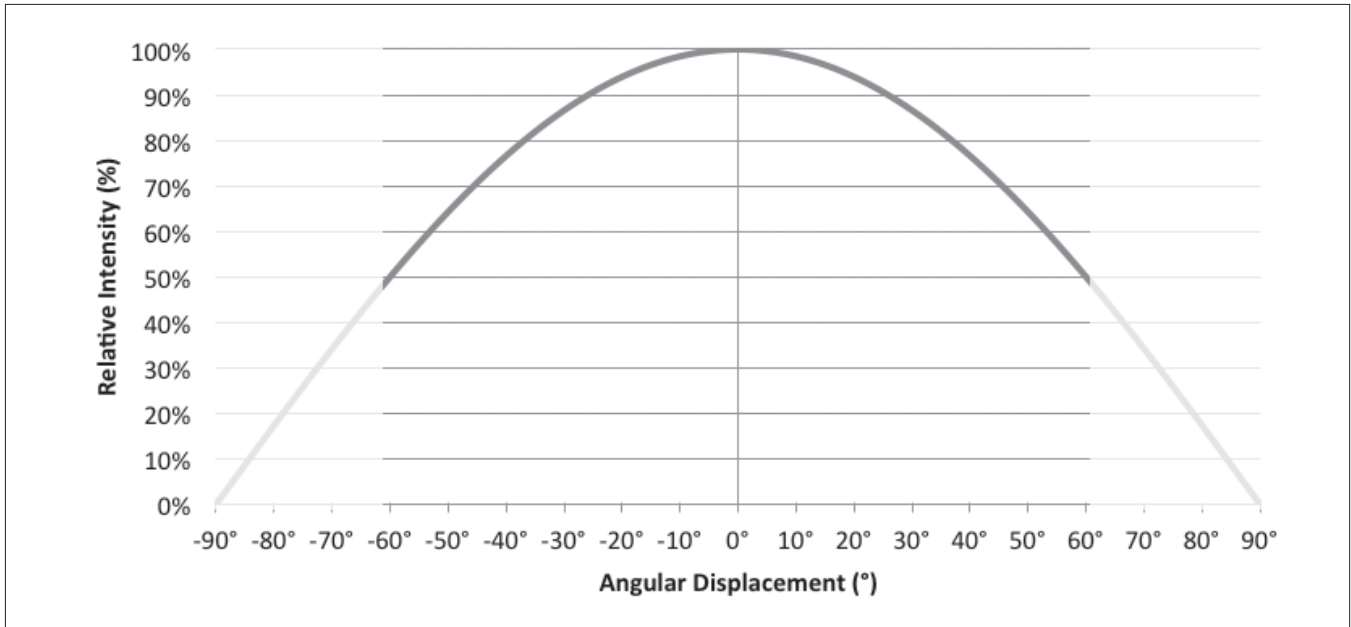

Figure 10: Derating Curve



Typical Radiation Pattern

Figure 11: Typical Spatial Radiation Pattern



Note for Figure 11:

1. Typical viewing angle is 120°.
2. The viewing angle is defined as the off axis angle from the centerline where intensity is ½ of the peak value.

Figure 12: Typical Polar Radiation Pattern

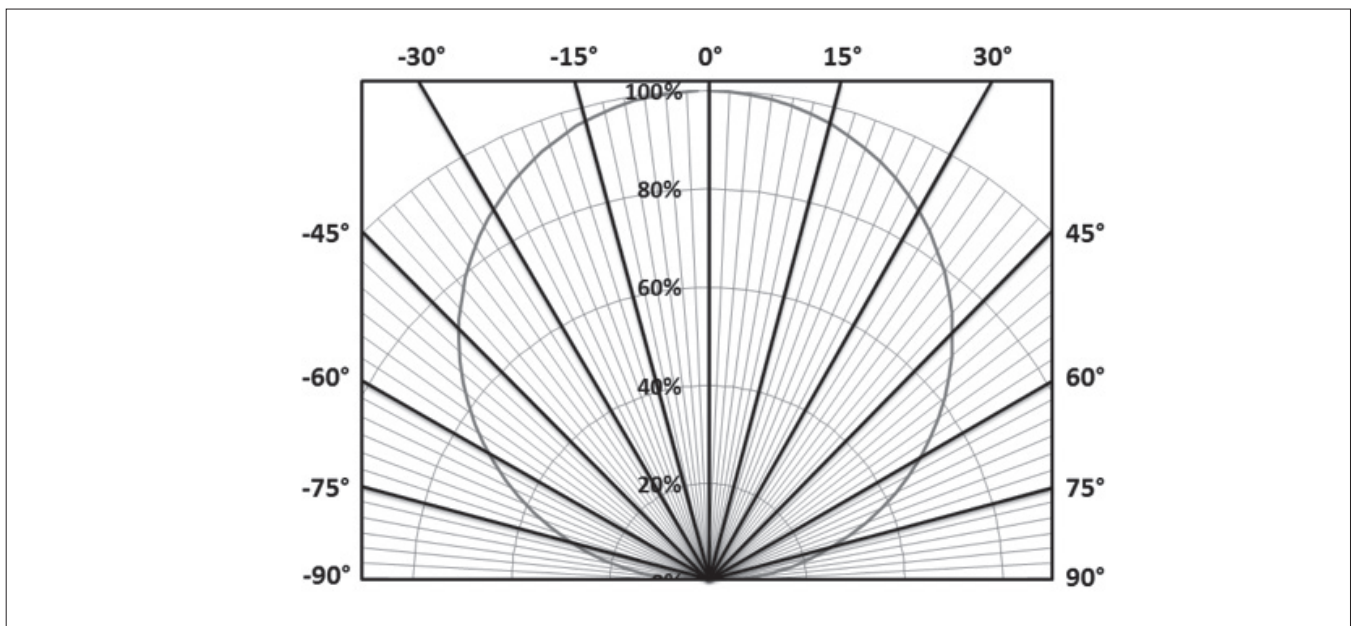

Typical Color Spectrum

Figure 13: Typical Color Spectrum

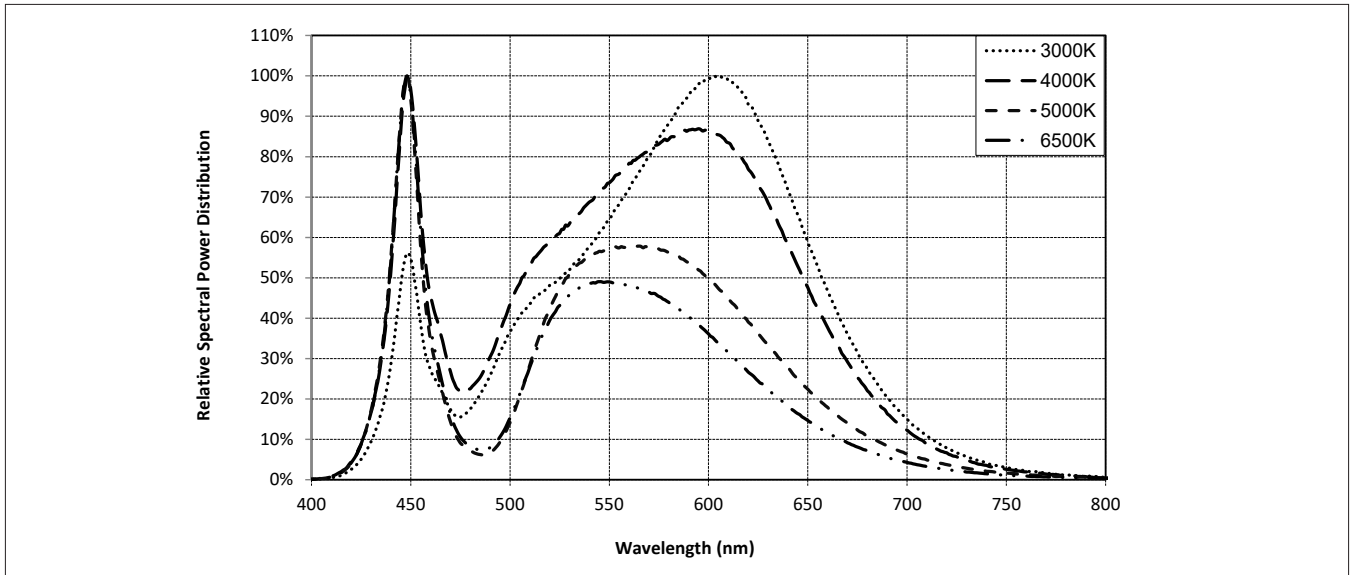

Note for Figure 13:

1. Color spectra measured at nominal current for $T_j = T_c = 25^\circ\text{C}$.
2. Color spectra shown is 3000K and 80 CRI.
3. Color spectra shown is 4000K and 80 CRI.
4. Color spectra shown is 5000K and 70 CRI.
4. Color spectra shown is 6500K and 70 CRI.

Mechanical Dimensions

Figure 14: Drawing for Vero SE 18 LED Array

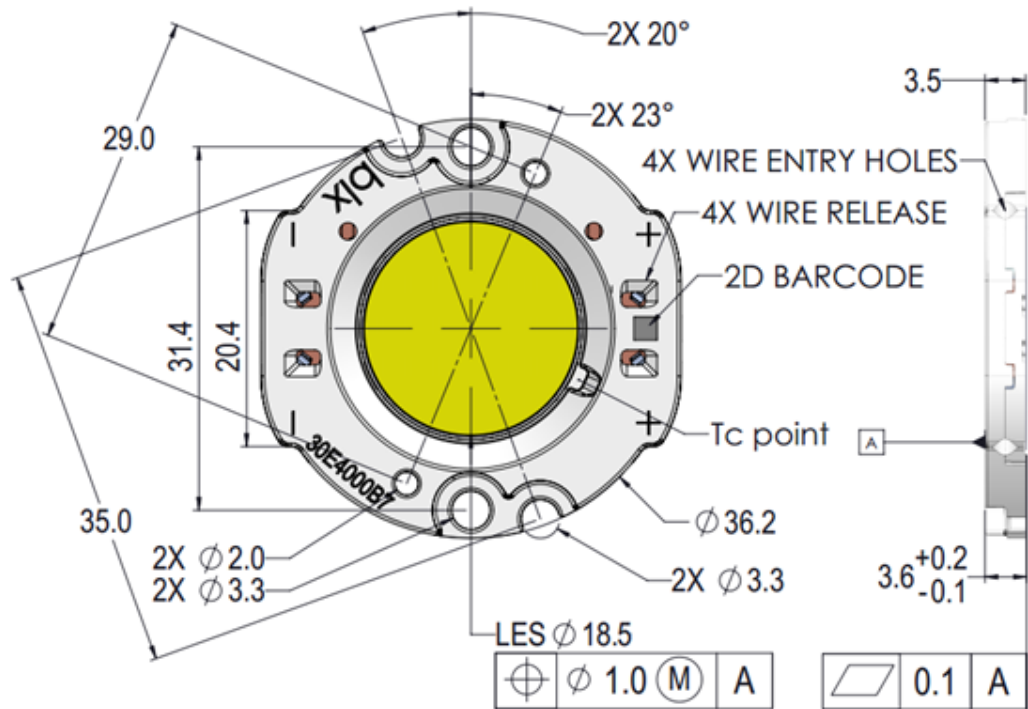

Notes for Figure 14:

1. Drawings are not to scale.
2. Drawing dimensions are in millimeters.
3. Unless otherwise specified, tolerances are ± 0.1 mm.
4. Mounting holes (2X) are for M3 screws.
5. Bridgelux recommends two tapped holes for mounting screws with 31.4 ± 0.10 mm center-to-center spacing.
6. Screws with flat shoulders (pan, dome, button, round, truss, mushroom) provide optimal torque control. Do NOT use flat, countersink, or raised head screws.
7. The optical center of the LED Array is nominally defined by the mechanical center of the array to a tolerance of ± 0.2 mm.
8. Bridgelux maintains a flatness of 0.10mm across the mounting surface of the array

Color Binning Information

Figure 15: Warm and Neutral White Test Bins in xy Color Space

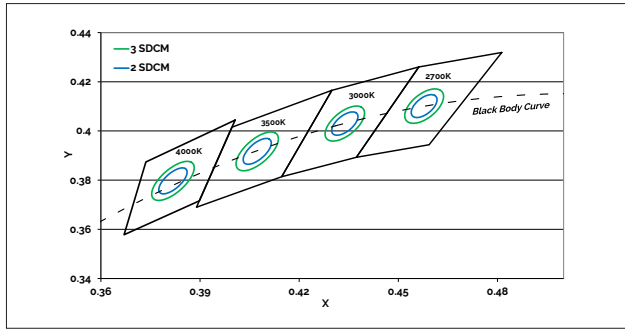

Note: Pulsed Test Conditions, $T_c = 25^\circ\text{C}$

Table 7: Warm and Neutral White xy Bin Coordinates and Associated Typical CCT

Bin Code	2700K	3000K	3500K	4000K
ANSI Bin (for reference only)	(2580K - 2870K)	(2870K - 3220K)	(3220K - 3710K)	(3710K - 4260K)
83 (3 SDCM)	(2651K - 2794K)	(2968K - 3136K)	(3369K - 3586K)	(3851K - 4130K)
82 (2 SDCM)	(2674K - 2769K)	(2995K - 3107K)	(3404K - 3548K)	(3895K - 4081K)
Center Point (x,y)	(0.4578, 0.4101)	(0.4338, 0.403)	(0.4073, 0.3917)	(0.3818, 0.3797)

Figure 16: Cool White Test Bins in xy Color Space

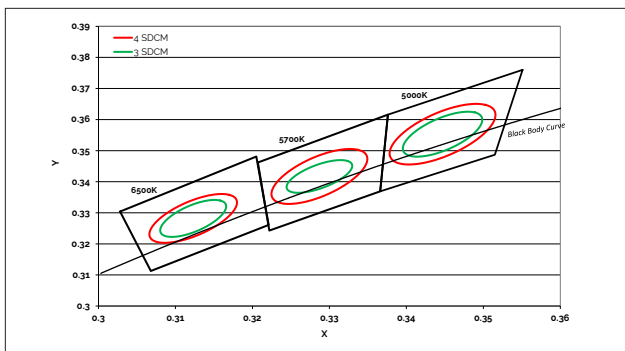

Note: Pulsed Test Conditions, $T_c = 25^\circ\text{C}$

Table 8: Cool White xy Bin Coordinates and Associated Typical CCT (product is hot targeted to $T_c = 85^\circ\text{C}$)

Bin Code	5000K	5700K	6500K
ANSI Bin (for reference only)	(4745K - 5311K)	(5312K - 6022K)	(6022K - 7042K)
84 (4 SDCM)	(4801K - 5282K)	(5481K - 5829K)	(6270K - 6765K)
83 (3 SDCM)	(4835K - 5215K)	(5490K - 5820K)	(6250K - 6745K)
Center Point (x,y)	(0.3447, 0.3553)	(0.3287, 0.3417)	(0.3123, 0.3282)

Packaging and Labeling

Figure 17: Drawing for Vero SE 18 Packaging Tray

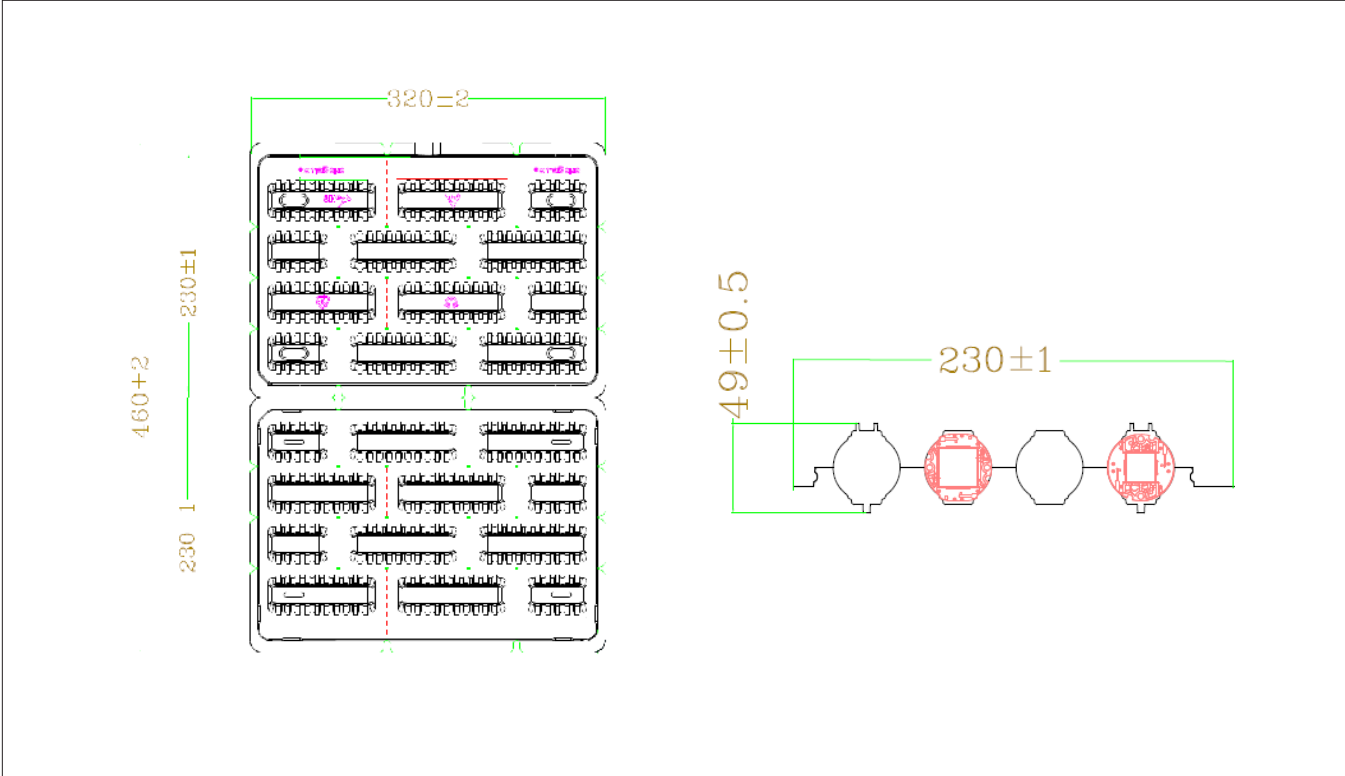

- Notes for Figure 17:
- 1. Dimensions are in millimeters.
 - 2. Drawings are not to scale.

Packaging and Labeling

Figure 18: Vero SE Series Packaging and Labeling

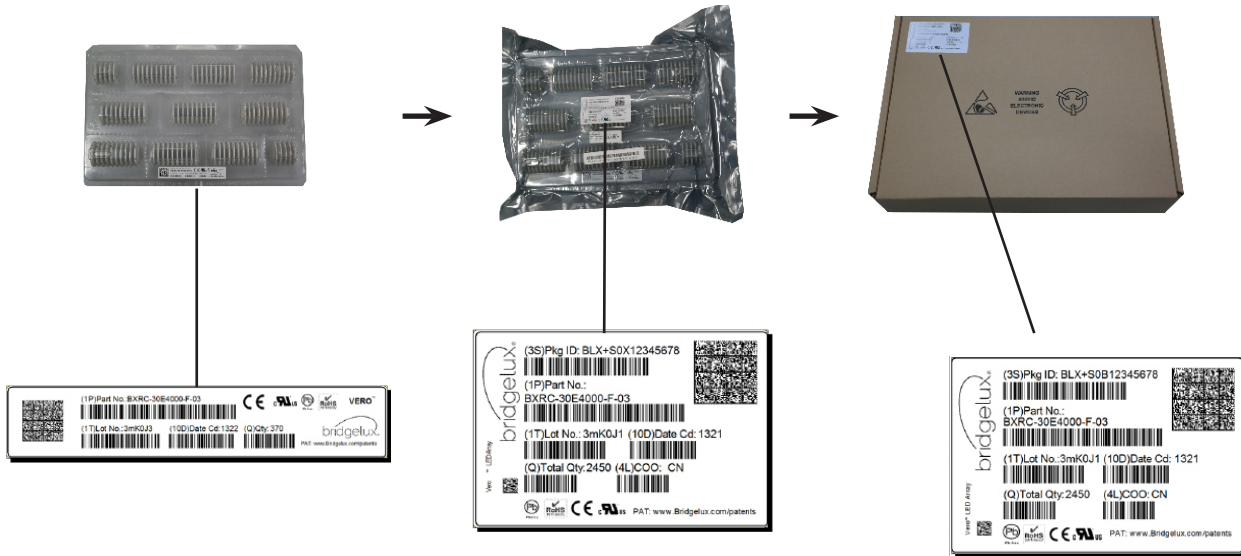

Notes for Figure 18:

1. Each tray holds 100 COBs.
2. Each tray is vacuum sealed in an anti-static bag and placed in its own box.
3. Each tray, bag and box is to be labeled as shown above.

Figure 19: Vero SE Product Labeling

Bridgelux COB arrays have laser markings on the back side of the substrate to help with product identification. In addition to the product identification markings, Bridgelux COB arrays also contain markings for internal Bridgelux manufacturing use only. The image below shows which markings are for customer use and which ones are for Bridgelux internal use only. The Bridgelux internal manufacturing markings are subject to change without notice, however these will not impact the form, function or performance of the COB array.



Customer Use- 2D Barcode
Scannable barcode provides product part number and other Bridgelux internal production information.

Customer Use- Product part number

30E4000C 83 2F

Customer Use- V_f Bin Code
included to enable greater luminaire design flexibility. Refer to ANg2 for bin definitions.

Design Resources

Application Notes

Bridgelux has developed a comprehensive set of application notes and design resources to assist customers in successfully designing with the Vero product family of LED array products. For all available application notes visit www.bridgelux.com.

Optical Source Models

Optical source models and ray set files are available for all Bridgelux products. For a list of available formats, visit www.bridgelux.com.

3D CAD Models

Three dimensional CAD models depicting the product outline of all Bridgelux Vero LED arrays are available in both IGS and STEP formats. Please contact your Bridgelux sales representative for assistance.

LM80

LM80 testing has been completed and the LM80 report is now available. Please contact your Bridgelux sales representative for LM-80 report.

Precautions

CAUTION: CHEMICAL EXPOSURE HAZARD

Exposure to some chemicals commonly used in luminaire manufacturing and assembly can cause damage to the LED array. Please consult Bridgelux Application Note AN121 for additional information.

CAUTION: RISK OF BURN

Do not touch the Vero LED array during operation. Allow the array to cool for a sufficient period of time before handling. The Vero LED array may reach elevated temperatures such that could burn skin when touched.

CAUTION

CONTACT WITH LIGHT EMITTING SURFACE (LES)

Avoid any contact with the LES. Do not touch the LES of the LED array or apply stress to the LES (yellow phosphor resin area). Contact may cause damage to the LED array.

Optics and reflectors must not be mounted in contact with the LES (yellow phosphor resin area). Optical devices may be mounted on the top surface of the plastic housing of the Vero LED array. Use the mechanical features of the LED array housing, edges and/or mounting holes to locate and secure optical devices as needed.

Disclaimers

MINOR PRODUCT CHANGE POLICY

The rigorous qualification testing on products offered by Bridgelux provides performance assurance. Slight cosmetic changes that do not affect form, fit, or function may occur as Bridgelux continues product optimization.

STANDARD TEST CONDITIONS

Unless otherwise stated, array testing is performed at the nominal drive current.

About Bridgelux: Bridging Light and Life™

At Bridgelux, we help companies, industries and people experience the power and possibility of light. Since 2002, we've designed LED solutions that are high performing, energy efficient, cost effective and easy to integrate. Our focus is on light's impact on human behavior, delivering products that create better environments, experiences and returns—both experiential and financial. And our patented technology drives new platforms for commercial and industrial luminaires.

For more information about the company, please visit
bridgelux.com
twitter.com/Bridgelux
facebook.com/Bridgelux
youtube.com/user/Bridgelux
linkedin.com/company/bridgelux-inc-_2
WeChat ID: BridgeluxInChina



46430 Fremont Boulevard
Fremont, CA 94538 U.S.A.
Tel (925) 583-8400
www.bridgelux.com

© 2020 Bridgelux, Inc. All rights reserved. Product specifications are subject to change without notice. Bridgelux, the Bridgelux stylized logo design, Vero, V Series and V Series HD are registered trademarks, and Decor Series is a trademark of Bridgelux, Inc. All other trademarks are the property of their respective owners.

Bridgelux Gen 8 Vero SE 18 Array Series Product Data Sheet DS432 Rev. A (06/2020)