

0.5A/1A PWM/VFM Step-down DC/DC Converter with Synchronous Rectifier

No. EA-362-231212

OUTLINE

The RP509x is a low supply current PWM/VFM step-down DC/DC converter with synchronous rectifier featuring 0.5 A/1 A output current⁽¹⁾. Internally, a single converter consists of a reference voltage unit, an error amplifier, a switching control circuit, a mode control circuit, a soft-start circuit, an undervoltage lockout (UVLO) circuit, a thermal shutdown circuit, and switching transistors. The RP509x is employing synchronous rectification for improving the efficiency of rectification by replacing diodes with built-in switching transistors. Using synchronous rectification not only increases circuit performance but also allows a design to reduce parts count. Output voltage controlling method is selectable between a PWM/VFM auto-switching control type and a forced PWM control type, which further reduces noise than a normal PWM control under a light load, and these types can be set by the MODE pin. Output voltage type is selectable between an internally fixed output voltage type and an externally adjustable output voltage type. Protection circuits in the RP509x is current limit circuit and thermal shutdown circuit. LX current limit value (Typ.) is selectable between 1.6 A and 1.0 A. The RP509Z is available in WLCSP-6-P6 which achieves high-density mounting on boards. Using capacitor of 0402-/1005-size (inch/mm) and inductor of 0603-/1608-size (inch/mm) as external parts help to save space for devices. The RP509N is available in SOT-23-6.

FEATURES

- Input Voltage Range (Maximum Rating) 2.3 V to 5.5 V (6.5 V)
- Output Voltage Range (Fixed Output Voltage Type) 0.6 V to 3.3 V, settable in 0.1 V steps
(Adjustable Output Voltage Type) 0.6 V to 5.5 V
- Output Voltage Accuracy (Fixed Output Voltage Type) $\pm 1.5\%$ ($V_{SET}^{(2)} \geq 1.2$ V), ± 18 mV ($V_{SET} < 1.2$ V)
- Feedback Voltage Accuracy (Adjustable Output Voltage Type) ± 9 mV ($V_{FB} = 0.6$ V)
- Output Voltage/Feedback Voltage Temperature Coefficient ± 100 ppm/ $^{\circ}$ C
- Selectable Oscillator Frequency Typ. 6.0 MHz
- Oscillator Maximum Duty Min. 100%
- Built-in Driver ON Resistance ($V_{IN} = 3.6$ V) Typ. Pch. 0.175 Ω , Nch. 0.155 Ω (RP509Z)
Typ. Pch. 0.195 Ω , Nch. 0.175 Ω (RP509N)
- Standby Current Typ. 0 μ A
- UVLO Detector Threshold Typ. 2.0 V
- Soft-start Time Typ. 0.15 ms
- Inductor Current Limit Circuit Typ. 1.6 A/1.0 A, selectable Current Limit
- Package WLCSP-6-P6 (1.28 mm x 0.88 mm x 0.69 mm)
SOT-23-6 (2.9 mm x 2.8 mm x 1.1 mm)

⁽¹⁾ This is an approximate value. The output current is dependent on conditions and external components.

⁽²⁾ V_{SET} = Set Output Voltage

APPLICATIONS

- Portable Communication Equipment: Mobiles/Smartphones, Digital Cameras and Note-PCs
- Li-ion Battery-used Equipment

SELECTION GUIDE

The set output voltage, the output voltage type, the auto-discharge function⁽¹⁾, and the LX current limit for the ICs are user-selectable options.

Selection Guide

Product Name	Package	Quantity per Reel	Pb Free	Halogen Free
RP509ZxxX\$-E2-F	WLCSP-6-P6	5,000 pcs	Yes	Yes
RP509NxxX\$-TR-FE	SOT-23-6	3,000 pcs	Yes	Yes

xx: Specify the set output voltage (V_{SET})

Fixed Output Voltage Type: 06 to 33 (0.6 V to 3.3 V, 0.1 V steps)

The voltage in 0.05 V step is shown as follows.

1.05 V: RP509Z101B5

1.15 V: RP509N111x5

Adjustable Output Voltage Type: 00 only

X: Specify the LX Current Limit (I_{LXLIM})

Typ. 1.6 A: 1

Typ. 1.0 A: 2

\$. Specify the version

Version	Output Voltage Type	Auto-discharge	Oscillator Frequency	V_{SET}
A	Fixed	No	6.0 MHz	0.6 V to 3.3 V
B		Yes		
C	Adjustable	No		0.6 V to 5.5 V
D		Yes		

⁽¹⁾ Auto-discharge function quickly lowers the output voltage to 0 V, when the chip enable signal is switched from the active mode to the standby mode, by releasing the electrical charge accumulated in the external capacitor.

BLOCK DIAGRAM

RP509ZxxXA/RP509ZxxXB, RP509NxxXA/RP509NxxXB (Fixed Output Voltage Type)

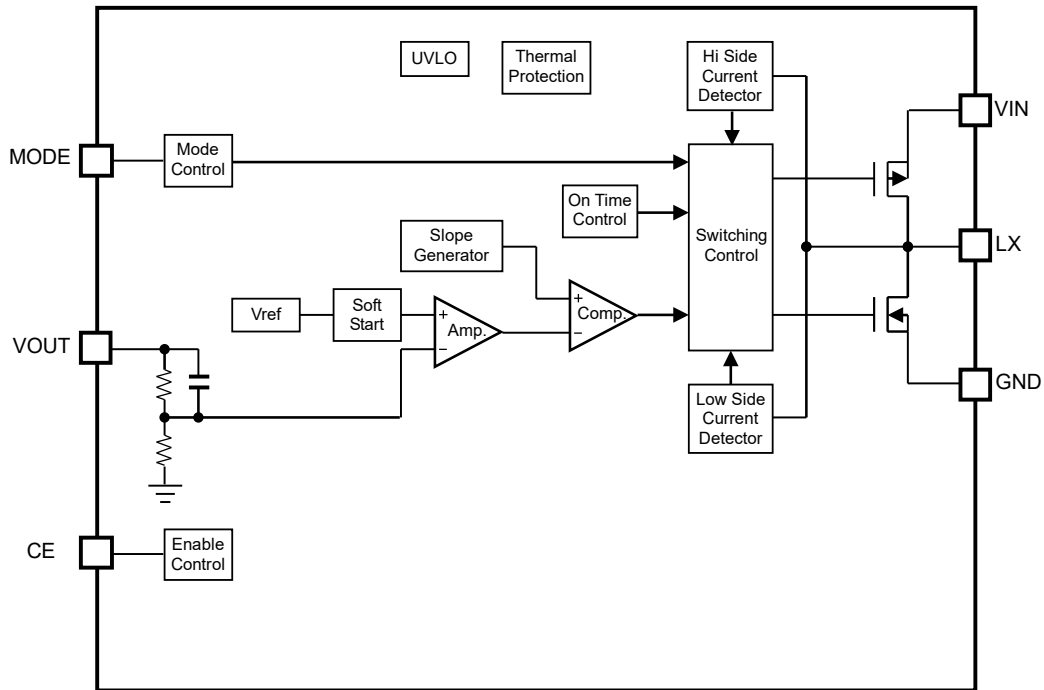

RP509xxxXA Block Diagram

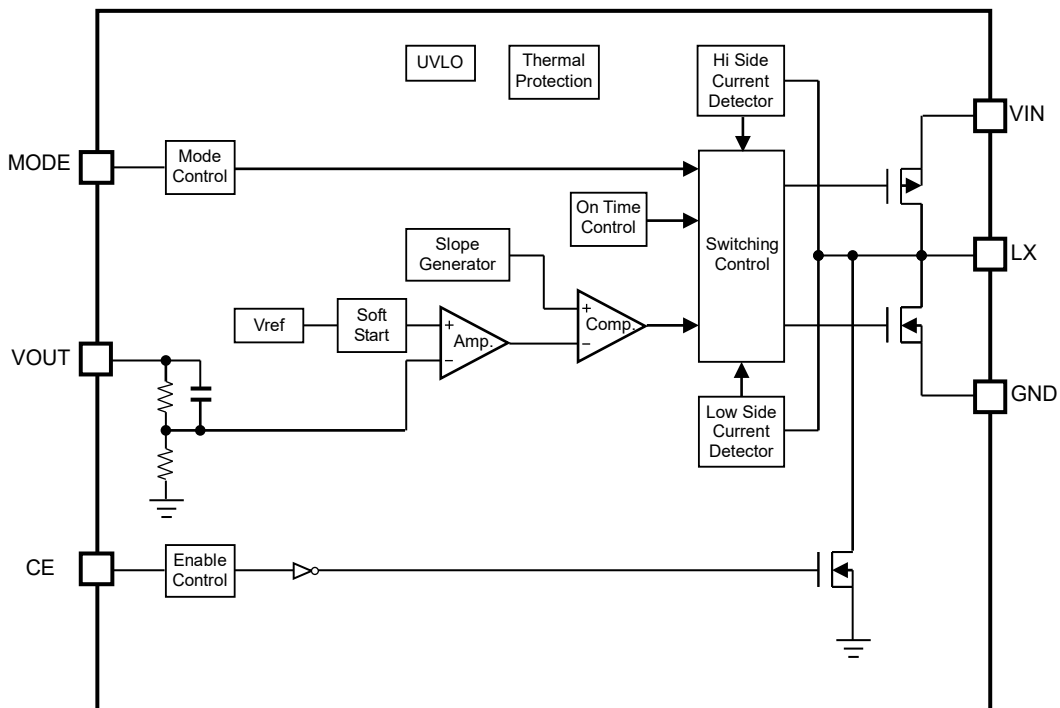

RP509xxxXB Block Diagram

RP509Z00XC/RP509Z00XD, RP509N00XC/RP509N00XD (Adjustable Output Voltage Type)

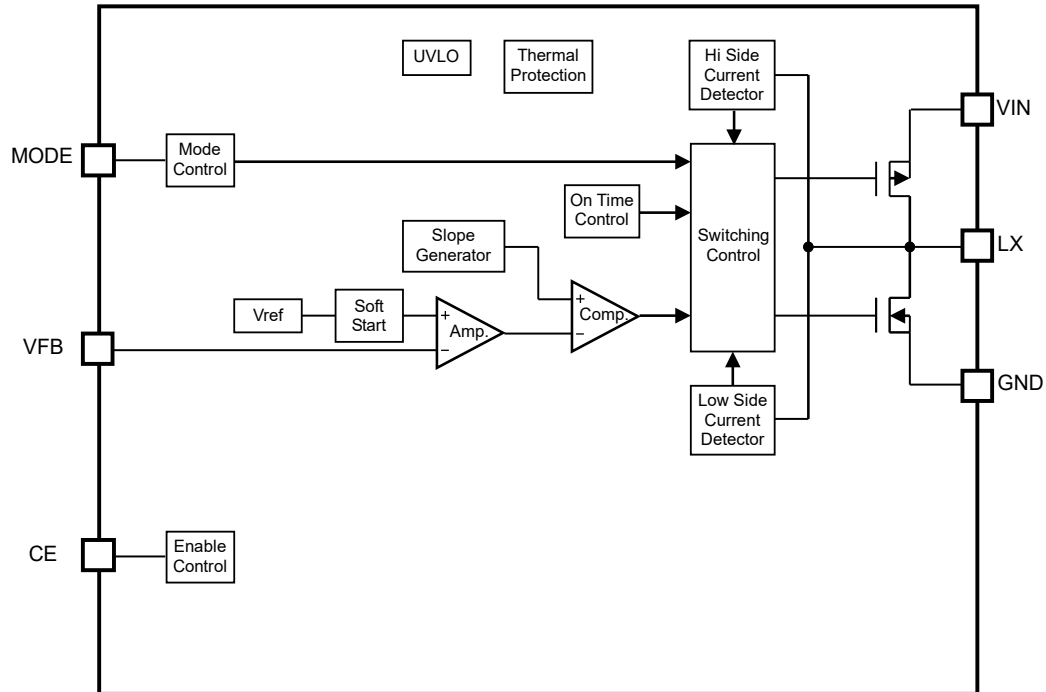

RP509x00XC Block Diagram

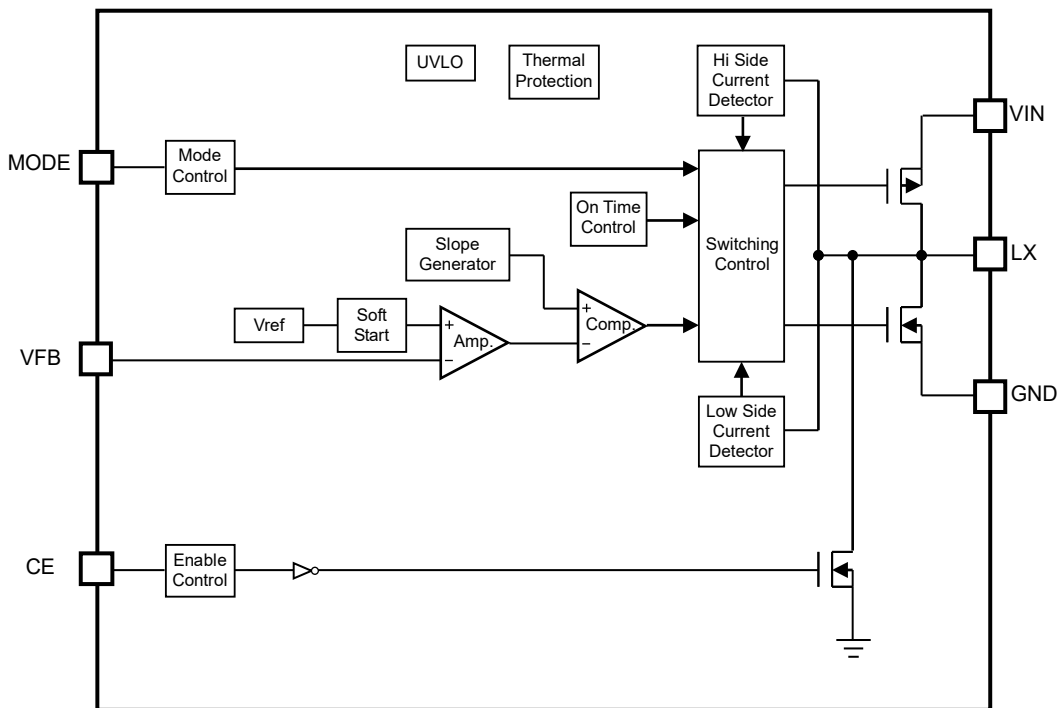

RP509x00XD Block Diagram

PIN DESCRIPTION

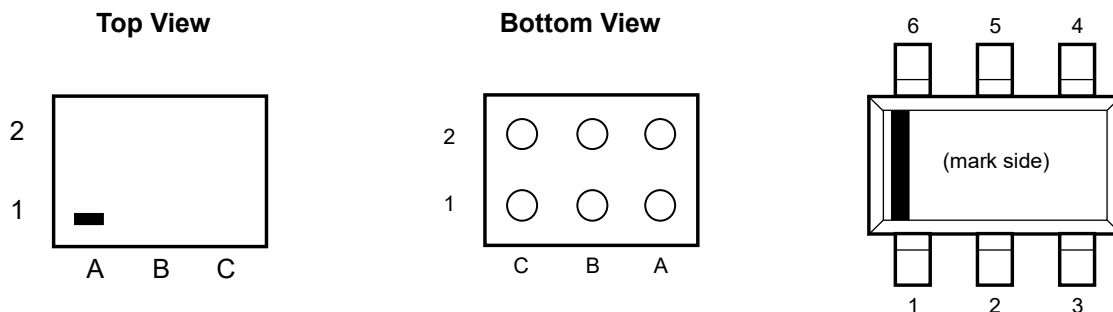

WLCSP-6 Pin Configurations

SOT-23-6 Pin Configurations

WLCSP-6 Pin Description

Pin No.	Symbol	Description
A1	MODE	Mode Control Pin (High: Forced PWM Control, Low: PWM/VFM Auto-switching Control)
B1	LX	Switching Pin
C1	VOUT/VFB	Output/Feedback Voltage Pin
A2	VIN	Input Voltage Pin
B2	CE	Chip Enable Pin, Active-high
C2	GND	Ground Pin

SOT-23-6 Pin Description

Pin No.	Symbol	Description
1	CE	Chip Enable Pin, Active-high
2	GND	Ground Pin
3	VIN	Input Voltage Pin
4	MODE	Mode Control Pin (High: Forced PWM Control, Low: PWM/VFM Auto-switching Control)
5	LX	Switching Pin
6	VOUT/VFB	Output/Feedback Voltage Pin

ABSOLUTE MAXIMUM RATINGS

Absolute Maximum Ratings (GND = 0 V)

Symbol	Item		Rating	Unit	
V_{IN}	Input Voltage		-0.3 to 6.5	V	
V_{LX}	LX Pin Voltage		-0.3 to $V_{IN} + 0.3$	V	
V_{CE}	CE Pin Voltage		-0.3 to 6.5	V	
V_{MODE}	MODE Pin Voltage		-0.3 to 6.5	V	
V_{OUT}/V_{FB}	VOUT/VFB Pin Voltage		-0.3 to 6.5	V	
I_{LX}	LX Pin Output Current		1.6	A	
P_D	Power Dissipation ⁽¹⁾	WLCSP6-P6	JEDEC STD. 51-9 Test Land Pattern	910	mW
		SOT-23-6	JEDEC STD. 51-7 Test Land Pattern	892	mW
T_j	Junction Temperature		-40 to 125	°C	
T_{stg}	Storage Temperature Range		-55 to 125	°C	

ABSOLUTE MAXIMUM RATINGS

Electronic and mechanical stress momentarily exceeded absolute maximum ratings may cause the permanent damages and may degrade the lifetime and safety for both device and system using the device in the field. The functional operation at or over these absolute maximum ratings is not assured.

RECOMMENDED OPERATING CONDITIONS

Symbol	Item	Rating	Unit
V_{IN}	Input Voltage	2.3 to 5.5	V
T_a	Operating Temperature Range	-40 to 85	°C

RECOMMENDED OPERATING CONDITIONS

All of electronic equipment should be designed that the mounted semiconductor devices operate within the recommended operating conditions. The semiconductor devices cannot operate normally over the recommended operating conditions, even if when they are used over such conditions by momentary electronic noise or surge. And the semiconductor devices may receive serious damage when they continue to operate over the recommended operating conditions.

⁽¹⁾ Refer to *POWER DISSIPATION* for detailed information.

ELECTRICAL CHARACTERISTICS

Test circuit is operated with "Open Loop Control" (GND = 0 V), unless otherwise specified.

RP509Zxx1A/RP509Zxx1B, RP509Nxx1A/RP509Nxx1B Electrical Characteristics (Ta = 25°C)

Symbol	Item	Conditions	Min.	Typ.	Max.	Unit	
V _{OUT}	Output Voltage	V _{IN} = V _{CE} = 3.6 V (V _{SET} ≤ 2.6 V), V _{IN} = V _{CE} = V _{SET} + 1 V (V _{SET} > 2.6 V)	V _{SET} ≥ 1.2 V	x 0.985	x 1.015	V	
		V _{SET} < 1.2 V	-0.018		+0.018		
ΔV _{OUT} /ΔTa	Output Voltage Temperature Coefficient	-40 °C ≤ Ta ≤ 85 °C		±100		ppm/°C	
f _{OSC}	Oscillator Frequency	V _{IN} = V _{CE} = 3.6 V, V _{SET} = 1.8 V, "Closed Loop Control"	4.8	6.0	7.2	MHz	
I _{DD}	Supply Current	V _{IN} = V _{CE} = V _{OUT} = 3.6 V, V _{MODE} = 0 V		15		μA	
I _{STANDBY}	Standby Current	V _{IN} = 5.5 V, V _{CE} = 0 V		0	5	μA	
I _{CEH}	CE "High" Input Current	V _{IN} = V _{CE} = 5.5 V	-1	0	1	μA	
I _{CEL}	CE "Low" Input Current	V _{IN} = 5.5 V, V _{CE} = 0 V	-1	0	1	μA	
I _{MODEH}	MODE "High" Input Current	V _{IN} = V _{MODE} = 5.5 V, V _{CE} = 0 V	-1	0	1	μA	
I _{MODEL}	MODE "Low" Input Current	V _{IN} = 5.5 V, V _{CE} = V _{MODE} = 0 V	-1	0	1	μA	
I _{VOUTH}	V _{OUT} "High" Input Current	V _{IN} = V _{OUT} = 5.5 V, V _{CE} = 0 V	-1	0	1	μA	
I _{VOUTL}	V _{OUT} "Low" Input Current	V _{IN} = 5.5 V, V _{CE} = V _{OUT} = 0 V	-1	0	1	μA	
R _{DISTR}	On-resistance for Auto Discharger ⁽¹⁾	V _{IN} = 3.6 V, V _{CE} = 0 V		40		Ω	
I _{LXLEAKH}	LX "High" Leakage Current	V _{IN} = V _{LX} = 5.5 V, V _{CE} = 0 V	-1	0	5	μA	
I _{LXLEAKL}	LX "Low" Leakage Current	V _{IN} = 5.5 V, V _{CE} = V _{LX} = 0 V	-5	0	1	μA	
V _{CEH}	CE "High" Input Voltage	V _{IN} = 5.5 V	1.0			V	
V _{CEL}	CE "Low" Input Voltage	V _{IN} = 2.3 V			0.4	V	
V _{MODEH}	MODE "High" Input Voltage	V _{IN} = V _{CE} = 5.5 V	1.0			V	
V _{MODEL}	MODE "Low" Input Voltage	V _{IN} = V _{CE} = 2.3 V			0.4	V	
R _{ONP}	On-resistance of Pch. transistor	RP509Z	V _{IN} = 3.6 V, I _{LX} = -100 mA		0.175		Ω
		RP509N			0.195		Ω
R _{ONN}	On-resistance of Nch. transistor	RP509Z	V _{IN} = 3.6 V, I _{LX} = -100 mA		0.155		Ω
		RP509N			0.175		Ω
Maxduty	Maximum Duty Cycle		100			%	
t _{START}	Soft-start Time	V _{IN} = V _{CE} = 3.6 V (V _{SET} ≤ 2.6 V), V _{IN} = V _{CE} = V _{SET} + 1 V (V _{SET} > 2.6 V)		150	300	μs	
I _{LXLIM}	LX Current Limit	V _{IN} = V _{CE} = 3.6 V (V _{SET} ≤ 2.6 V), V _{IN} = V _{CE} = V _{SET} + 1 V (V _{SET} > 2.6 V)	1200	1600		mA	
V _{UVLO1}	UVLO Threshold Voltage	V _{IN} = V _{CE} , Falling	1.85	2.00	2.20	V	
V _{UVLO2}		V _{IN} = V _{CE} , Rising	1.90	2.05	2.25	V	
T _{TSD}	Thermal Shutdown Threshold Temperature	T _j , Rising		140		°C	
T _{TSR}		T _j , Falling		100		°C	

All test items listed under Electrical Characteristics are done under the pulse load condition (T_j ≈ Ta = 25°C).

⁽¹⁾ RP509xxx1B only

Test circuit is operated with "Open Loop Control" (GND = 0 V), unless otherwise specified.

RP509Z001C/RP509Z001D, RP509N001C/RP509N001D Electrical Characteristics (Ta = 25°C)

Symbol	Item	Conditions	Min.	Typ.	Max.	Unit	
V _{FB}	Feedback Voltage	V _{IN} = V _{CE} = 3.6 V	0.591	0.600	0.609	V	
ΔV _{FB} /ΔTa	Feedback Voltage Temperature Coefficient	-40 °C ≤ Ta ≤ 85 °C		±100		ppm/°C	
f _{OSC}	Oscillator Frequency	V _{IN} = V _{CE} = 3.6 V, V _{SET} = 1.8 V, "Closed Loop Control"	4.8	6.0	7.2	MHz	
I _{DD}	Supply Current	V _{IN} = V _{CE} = V _{OUT} = 3.6V, V _{MODE} = 0V		15		μA	
I _{STANDBY}	Standby Current	V _{IN} = 5.5 V, V _{CE} = 0 V		0	5	μA	
I _{CEH}	CE "High" Input Current	V _{IN} = V _{CE} = 5.5 V	-1	0	1	μA	
I _{CEL}	CE "Low" Input Current	V _{IN} = 5.5 V, V _{CE} = 0 V	-1	0	1	μA	
I _{MODEH}	MODE "High" Input Current	V _{IN} = V _{MODE} = 5.5 V, V _{CE} = 0 V	-1	0	1	μA	
I _{MODEL}	MODE "Low" Input Current	V _{IN} = 5.5 V, V _{CE} = V _{MODE} = 0 V	-1	0	1	μA	
I _{VOUTH}	V _{OUT} "High" Input Current	V _{IN} = V _{OUT} = 5.5 V, V _{CE} = 0 V	-1	0	1	μA	
I _{VOUTL}	V _{OUT} "Low" Input Current	V _{IN} = 5.5 V, V _{CE} = V _{OUT} = 0 V	-1	0	1	μA	
R _{DISTR}	On-resistance for Auto Discharge ⁽¹⁾	V _{IN} = 3.6 V, V _{CE} = 0 V		40		Ω	
I _{LXLEAKH}	LX "High" Leakage Current	V _{IN} = V _{LX} = 5.5 V, V _{CE} = 0 V	-1	0	5	μA	
I _{LXLEAKL}	LX "Low" Leakage Current	V _{IN} = 5.5 V, V _{CE} = V _{LX} = 0 V	-5	0	1	μA	
V _{CEH}	CE "High" Input Voltage	V _{IN} = 5.5 V	1.0			V	
V _{CEL}	CE "Low" Input Voltage	V _{IN} = 2.3 V			0.4	V	
V _{MODEH}	MODE "High" Input Voltage	V _{IN} = V _{CE} = 5.5 V	1.0			V	
V _{MODEL}	MODE "Low" Input Voltage	V _{IN} = V _{CE} = 2.3 V			0.4	V	
R _{ONP}	On-resistance of Pch. Transistor	RP509Z	V _{IN} = 3.6 V, I _{LX} = -100 mA		0.175		Ω
		RP509N			0.195		Ω
R _{ONN}	On-resistance of Nch. Transistor	RP509Z	V _{IN} = 3.6 V, I _{LX} = -100 mA		0.155		Ω
		RP509N			0.175		Ω
Maxduty	Maximum Duty Cycle		100			%	
t _{START}	Soft-start Time	V _{IN} = V _{CE} = 3.6 V (V _{SET} ≤ 2.6 V), V _{IN} = V _{CE} = V _{SET} + 1 V (V _{SET} > 2.6 V)		150	300	μs	
I _{LXLIM}	LX Current Limit	V _{IN} = V _{CE} = 3.6 V (V _{SET} ≤ 2.6 V), V _{IN} = V _{CE} = V _{SET} + 1 V (V _{SET} > 2.6 V)	1200	1600		mA	
V _{UVLO1}	UVLO Threshold Voltage	V _{IN} = V _{CE} , Falling	1.85	2.00	2.20	V	
V _{UVLO2}		V _{IN} = V _{CE} , Rising	1.90	2.05	2.25	V	
T _{TSD}	Thermal Shutdown Threshold Temperature	T _j , Rising		140		°C	
T _{TSR}		T _j , Falling		100		°C	

All test items listed under Electrical Characteristics are done under the pulse load condition (T_j ≈ Ta = 25°C).

⁽¹⁾ RP509x001D only

Test circuit is operated with "Open Loop Control" (GND = 0 V), unless otherwise specified.

RP509Zxx2A/RP509Zxx2B, RP509Nxx2A/RP509Nxx2B Electrical Characteristics (Ta = 25°C)

Symbol	Item	Conditions	Min.	Typ.	Max.	Unit
V _{OUT}	Output Voltage	V _{IN} = V _{CE} = 3.6 V (V _{SET} ≤ 2.6 V), V _{IN} = V _{CE} = V _{SET} + 1 V (V _{SET} > 2.6 V)	V _{SET} ≥ 1.2 V	x 0.985	x 1.015	V
			V _{SET} < 1.2 V	-0.018	+0.018	
ΔV _{OUT} /ΔTa	Output Voltage Temperature Coefficient	-40 °C ≤ Ta ≤ 85 °C		±100		ppm/°C
f _{OSC}	Oscillator Frequency	V _{IN} = V _{CE} = 3.6 V, V _{SET} = 1.8 V, "Closed Loop Control"	4.8	6.0	7.2	MHz
I _{DD}	Supply Current	V _{IN} = V _{CE} = V _{OUT} = 3.6V, V _{MODE} = 0V		15		μA
I _{STANDBY}	Standby Current	V _{IN} = 5.5 V, V _{CE} = 0 V		0	5	μA
I _{CEH}	CE "High" Input Current	V _{IN} = V _{CE} = 5.5 V	-1	0	1	μA
I _{CEL}	CE "Low" Input Current	V _{IN} = 5.5 V, V _{CE} = 0 V	-1	0	1	μA
I _{MODEH}	MODE "High" Input Current	V _{IN} = V _{MODE} = 5.5 V, V _{CE} = 0 V	-1	0	1	μA
I _{MODEL}	MODE "Low" Input Current	V _{IN} = 5.5 V, V _{CE} = V _{MODE} = 0 V	-1	0	1	μA
I _{VOUTH}	V _{OUT} "High" Input Current	V _{IN} = V _{OUT} = 5.5 V, V _{CE} = 0 V	-1	0	1	μA
I _{VOUTL}	V _{OUT} "Low" Input Current	V _{IN} = 5.5 V, V _{CE} = V _{OUT} = 0 V	-1	0	1	μA
R _{DISTR}	On-resistance for Auto Discharger ⁽¹⁾	V _{IN} = 3.6 V, V _{CE} = 0 V		40		Ω
I _{LXLEAKH}	LX "High" Leakage Current	V _{IN} = V _{LX} = 5.5 V, V _{CE} = 0 V	-1	0	5	μA
I _{LXLEAKL}	LX "Low" Leakage Current	V _{IN} = 5.5 V, V _{CE} = V _{LX} = 0 V	-5	0	1	μA
V _{CEH}	CE "High" Input Voltage	V _{IN} = 5.5 V	1.0			V
V _{CEL}	CE "Low" Input Voltage	V _{IN} = 2.3 V			0.4	V
V _{MODEH}	MODE "High" Input Voltage	V _{IN} = V _{CE} = 5.5 V	1.0			V
V _{MODEL}	MODE "Low" Input Voltage	V _{IN} = V _{CE} = 2.3 V			0.4	V
R _{ONP}	On-resistance of Pch. transistor	RP509Z	V _{IN} = 3.6 V, I _{LX} = -100 mA		0.175	Ω
		RP509N			0.195	Ω
R _{ONN}	On-resistance of Nch. transistor	RP509Z	V _{IN} = 3.6 V, I _{LX} = -100 mA		0.155	Ω
		RP509N			0.175	Ω
Maxduty	Maximum Duty Cycle		100			%
t _{START}	Soft-start Time	V _{IN} = V _{CE} = 3.6 V (V _{SET} ≤ 2.6 V), V _{IN} = V _{CE} = V _{SET} + 1 V (V _{SET} > 2.6 V)		150	300	μs
I _{LXLIM}	LX Current Limit	V _{IN} = V _{CE} = 3.6 V (V _{SET} ≤ 2.6 V), V _{IN} = V _{CE} = V _{SET} + 1 V (V _{SET} > 2.6 V)	600	1000		mA
V _{UVLO1}	UVLO Threshold Voltage	V _{IN} = V _{CE} , Falling	1.85	2.00	2.20	V
V _{UVLO2}		V _{IN} = V _{CE} , Rising	1.90	2.05	2.25	V
T _{TSD}	Thermal Shutdown Threshold Temperature	T _j , Rising		140		°C
T _{TSR}		T _j , Falling		100		°C

All test items listed under Electrical Characteristics are done under the pulse load condition (T_j ≈ Ta = 25°C).

⁽¹⁾ RP509xxx2B only

Test circuit is operated with "Open Loop Control" (GND = 0 V), unless otherwise specified.

RP509Z002C/RP509Z002D, RP509N002C/RP509N002D Electrical Characteristics (Ta = 25°C)

Symbol	Item	Conditions	Min.	Typ.	Max.	Unit
V _{FB}	Feedback Voltage	V _{IN} = V _{CE} = 3.6 V	0.591	0.600	0.609	V
ΔV _{FB} /ΔTa	Feedback Voltage Temperature Coefficient	-40 °C ≤ Ta ≤ 85 °C		±100		ppm/°C
f _{OSC}	Oscillator Frequency	V _{IN} = V _{CE} = 3.6 V, V _{SET} = 1.8 V, "Closed Loop Control"	4.8	6.0	7.2	MHz
I _{DD}	Supply Current	V _{IN} = V _{CE} = V _{OUT} = 3.6 V, V _{MODE} = 0 V		15		μA
I _{STANDBY}	Standby Current	V _{IN} = 5.5 V, V _{CE} = 0 V		0	5	μA
I _{CEH}	CE "High" Input Current	V _{IN} = V _{CE} = 5.5 V	-1	0	1	μA
I _{CEL}	CE "Low" Input Current	V _{IN} = 5.5 V, V _{CE} = 0 V	-1	0	1	μA
I _{MODEH}	MODE "High" Input Current	V _{IN} = V _{MODE} = 5.5 V, V _{CE} = 0 V	-1	0	1	μA
I _{MODEL}	MODE "Low" Input Current	V _{IN} = 5.5 V, V _{CE} = V _{MODE} = 0 V	-1	0	1	μA
I _{VOUTH}	V _{OUT} "High" Input Current	V _{IN} = V _{OUT} = 5.5 V, V _{CE} = 0 V	-1	0	1	μA
I _{VOUTL}	V _{OUT} "Low" Input Current	V _{IN} = 5.5 V, V _{CE} = V _{OUT} = 0 V	-1	0	1	μA
R _{DISTR}	On-resistance for Auto Discharge ⁽¹⁾	V _{IN} = 3.6 V, V _{CE} = 0 V		40		Ω
I _{LXLEAKH}	LX "High" Leakage Current	V _{IN} = V _{LX} = 5.5 V, V _{CE} = 0 V	-1	0	5	μA
I _{LXLEAKL}	LX "Low" Leakage Current	V _{IN} = 5.5 V, V _{CE} = V _{LX} = 0 V	-5	0	1	μA
V _{CEH}	CE "High" Input Voltage	V _{IN} = 5.5 V	1.0			V
V _{CEL}	CE "Low" Input Voltage	V _{IN} = 2.3 V			0.4	V
V _{MODEH}	MODE "High" Input Voltage	V _{IN} = V _{CE} = 5.5 V	1.0			V
V _{MODEL}	MODE "Low" Input Voltage	V _{IN} = V _{CE} = 2.3 V			0.4	V
R _{ONP}	On-resistance of Pch. Transistor	RP509Z	V _{IN} = 3.6 V, I _{LX} = -100 mA	0.175		Ω
		RP509N		0.195		Ω
R _{ONN}	On-resistance of Nch. Transistor	RP509Z	V _{IN} = 3.6 V, I _{LX} = -100 mA	0.155		Ω
		RP509N		0.175		Ω
Maxduty	Maximum Duty Cycle		100			%
t _{START}	Soft-start Time	V _{IN} = V _{CE} = 3.6 V (V _{SET} ≤ 2.6 V), V _{IN} = V _{CE} = V _{SET} + 1 V (V _{SET} > 2.6 V)		150	300	μs
I _{LXLIM}	LX Current Limit	V _{IN} = V _{CE} = 3.6 V (V _{SET} ≤ 2.6 V), V _{IN} = V _{CE} = V _{SET} + 1 V (V _{SET} > 2.6 V)	600	1000		mA
V _{UVLO1}	UVLO Threshold Voltage	V _{IN} = V _{CE} , Falling	1.85	2.00	2.20	V
V _{UVLO2}		V _{IN} = V _{CE} , Rising	1.90	2.05	2.25	V
T _{TSD}	Thermal Shutdown Threshold Temperature	T _j , Rising		140		°C
T _{TSR}		T _j , Falling		100		°C

All test items listed under Electrical Characteristics are done under the pulse load condition (T_j ≈ Ta = 25°C).

⁽¹⁾ RP509x002D only

Electrical Characteristics by Different Output Voltage**RP509ZxxXA/RP509ZxxXB, RP509NxxXA/RP509NxxXB (Fixed Output Voltage Type) (Ta = 25°C)**

製品名		V _{OUT} [V]		
		Min.	Typ.	Max.
RP509x06XA	RP509x06XB	0.582	0.600	0.618
RP509x07XA	RP509x07XB	0.682	0.700	0.718
RP509x08XA	RP509x08XB	0.782	0.800	0.818
RP509x09XA	RP509x09XB	0.882	0.900	0.918
RP509x10XA	RP509x10XB	0.982	1.000	1.018
RP509x11XA	RP509x11XB	1.082	1.100	1.118
RP509x12XA	RP509x12XB	1.182	1.200	1.218
RP509x13XA	RP509x13XB	1.281	1.300	1.319
RP509x14XA	RP509x14XB	1.379	1.400	1.421
RP509x15XA	RP509x15XB	1.478	1.500	1.522
RP509x16XA	RP509x16XB	1.576	1.600	1.624
RP509x17XA	RP509x17XB	1.675	1.700	1.725
RP509x18XA	RP509x18XB	1.773	1.800	1.827
RP509x19XA	RP509x19XB	1.872	1.900	1.928
RP509x20XA	RP509x20XB	1.970	2.000	2.030
RP509x21XA	RP509x21XB	2.069	2.100	2.131
RP509x22XA	RP509x22XB	2.167	2.200	2.233
RP509x23XA	RP509x23XB	2.266	2.300	2.334
RP509x24XA	RP509x24XB	2.364	2.400	2.436
RP509x25XA	RP509x25XB	2.463	2.500	2.537
RP509x26XA	RP509x26XB	2.561	2.600	2.639
RP509x27XA	RP509x27XB	2.660	2.700	2.740
RP509x28XA	RP509x28XB	2.758	2.800	2.842
RP509x29XA	RP509x29XB	2.857	2.900	2.943
RP509x30XA	RP509x30XB	2.955	3.000	3.045
RP509x31XA	RP509x31XB	3.054	3.100	3.146
RP509x32XA	RP509x32XB	3.152	3.200	3.248
RP509x33XA	RP509x33XB	3.251	3.300	3.349
-	RP509Z06XB5	0.632	0.650	0.668
-	RP509Z101B5	1.032	1.050	1.068
RP509N111A5	RP509N111B5	1.132	1.150	1.168
-	RP509Z112B5	1.132	1.150	1.168
-	RP509x13XB5	1.330	1.350	1.370

OPERATING DESCRIPTIONS

Soft-start Time

Starting-up with CE Pin

The IC starts to operate when the CE pin voltage (V_{CE}) exceeds the threshold voltage. The threshold voltage is preset between CE “H” input voltage (V_{CEH}) and CE “Low” input voltage (V_{CEL}).

After the start-of the start-up of the IC, soft-start circuit starts to operate. Then, after a certain period of time, the reference voltage (V_{REF}) in the IC gradually increases up to the specified value.

Notes: Soft start time (t_{START})⁽¹⁾ is not always equal to the turn-on speed of the step-down DC/DC converter. Please note that the turn-on speed could be affected by the power supply capacity, the output current, the inductance value and the C_{OUT} value.

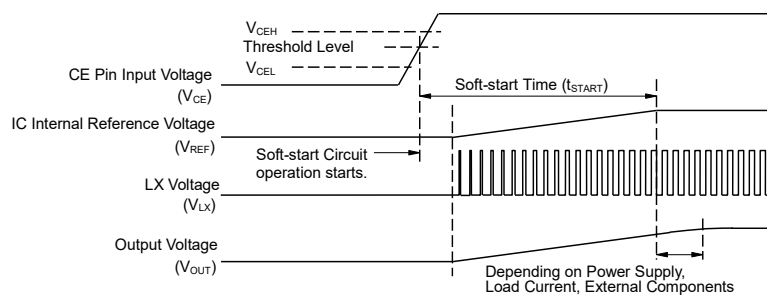

Timing Chart when Starting-up with CE Pin

Starting-up with Power Supply

After the power-on, when V_{IN} exceeds the UVLO released voltage (V_{UVLO2}), the IC starts to operate. Then, soft-start circuit starts to operate and after a certain period of time, V_{REF} gradually increases up to the specified value.

Notes: Please note that the turn-on speed of V_{OUT} could be affected by the power supply capacity, the output current, the inductance value, the C_{OUT} value and the turn-on speed of V_{IN} determined by C_{IN} .

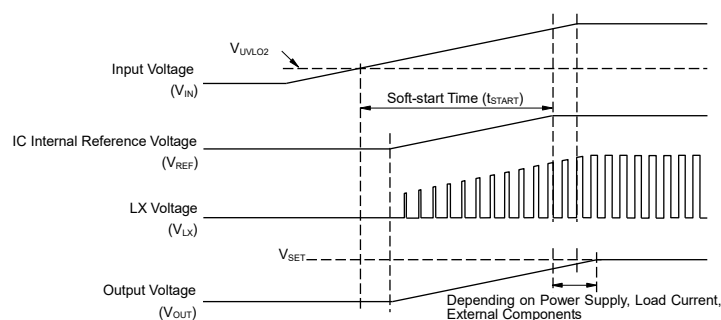

Timing Chart when Starting-up with Power Supply

⁽¹⁾ Soft-start time (t_{START}) indicates the duration until the reference voltage (V_{REF}) reaches the specified voltage after soft-start circuit's activation.

Undervoltage Lockout (UVLO) Circuit

If V_{IN} becomes lower than V_{SET} , the step-down DC/DC converter stops the switching operation and ON duty becomes 100%, and then V_{OUT} gradually drops according to V_{IN} .

If the V_{IN} drops more and becomes lower than the UVLO detector threshold (V_{UVLO1}), the UVLO circuit starts to operate, V_{REF} stops, and Pch. and Nch. built-in switch transistors turn "OFF". As a result, V_{OUT} drops according to the C_{OUT} capacitance value and the load.

To restart the operation, V_{IN} needs to be higher than V_{UVLO2} . The timing chart below shows the voltage shifts of V_{REF} , V_{LX} and V_{OUT} when V_{IN} value is varied.

Notes: Falling edge (operating) and rising edge (releasing) waveforms of V_{OUT} could be affected by the initial voltage of C_{OUT} and the output current of V_{OUT} .

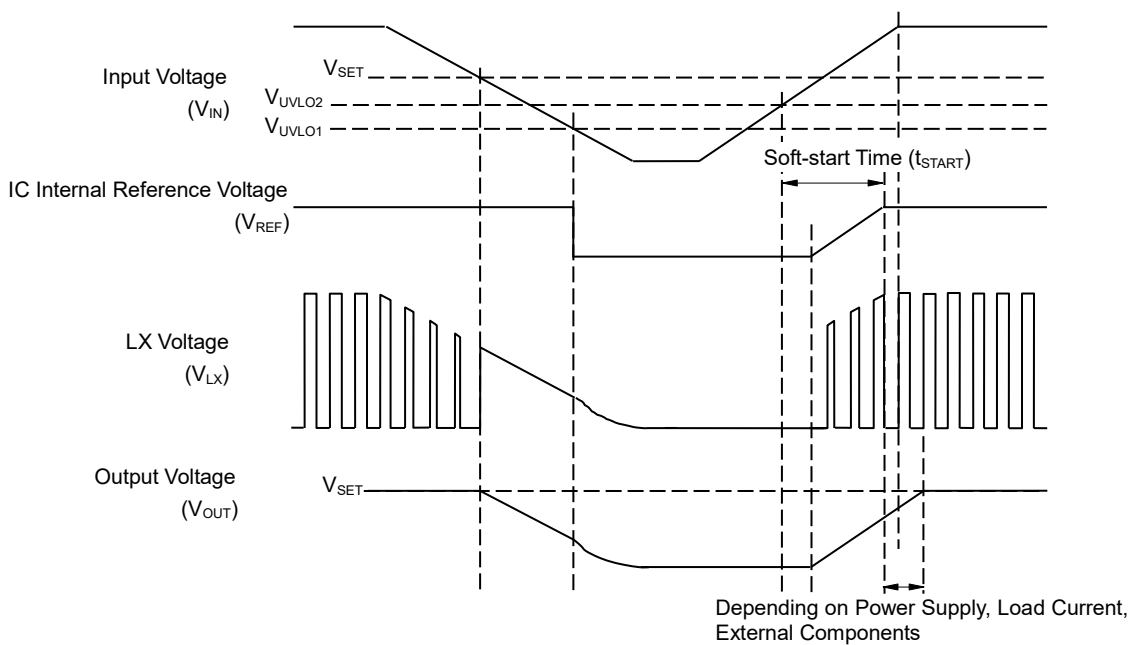

Timing Chart with Variations in Input Voltage (V_{IN})

Current Limit Circuit

Current limit circuit supervises the inductor peak current (the peak current flowing through Pch. Tr.) in each switching cycle, and if the current exceeds the LX current limit (I_{LXLIM}), it turns off Pch. Tr. I_{LXLIM} of the RP509x is set to Typ.1.6 A or Typ.1.0 A.

Notes: I_{LXLIM} could be easily affected by self-heating or ambient environment. If the V_{IN} drops dramatically or becomes unstable due to short-circuit, protection operation could be affected.

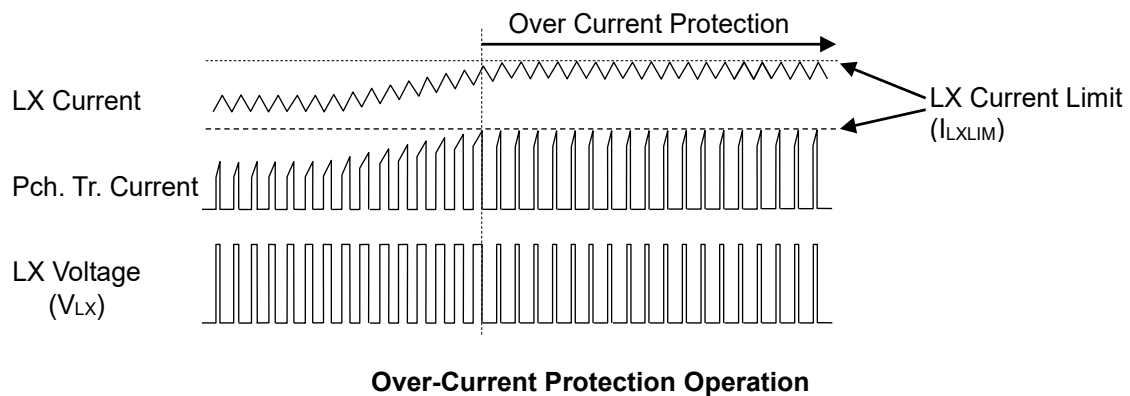

Operation of Step-down DC/DC Converter and Output Current

The step-down DC/DC converter charges energy in the inductor when LX Tr. turns “ON”, and discharges the energy from the inductor when LX Tr. turns “OFF” and controls with less energy loss, so that a lower output voltage (V_{OUT}) than the input voltage (V_{IN}) can be obtained. The operation of the step-down DC/DC converter is explained in the following figures.

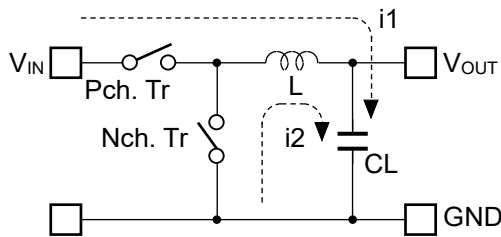

Basic Circuit

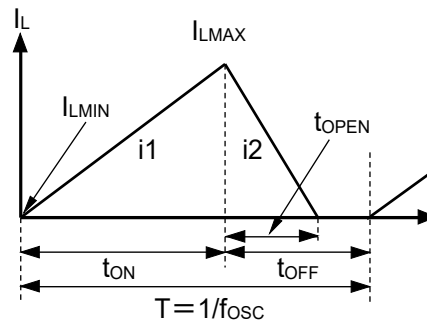

Inductor Current (I_L) flowing through Inductor (L)

- Step1.** Pch. Tr. turns “ON” and I_L ($i1$) flows, L is charged with energy. At this moment, $i1$ increases from the minimum inductor current (I_{LMIN}), which is 0 A, and reaches the maximum inductor current (I_{LMAX}) in proportion to the on-time period (t_{ON}) of Pch. Tr.
- Step2.** When Pch. Tr. turns “OFF”, L tries to maintain I_L at I_{LMAX} , so L turns Nch Tr. “ON” and I_L ($i2$) flows into L.
- Step3.** $i2$ decreases gradually and reaches I_{LMIN} after the open-time period (t_{OPEN}) of Nch. Tr., and then Nch. Tr. turns “OFF”. This is called discontinuous current mode.
As the output current (I_{OUT}) increases, the off-time period (t_{OFF}) of Pch. Tr. runs out before I_L reaches I_{LMIN} . The next cycle starts, and Pch. Tr. turns “ON” and Nch. Tr. turns “OFF”, which means I_L starts increasing from I_{LMIN} . This is called continuous current mode.

In PWM mode, V_{OUT} is maintained by controlling t_{on} . The oscillator frequency (f_{osc}) is maintained constant during PWM mode.

When the step-down DC/DC operation is constant, I_{LMIN} and I_{LMAX} during t_{on} of Pch. Tr. would be same as during t_{off} of Pch. Tr. The current differential between I_{LMAX} and I_{LMIN} is described as ΔI , as the following equation 1.

$$\Delta I = I_{LMAX} - I_{LMIN} = V_{OUT} \times t_{OPEN} / L = (V_{IN} - V_{OUT}) \times t_{ON} / L \dots \dots \dots \text{Equation 1}$$

The above equation is predicated on the following requirements.

$$T = 1 / f_{OSC} = t_{ON} + t_{OFF}$$

$$\text{duty (\%)} = t_{ON} / T \times 100 = t_{ON} \times f_{OSC} \times 100$$

$$t_{OPEN} \leq t_{OFF}$$

In Equation 1, “ $V_{OUT} \times t_{OPEN} / L$ ” shows the amount of current change in “OFF” state. Also, “ $(V_{IN} - V_{OUT}) \times t_{ON} / L$ ” shows the amount of current change at “ON” state.

Discontinuous Mode and Continuous Mode

As illustrated in Figure A., when I_{OUT} is relatively small, $t_{OPEN} < t_{OFF}$. In this case, the energy charged into L during t_{ON} will be completely discharged during t_{OFF} , as a result, $I_{LMIN} = 0$. This is called discontinuous mode. When I_{OUT} is gradually increased, eventually $t_{OPEN} = t_{OFF}$ and when I_{OUT} is increased further, eventually $I_{LMIN} > 0$ as illustrated in Figure B. This is called continuous mode.

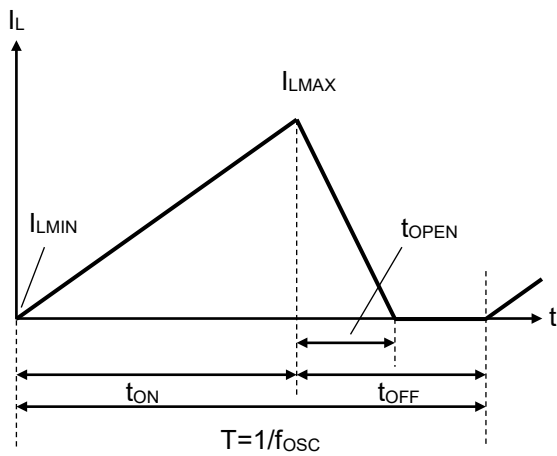

Figure A. Discontinuous Mode

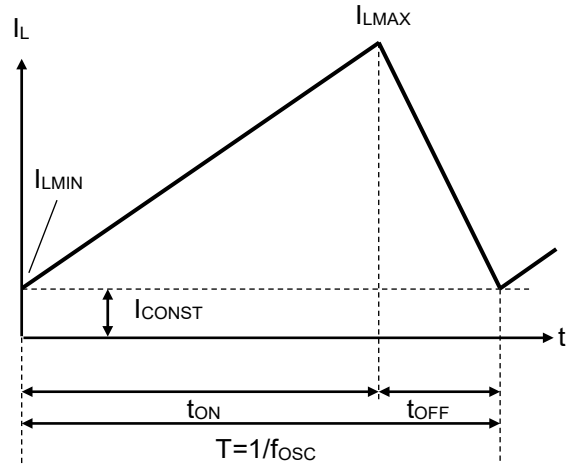

Figure B. Continuous Mode

In the continuous mode, the solution of Equation 1 is described as t_{ONC} .

$$t_{ONC} = T \times V_{OUT} / V_{IN} \dots \dots \dots \text{Equation 2}$$

When $t_{ON} < t_{ONC}$, it is discontinuous mode, and when $t_{ON} = t_{ONC}$, it is continuous mode.

Forced PWM Mode and VFM Mode

Output voltage controlling method is selectable between a forced PWM control type and a PWM/VFM auto-switching control type, and can be set by the MODE pin. The forced PWM control switches at fixed frequency rate in order to reduce noise in low output current. The PWM/VFM auto-switching control automatically switches from PWM mode to VFM mode in order to achieve high efficiency in low output current.

Forced PWM Mode

By setting the MODE pin to “H”, the IC switches the frequency at the fixed rate to reduce noise even when the output load is light. Therefore, when I_{OUT} is $\Delta I_L/2$ or less, I_{LMIN} becomes less than “0”. That is, the accumulated electricity in CL is discharged through the IC side while I_L is increasing from I_{LMIN} to “0” during t_{ON} , and also while I_L is decreasing from “0” to I_{LMIN} during t_{OFF} .

VFM Mode

By setting the MODE pin to “Low”, in low output current, the IC automatically switches into VFM mode in order to achieve high efficiency. In VFM mode, t_{ON} is determined depending on V_{IN} and V_{OUT} .

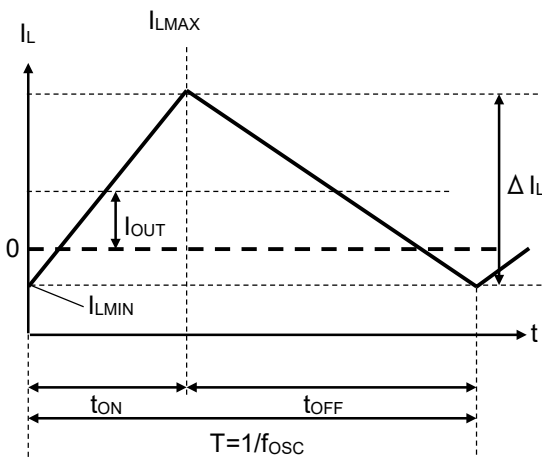

Forced PWM Mode

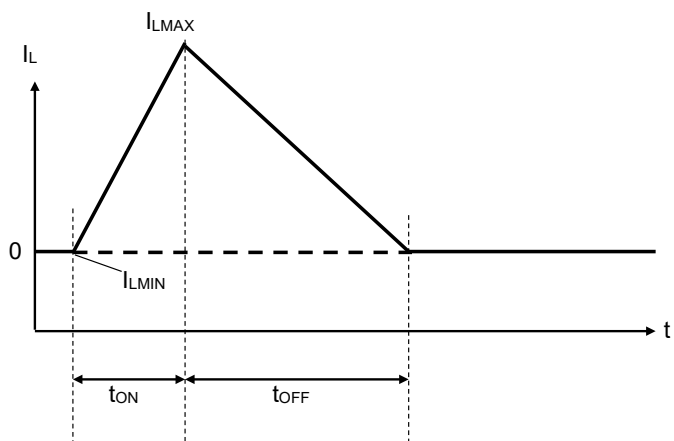

VFM Mode

APPLICATION INFORMATION

Typical Application Circuits

MODE = High: Forced PWM Control, MODE = Low: PWM/VFM Auto-switching Control

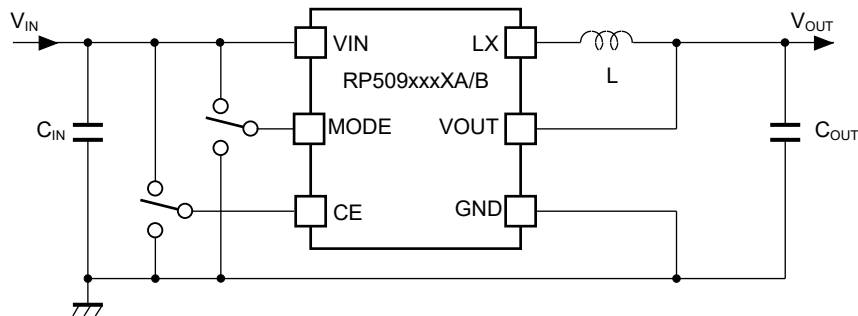

RP509xxxXA/RP509xxxXB (Fixed Output Voltage Type)

MODE = High: Forced PWM Control, MODE = Low: PWM/VFM Auto-switching Control

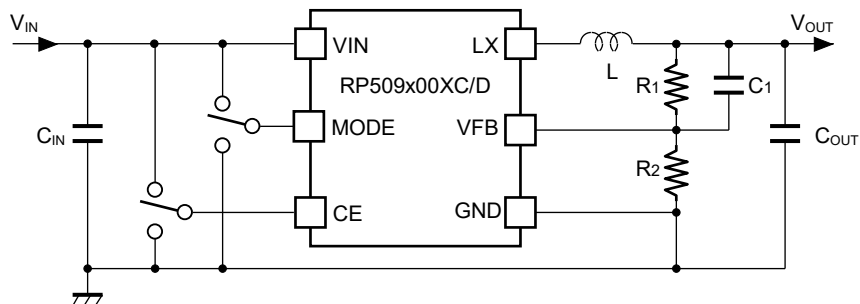

RP509x00XC/RP509x00XD (Adjustable Output Voltage Type)

Recommended External Components

Symbol	Descriptions
C_{IN}	4.7 μ F and more, Ceramic Capacitor, See the table of "Input Voltage vs. Capacitance" in the following page.
C_{OUT}	10 μ F, Ceramic Capacitor, See the table of "Set Output Voltage (V_{SET}) vs. Capacitance" in the following page.
L	0.47 μ H to 0.56 μ H, See the table of "Inductance Range vs. PWM Frequency" in the following page.

Input Voltage vs. Capacitance

V_{IN} [V]	Size [mm]	C_{IN} [μ F]	Rated Voltage [V]	Model
Up to 4.5	1005	4.7	6.3	JMK105BBJ475MV (Taiyo Yuden)
		10	6.3	C1005X5R0J106M050BC (TDK)
	1608	4.7	6.3	GRM188R60J475ME84 (Murata) GRM188R60J475ME19 (Murata) C1608X5R0J475M080AB (TDK) JMK107BJ475MA (Taiyo Yuden)
		10	6.3	GRM188R60J106ME47 (Murata) C1608X5R0J106M080AB (TDK) JMK107ABJ106MA (Taiyo Yuden)
Up to 5.5	1005	10	6.3	C1005X5R0J106M050BC (TDK)
	1608	4.7	6.3	GRM188R60J475ME84 (Murata) GRM188R60J475ME19 (Murata) JMK107BJ475MA (Taiyo Yuden)
		10	6.3	GRM188R60J106ME47 (Murata) C1608X5R0J106M080AB (TDK) JMK107ABJ106MA (Taiyo Yuden)

Set Output Voltage (V_{SET}) vs. Capacitance

Version	V_{SET} [V]	Size [mm]	C_{OUT} [μ F]	Rated Voltage [V]	Model
RP509xxxXA RP509xxxXB or RP509x00XC RP509x00XD	0.6 to 1.8	1005	10	4	GRM155R60G106ME44 (Murata) C1005X5R0G106M050BB (TDK) AMK105CBJ106MV (Taiyo Yuden)
			10	6.3	C1005X5R0J106M050BC (TDK)
	1.9 to 3.3	1608	10	6.3	GRM188R60J106ME47 (Murata) C1608X5R0J106M080AB (TDK) JMK107ABJ106MA (Taiyo Yuden)
			1005	10	4
		10		6.3	C1005X5R0J106M050BC (TDK)
		1608	10	6.3	GRM188R60J106ME47 (Murata) C1608X5R0J106M080AB (TDK) JMK107ABJ106MA (Taiyo Yuden)
RP509x00XC RP509x00XD	3.4 to 4.5	1608	10	6.3	GRM188R60J106ME47 (Murata) C1608X5R0J106M080AB (TDK) JMK107ABJ106MA (Taiyo Yuden)

Inductance Range vs. PWM Frequency

Version	PWM Frequency [MHz]	Size [mm]	Height(Max) [mm]	L [μH]	Rdc (Typ) [mΩ]	Model
RP509xxxXA RP509xxxXB or RP509x00XC RP509x00XD	6.0	1608	0.95	0.47	110	MDT1608-CHR47M (TOKO)
					90	MDT1608-CRR47M (TOKO)
		2012	1.0	0.5	60	MIPSZ2012D0R5 (FDK)
				0.56	65	MDT2012-CRR56N (TOKO)
				0.47	70	MLP2012HR47MT (TDK)
				0.54	65	MLP2012HR54MT (TDK)
				0.47	60	CKP2012NR47M-T (Taiyo Yuden)
				0.47	48	BRL2012TR47M6 (Taiyo Yuden)
	0.47	75	LQM21PNR47MG0 (Murata)			

Precautions for the Selection of External Parts

- Choose a low ESR ceramic capacitor. The capacitance of C_{IN} between V_{IN} and GND should be more than or equal to 4.7 μF. The capacitance of a ceramic capacitor (C_{OUT}) should be 10 μF. Also, choose the capacitor with consideration for bias characteristics and input/output voltages. See the above tables of “Input Voltage vs. Capacitance” and “Set Output Voltage vs. Capacitance”.
- The phase compensation of this device is designed according to the C_{OUT} and L values. The inductance range of an inductor should be between 0.47μH to 0.56 μH in order to gain stability. See the above table of “Inductance Range vs. PWM Frequency”.
- Choose an inductor that has small DC resistance, has enough permissible current and is hard to cause magnetic saturation. If the inductance value of the inductor becomes extremely small under the load conditions, the peak current of LX may increase along with the load current. As a result, over current protection circuit may start to operate when the peak current of LX reaches to LX limit current. Therefore, choose an inductor with consideration for the value of I_{LXMAX}. See the following page of “Calculation Conditions of LX Pin Maximum Output Current (I_{LXMAX})”.
- As for the adjustable output voltage type (RP509x00XC/RP509x00XD), the set output voltage (V_{SET}) can be arbitrarily set by changing the vales of R1 and R2 using the following equation: $V_{SET} = V_{FB} \times (R1 + R2) / R2$

Refer to the following table for the recommended values for R1, R2 and C1.

Set Output Voltage (V_{SET}) vs. R1/R2/C1 (Adjustable Output Voltage Type)

V _{SET} [V]	R1 [kΩ]	R2 [kΩ]	C1 [pF]
0.6	0	220	Open
0.6 < V _{SET} ≤ 0.9	R1 = (V _{SET} / V _{FB} - 1) x R2	220	47
0.9 < V _{SET} ≤ 1.8		220	33
1.8 < V _{SET} ≤ 2.1		150	10
2.1 < V _{SET} ≤ 2.4		100	10
2.4 < V _{SET} ≤ 2.7		68	10
2.7 < V _{SET} ≤ 3.0		47	10
3.0 < V _{SET} ≤ V _{IN}		47	6.8

Calculation Conditions of LX Pin Maximum Output Current (I_{LXMAX})

The following equations explain the relationship to determine I_{LXMAX} at the ideal operation of the ICs in continuous mode.

Ripple Current P-P value is described as I_{RP} , ON resistance of Pch. Tr. is described as R_{ONP} , ON resistance of Nch. Tr. is described as R_{ONN} , and DC resistor of the inductor is described as R_L .

First, when Pch. Tr. is "ON", Equation 1 is satisfied.

$$V_{IN} = V_{OUT} + (R_{ONP} + R_L) \times I_{OUT} + L \times I_{RP} / t_{ON} \dots\dots\dots \text{Equation 1}$$

Second, when Pch. Tr. is "OFF" (Nch. Tr. is "ON"), Equation 2 is satisfied.

$$L \times I_{RP} / t_{OFF} = R_{ONN} \times I_{OUT} + V_{OUT} + R_L \times I_{OUT} \dots\dots\dots \text{Equation 2}$$

Put Equation 2 into Equation 1 to solve ON duty of Pch. Tr. ($D_{ON} = t_{ON} / (t_{OFF} + t_{ON})$):

$$D_{ON} = (V_{OUT} + R_{ONN} \times I_{OUT} + R_L \times I_{OUT}) / (V_{IN} + R_{ONN} \times I_{OUT} - R_{ONP} \times I_{OUT}) \dots\dots\dots \text{Equation 3}$$

Ripple Current is described as follows:

$$I_{RP} = (V_{IN} - V_{OUT} - R_{ONP} \times I_{OUT} - R_L \times I_{OUT}) \times D_{ON} / f_{OSC} / L \dots\dots\dots \text{Equation 4}$$

Peak current that flows through L, and LX Tr. is described as follows:

$$I_{LXMAX} = I_{OUT} + I_{RP} / 2 \dots\dots\dots \text{Equation 5}$$

TECHNICAL NOTES

The performance of a power source circuit using this device is highly dependent on a peripheral circuit. A peripheral component or the device mounted on PCB should not exceed its rated voltage, rated current or rated power. When designing a peripheral circuit, please be fully aware of the following points.

- Set the external components as close as possible to the IC and minimize the wiring between the components and the IC. Especially, place a capacitor (C_{IN}) as close as possible to the VIN pin and GND.
- Ensure the VIN and GND lines are sufficiently robust. If their impedance is too high, noise pickup or unstable operation may result.
- The VIN line, the GND line, the VOUT line, an inductor, and LX should make special considerations for the large switching current flows.
- The wiring between the VOUT pin and an inductor (L) (RP509xxxXA/RP509xxxXB) or between a resistor for setting output voltage (R1) and L (RP509x00XC/RP509x00XD) should be separated from the wiring between L and Load.
- Over current protection circuit may be affected by self-heating or power dissipation environment.
- For any setting type of output voltage, the input/output voltage ratio must meet the following requirement to achieve a stable VFM mode at light load when the MODE pin is “Low” (at PWM/VFM Auto Switching):

$$V_{OUT} / V_{IN} < 0.7$$

$V_{MODE} = \text{Low, PWM/VFM Auto Switching}$

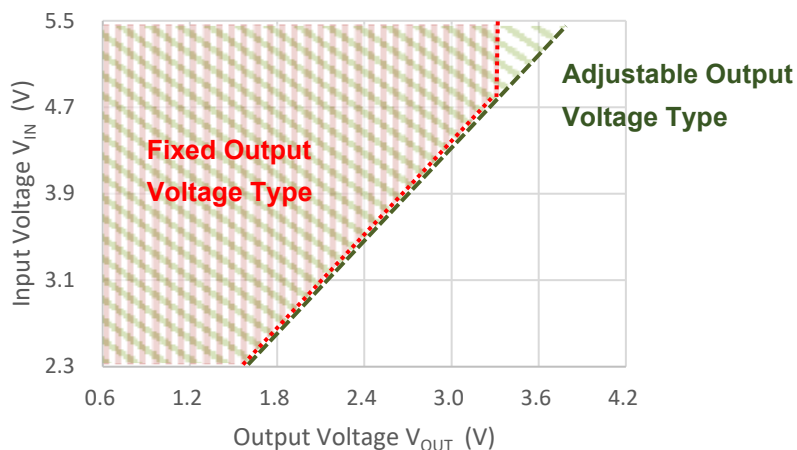

Available Voltage Area with Stable VFM Mode

PCB LAYOUT

Fixed Output Voltage Type (RP509ZxxXA/B)

Top Layer

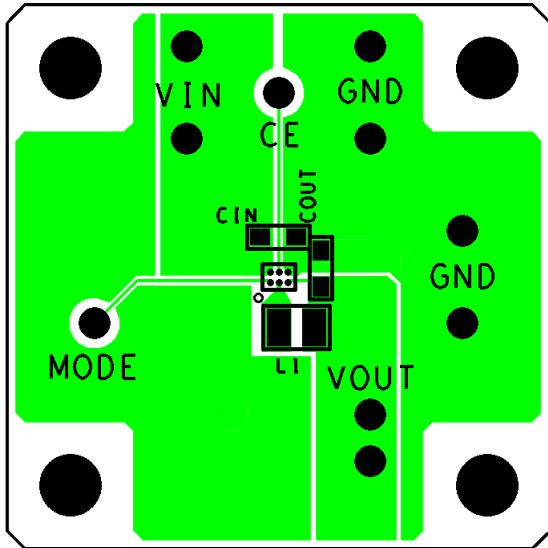

Bottom Layer

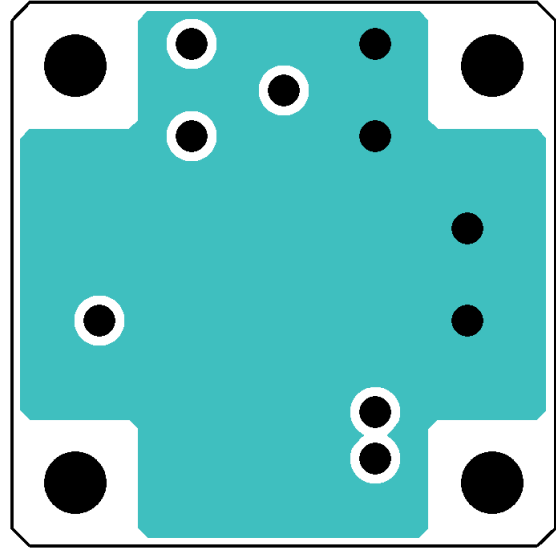

Adjustable Output Voltage Type (RP509Z00XC/D)

Top Layer

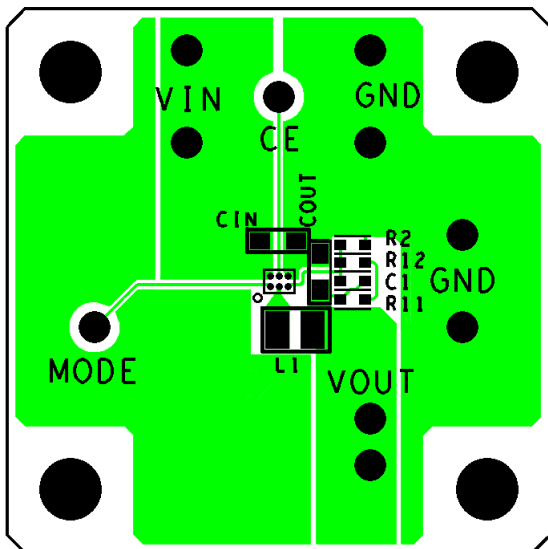

Bottom Layer

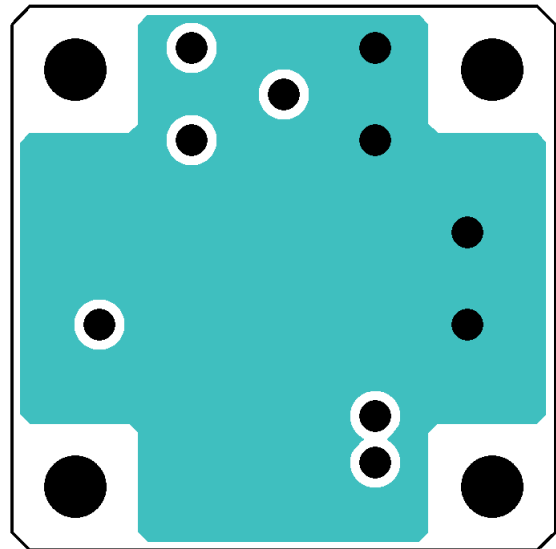

Adjustable Output Voltage Type (RP509N00XC/D)

Top Layer

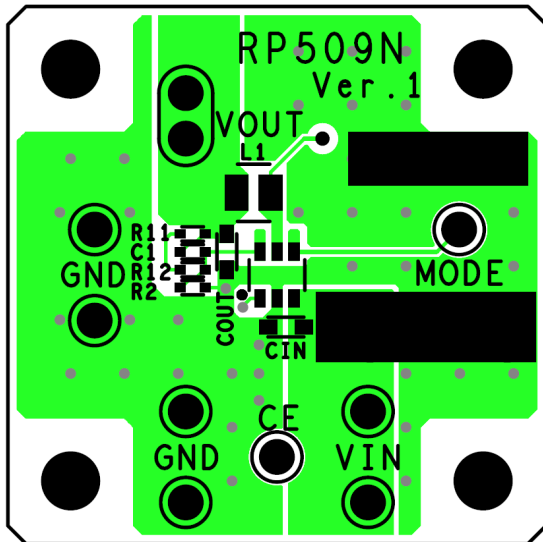

Bottom Layer

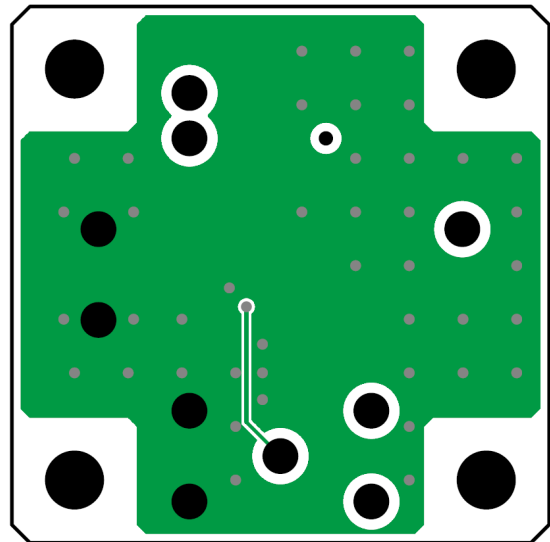

TYPICAL CHARACTERISTICS

Note: Typical Characteristics are intended to be used as reference data; they are not guaranteed.

1) Efficiency vs. Output Current (RP509Z)

$V_{OUT} = 1.0\text{ V}$

$V_{MODE} = \text{"L" PWM/VFM Auto Switching}$

$L = \text{MIPSZ2012D0R5}$

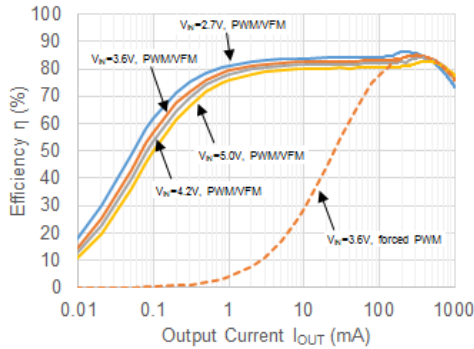

$V_{OUT} = 1.2\text{ V}$

$V_{MODE} = \text{"L" PWM/VFM Auto Switching}$

$L = \text{MIPSZ2012D0R5}$

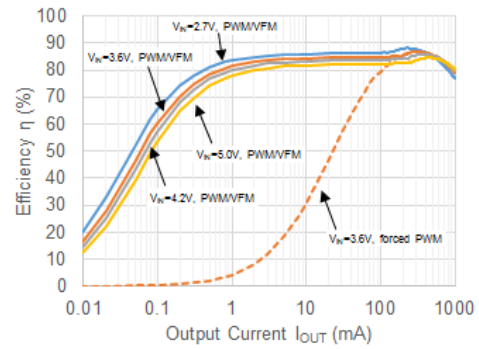

$V_{OUT} = 1.8\text{ V}$

$V_{MODE} = \text{"L" PWM/VFM Auto Switching}$

$L = \text{MIPSZ2012D0R5}$

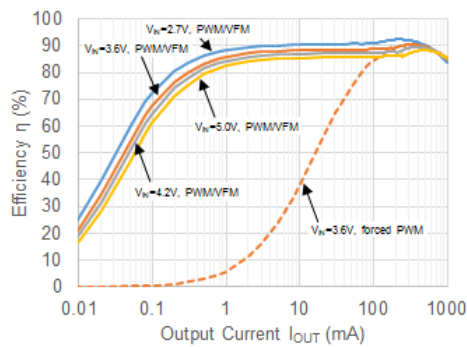

$V_{OUT} = 3.3\text{ V (Fixed Output Voltage Type)}$

$V_{MODE} = \text{"L" PWM/VFM Auto Switching}$

$L = \text{MIPSZ2012D0R5}$

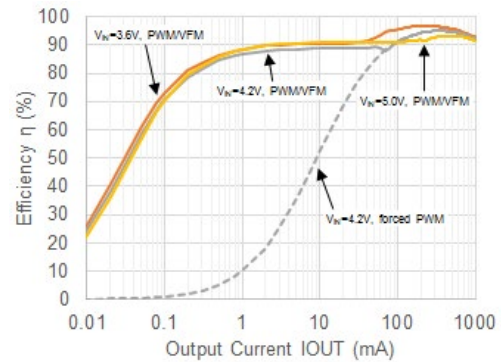

$V_{OUT} = 1.8\text{ V}$

$V_{MODE} = \text{"H" Forced PWM Mode}$

$L = \text{MIPSZ2012D0R5}$

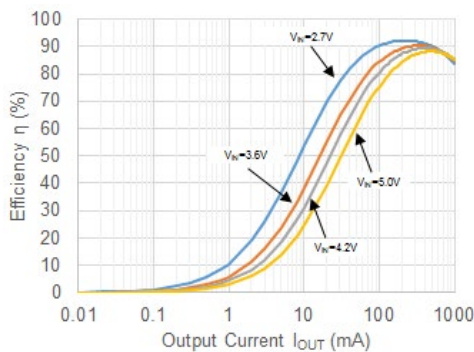

Efficiency vs. Output Current (RP509N)

$V_{OUT} = 1.0\text{ V}$

$V_{MODE} = \text{"L" PWM/VFM Auto Switching}$

$L = \text{MIPSSZ2012D0R5}$

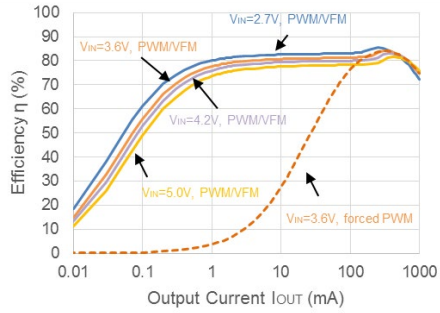

$V_{OUT} = 1.2\text{ V}$

$V_{MODE} = \text{"L" PWM/VFM Auto Switching}$

$L = \text{MIPSSZ2012D0R5}$

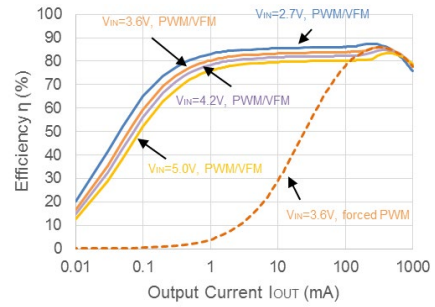

$V_{OUT} = 1.8\text{ V}$

$V_{MODE} = \text{"L" PWM/VFM Auto Switching}$

$L = \text{MIPSSZ2012D0R5}$

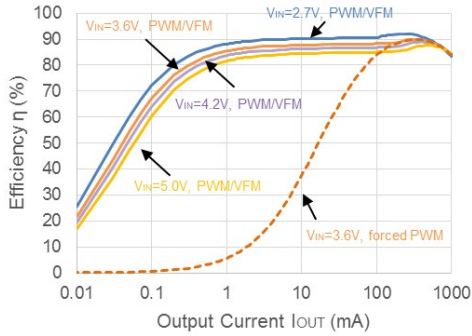

$V_{OUT} = 3.3\text{ V (Fixed Output Voltage Type)}$

$V_{MODE} = \text{"L" PWM/VFM Auto Switching}$

$L = \text{MIPSSZ2012D0R5}$

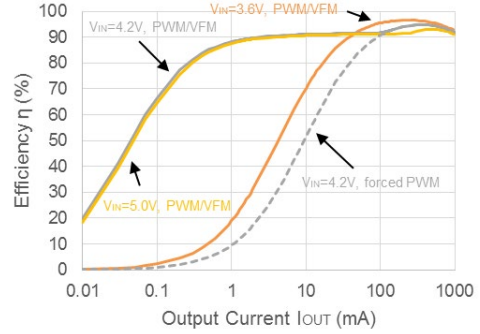

$V_{OUT} = 1.8\text{ V}$

$V_{MODE} = \text{"H" Forced PWM Mode}$

$L = \text{MIPSSZ2012D0R5}$

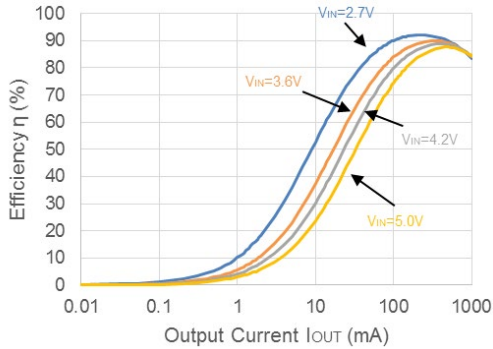

Small Mount Solution (RP509Z)

$V_{OUT} = 1.0\text{ V}$

$V_{MODE} = \text{"L" PWM/VFM Auto Switching}$

$L = \text{MDT1608-CRR47M}$

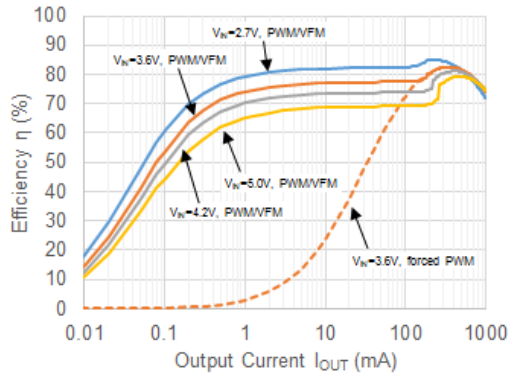

$V_{OUT} = 1.2\text{ V}$

$V_{MODE} = \text{"L" PWM/VFM Auto Switching}$

$L = \text{MDT1608-CRR47M}$

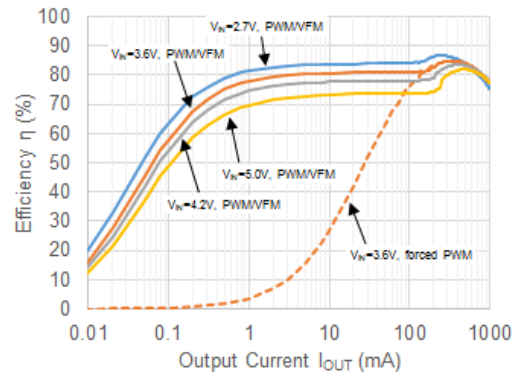

$V_{OUT} = 1.8\text{ V}$

$V_{MODE} = \text{"L" PWM/VFM Auto Switching}$

$L = \text{MDT1608-CRR47M}$

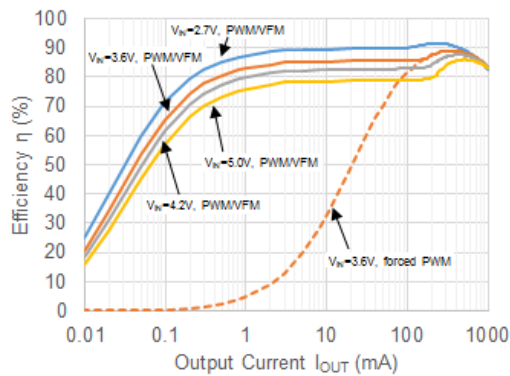

$V_{OUT} = 3.3\text{ V (Fixed Output Voltage Type)}$

$V_{MODE} = \text{"L" PWM/VFM Auto Switching}$

$L = \text{MDT1608-CRR47M}$

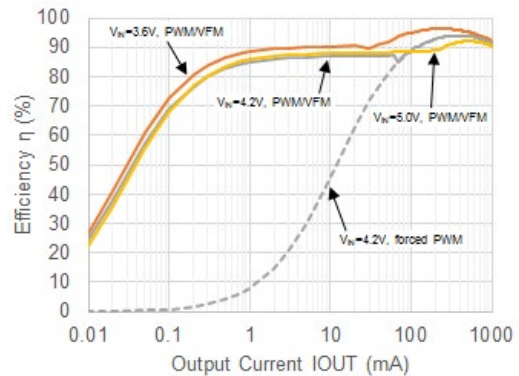

$V_{OUT} = 1.8\text{ V}$

$V_{MODE} = \text{"H" Forced PWM Mode}$

$L = \text{MDT1608-CRR47M}$

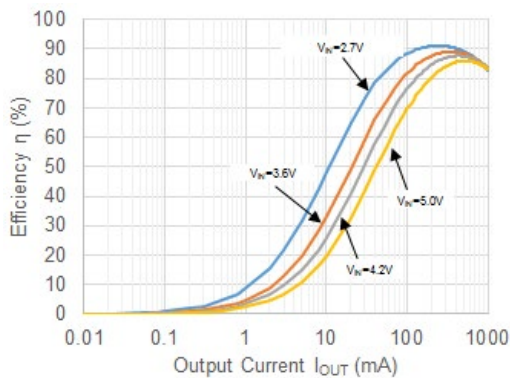

2) Output Voltage vs. Output Current (RP509Z)

$V_{IN} = 3.6\text{ V}$, $V_{OUT} = 1.8\text{ V}$

$V_{MODE} = \text{"L"}$ PWM/VFM Auto Switching

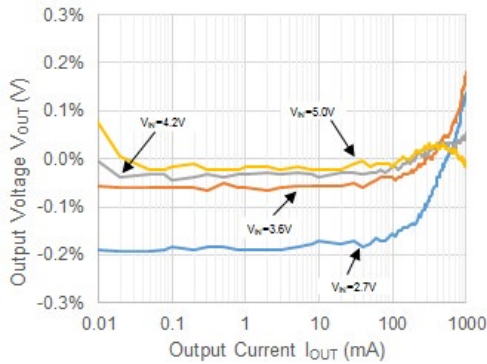

$V_{IN} = 3.6\text{ V}$, $V_{OUT} = 1.8\text{ V}$

$V_{MODE} = \text{"H"}$ Forced PWM Mode

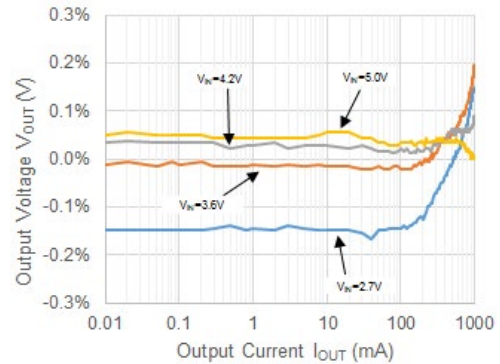

Output Voltage vs. Output Current (RP509N)

$V_{IN} = 3.6\text{ V}$, $V_{OUT} = 1.8\text{ V}$

$V_{MODE} = \text{"L"}$ PWM/VFM Auto Switching

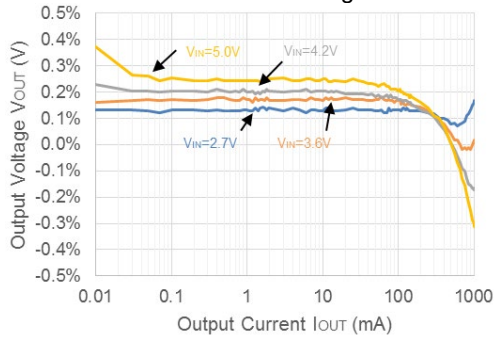

$V_{IN} = 3.6\text{ V}$, $V_{OUT} = 1.8\text{ V}$

$V_{MODE} = \text{"H"}$ Forced PWM Mode

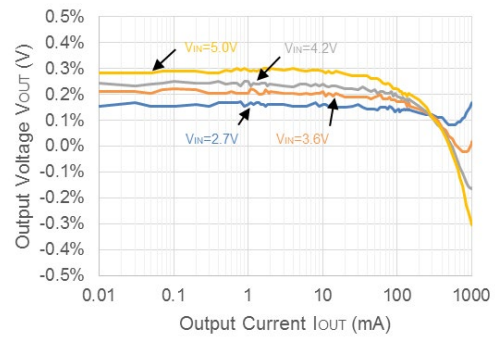

3) Oscillator Frequency vs. Input Voltage

$I_{OUT} = 1.0\text{ mA}$

$V_{MODE} = \text{"L"}$ PWM/VFM Auto Switching

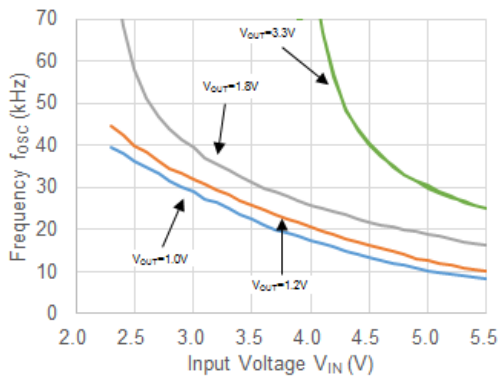

$I_{OUT} = 1.0\text{ mA}$

$V_{MODE} = \text{"H"}$ Forced PWM Mode

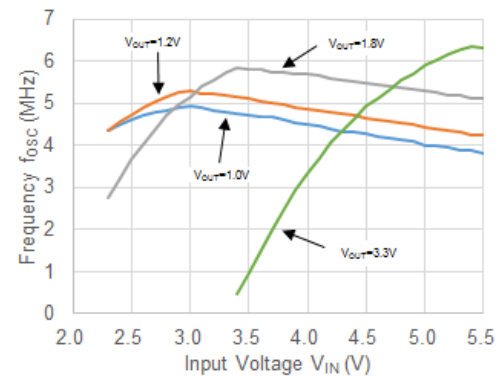

$I_{OUT} = 500 \text{ mA}$
 $V_{MODE} = \text{"H"}$ Forced PWM Mode

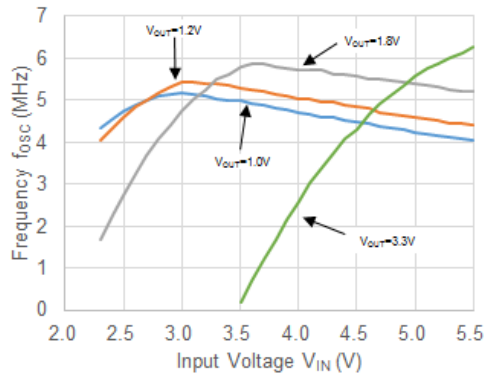

4) Load Transient Response Waveform

$V_{IN} = 3.6 \text{ V}$, $V_{OUT} = 1.8 \text{ V}$
 $V_{MODE} = \text{"L"}$ PWM/VFM Auto Switching
 $I_{OUT} = 1.0 \rightarrow 500 \text{ mA}$

$V_{IN} = 3.6 \text{ V}$, $V_{OUT} = 1.8 \text{ V}$
 $V_{MODE} = \text{"L"}$ PWM/VFM Auto Switching
 $I_{OUT} = 500 \rightarrow 1.0 \text{ mA}$

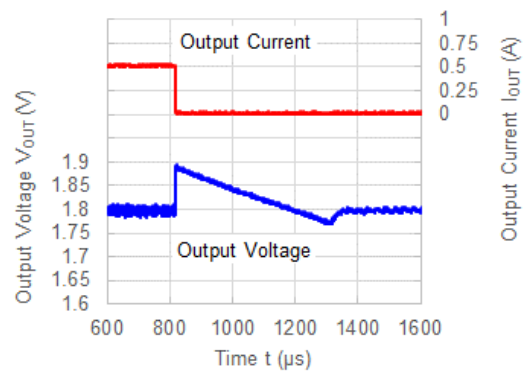
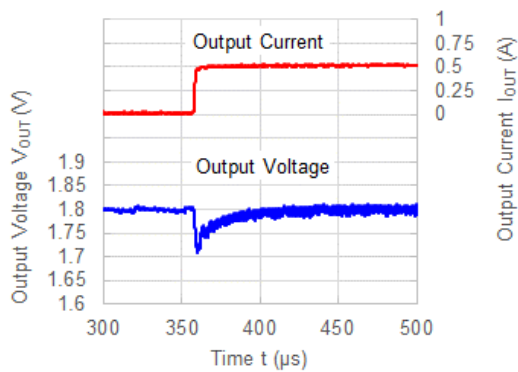

$V_{IN} = 3.6 \text{ V}$, $V_{OUT} = 1.8 \text{ V}$
 $V_{MODE} = \text{"H"}$ Forced PWM Mode
 $I_{OUT} = 1.0 \rightarrow 500 \text{ mA}$

$V_{IN} = 3.6 \text{ V}$, $V_{OUT} = 1.8 \text{ V}$
 $V_{MODE} = \text{"H"}$ Forced PWM Mode
 $I_{OUT} = 500 \rightarrow 1.0 \text{ mA}$

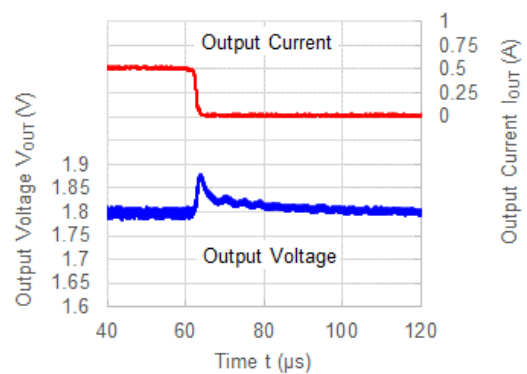
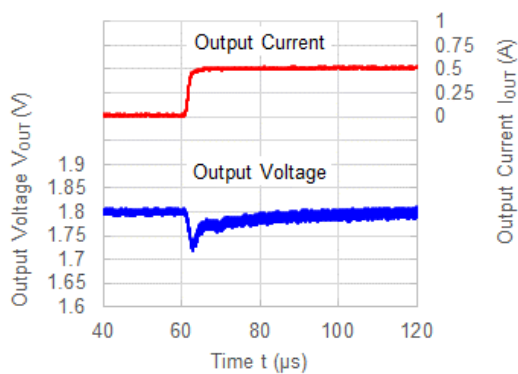

$V_{IN} = 3.6\text{ V}$, $V_{OUT} = 1.8\text{ V}$
 $V_{MODE} = \text{"L"}$ PWM/VFM Auto Switching
 $I_{OUT} = 300 \rightarrow 600\text{ mA}$

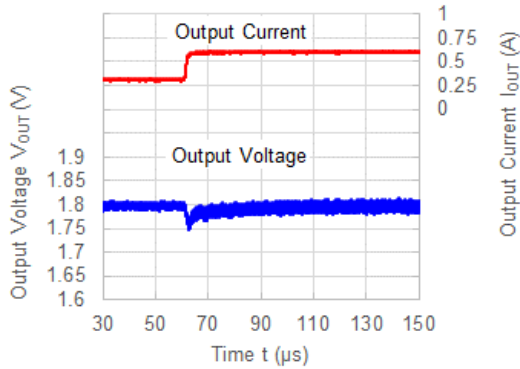

$V_{IN} = 3.6\text{ V}$, $V_{OUT} = 1.8\text{ V}$
 $V_{MODE} = \text{"L"}$ PWM/VFM Auto Switching
 $I_{OUT} = 600 \rightarrow 300\text{ mA}$

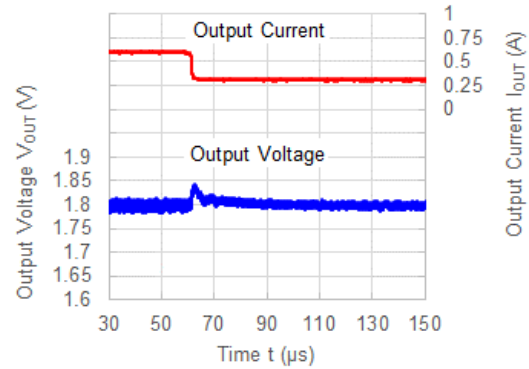

$V_{IN} = 3.6\text{ V}$, $V_{OUT} = 1.8\text{ V}$
 $V_{MODE} = \text{"H"}$ Forced PWM Mode
 $I_{OUT} = 300 \rightarrow 600\text{ mA}$

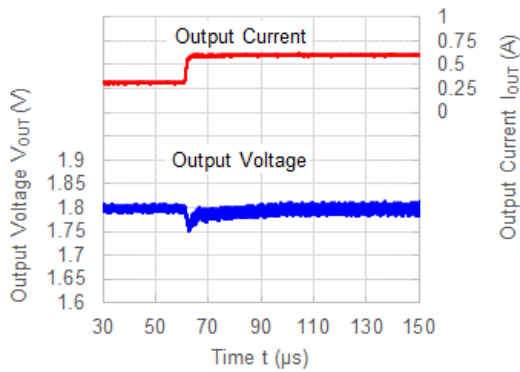

$V_{IN} = 3.6\text{ V}$, $V_{OUT} = 1.8\text{ V}$
 $V_{MODE} = \text{"H"}$ Forced PWM Mode
 $I_{OUT} = 600 \rightarrow 300\text{ mA}$

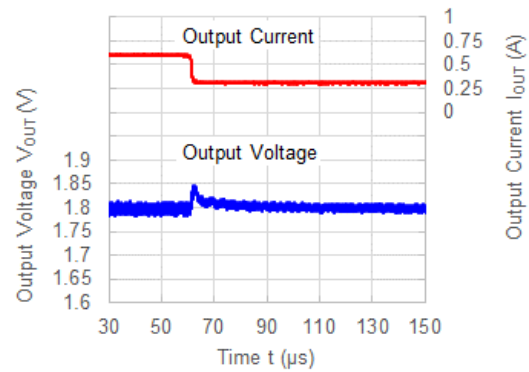

5) Mode Switching Waveform

$V_{IN} = 3.6\text{ V}$, $V_{OUT} = 1.8\text{ V}$
 $I_{OUT} = 1.0\text{ mA}$
 $V_{MODE} = \text{"L"} \rightarrow \text{"H"}$

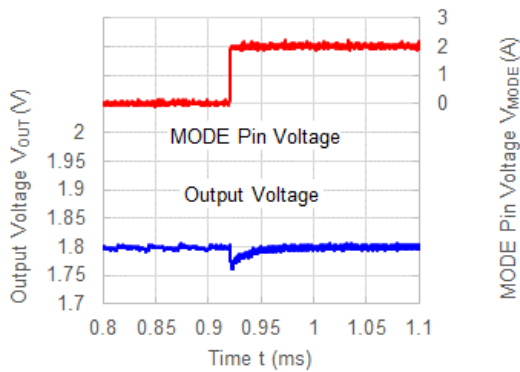

$V_{IN} = 3.6\text{ V}$, $V_{OUT} = 1.8\text{ V}$
 $I_{OUT} = 1.0\text{ mA}$
 $V_{MODE} = \text{"H"} \rightarrow \text{"L"}$

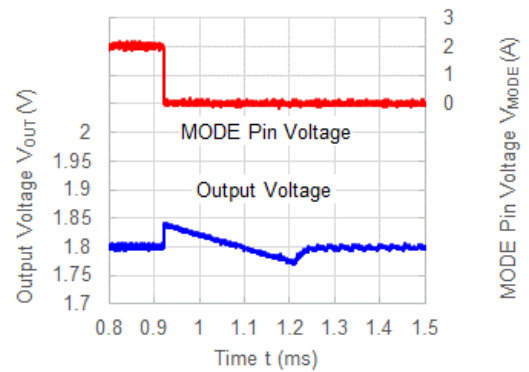

6) Output Voltage Waveform

$V_{IN} = 3.6\text{ V}$, $V_{OUT} = 1.8\text{ V}$

$V_{MODE} = \text{"L"}$ PWM/VFM Auto Switching

$I_{OUT} = 1.0\text{ mA}$

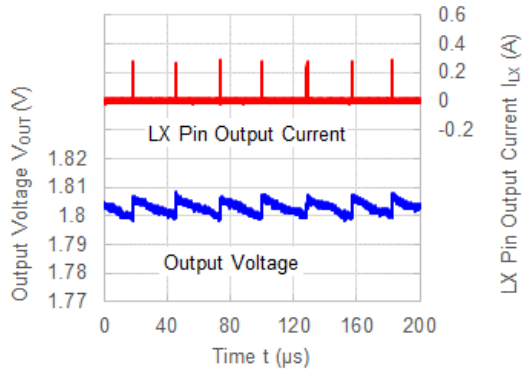

$V_{IN} = 3.6\text{ V}$, $V_{OUT} = 1.8\text{ V}$

$V_{MODE} = \text{"H"}$ Forced PWM Mode

$I_{OUT} = 1.0\text{ mA}$

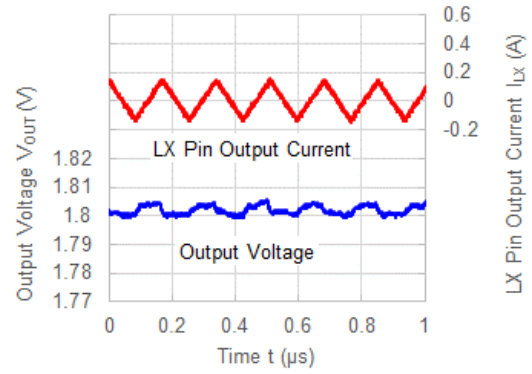

$V_{IN} = 3.6\text{ V}$, $V_{OUT} = 1.8\text{ V}$

$V_{MODE} = \text{"L"}$ PWM/VFM Auto Switching

$I_{OUT} = 500\text{ mA}$

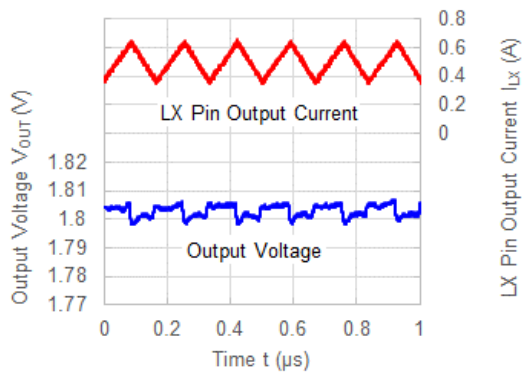

$V_{IN} = 3.6\text{ V}$, $V_{OUT} = 1.8\text{ V}$

$V_{MODE} = \text{"H"}$ Forced PWM Mode

$I_{OUT} = 500\text{ mA}$

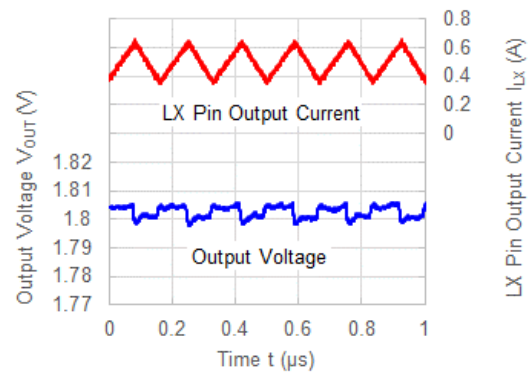

The power dissipation of the package is dependent on PCB material, layout, and environmental conditions. The following measurement conditions are based on JEDEC STD. 51-9.

Measurement Conditions

Item	Measurement Conditions
Environment	Mounting on Board (Wind Velocity = 0 m/s)
Board Material	Glass Cloth Epoxy Plastic (Four-Layer Board)
Board Dimensions	101.5 mm x 114.5 mm x 1.6 mm
Copper Ratio	Outer Layers (First and Fourth Layers): 60% Inner Layers (Second and Third Layers): 100%

Measurement Result

(Ta = 25°C, Tjmax = 125°C)

Item	Measurement Result
Power Dissipation	910 mW
Thermal Resistance (θ_{ja})	$\theta_{ja} = 109^\circ\text{C/W}$

θ_{ja} : Junction-to-Ambient Thermal Resistance

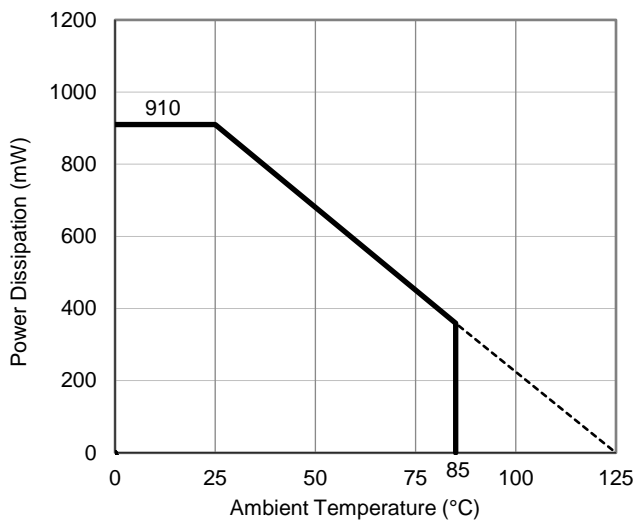

Power Dissipation vs. Ambient Temperature

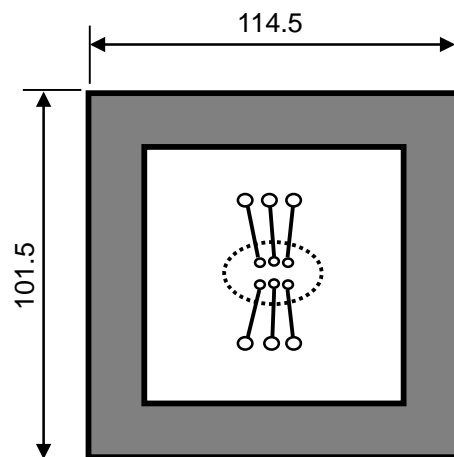

Measurement Board Pattern

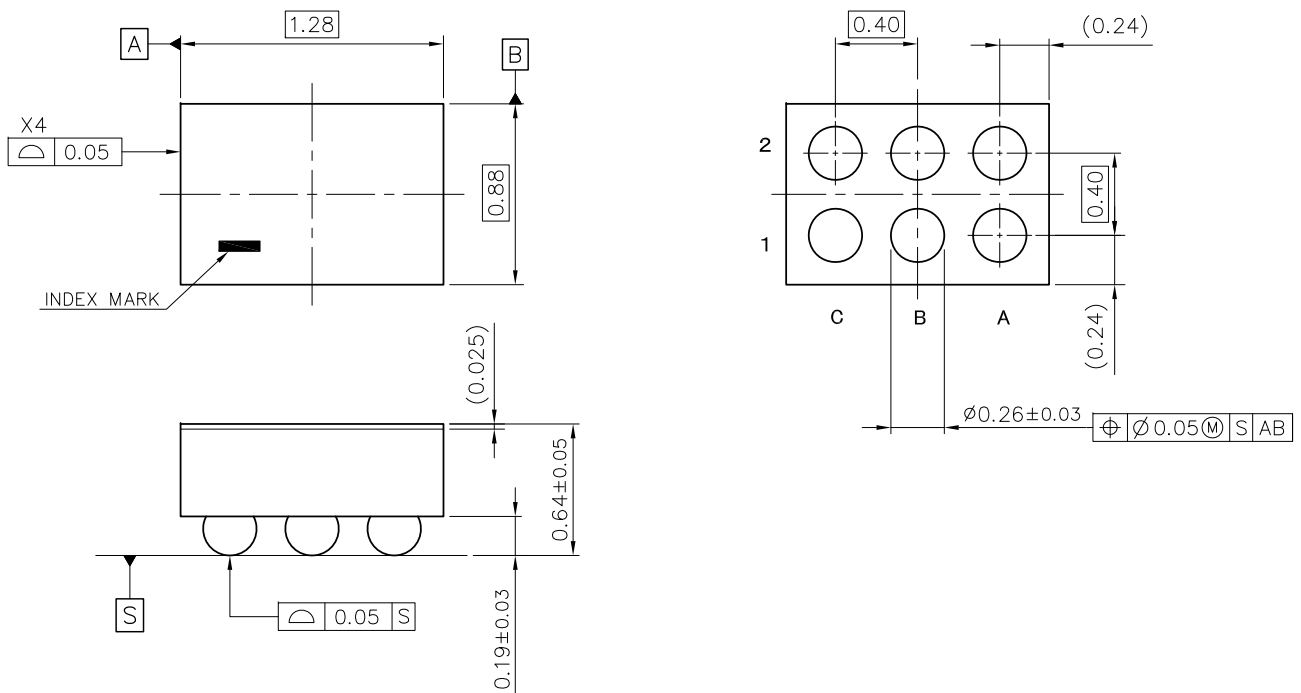

WLCSP-6-P6 Package Dimensions (Unit: mm)

- ①: Product Code ... Refer to *Part Marking List*
- ②③: Lot Number ... Alphanumeric Serial Number

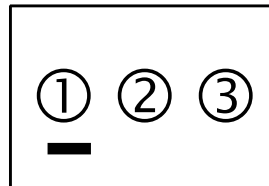

WLCSP-6-P6 Part Markings

NOTICE

There can be variation in the marking when different AOI (Automated Optical Inspection) equipment is used. In the case of recognizing the marking characteristic with AOI, please contact our sales or our distributor before attempting to use AOI.

RP509Zxx1A/RP509Zxx2A (Fixed Output Voltage Type) Part Marking List

Product Name	①	②③	Product Name	①	②③	V _{SET}
RP509Z061A	1	Lot No.	RP509Z062A	1	Lot No.	0.6 V
RP509Z071A	1	Lot No.	RP509Z072A	1	Lot No.	0.7 V
RP509Z081A	1	Lot No.	RP509Z082A	1	Lot No.	0.8 V
RP509Z091A	1	Lot No.	RP509Z092A	1	Lot No.	0.9 V
RP509Z101A	1	Lot No.	RP509Z102A	1	Lot No.	1.0 V
RP509Z111A	1	Lot No.	RP509Z112A	1	Lot No.	1.1 V
RP509Z121A	1	Lot No.	RP509Z122A	1	Lot No.	1.2 V
RP509Z131A	1	Lot No.	RP509Z132A	1	Lot No.	1.3 V
RP509Z141A	1	Lot No.	RP509Z142A	1	Lot No.	1.4 V
RP509Z151A	1	Lot No.	RP509Z152A	1	Lot No.	1.5 V
RP509Z161A	1	Lot No.	RP509Z162A	1	Lot No.	1.6 V
RP509Z171A	1	Lot No.	RP509Z172A	1	Lot No.	1.7 V
RP509Z181A	1	Lot No.	RP509Z182A	1	Lot No.	1.8 V
RP509Z191A	1	Lot No.	RP509Z192A	1	Lot No.	1.9 V
RP509Z201A	1	Lot No.	RP509Z202A	1	Lot No.	2.0 V
RP509Z211A	1	Lot No.	RP509Z212A	1	Lot No.	2.1 V
RP509Z221A	1	Lot No.	RP509Z222A	1	Lot No.	2.2 V
RP509Z231A	1	Lot No.	RP509Z232A	1	Lot No.	2.3 V
RP509Z241A	1	Lot No.	RP509Z242A	1	Lot No.	2.4 V
RP509Z251A	1	Lot No.	RP509Z252A	1	Lot No.	2.5 V
RP509Z261A	1	Lot No.	RP509Z262A	1	Lot No.	2.6 V
RP509Z271A	1	Lot No.	RP509Z272A	1	Lot No.	2.7 V
RP509Z281A	1	Lot No.	RP509Z282A	1	Lot No.	2.8 V
RP509Z291A	1	Lot No.	RP509Z292A	1	Lot No.	2.9 V
RP509Z301A	1	Lot No.	RP509Z302A	1	Lot No.	3.0 V
RP509Z311A	1	Lot No.	RP509Z312A	1	Lot No.	3.1 V
RP509Z321A	1	Lot No.	RP509Z322A	1	Lot No.	3.2 V
RP509Z331A	1	Lot No.	RP509Z332A	1	Lot No.	3.3 V

RP509Zxx1B/RP509Zxx2B (Fixed Output Voltage Type) Part Marking List

Product Name	①	②③	Product Name	①	②③	V _{SET}
RP509Z061B	1	Lot No.	RP509Z062B	1	Lot No.	0.6 V
RP509Z061B5	1	Lot No.	RP509Z062B5	1	Lot No.	0.65V
RP509Z071B	1	Lot No.	RP509Z072B	1	Lot No.	0.7 V
RP509Z081B	1	Lot No.	RP509Z082B	1	Lot No.	0.8 V
RP509Z091B	1	Lot No.	RP509Z092B	1	Lot No.	0.9 V
RP509Z101B	1	Lot No.	RP509Z102B	1	Lot No.	1.0 V
RP509Z111B	1	Lot No.	RP509Z112B	1	Lot No.	1.1 V
RP509Z121B	1	Lot No.	RP509Z122B	1	Lot No.	1.2 V
RP509Z131B	1	Lot No.	RP509Z132B	1	Lot No.	1.3 V
RP509Z141B	1	Lot No.	RP509Z142B	1	Lot No.	1.4 V
RP509Z151B	1	Lot No.	RP509Z152B	1	Lot No.	1.5 V
RP509Z161B	1	Lot No.	RP509Z162B	1	Lot No.	1.6 V
RP509Z171B	1	Lot No.	RP509Z172B	1	Lot No.	1.7 V
RP509Z181B	1	Lot No.	RP509Z182B	1	Lot No.	1.8 V
RP509Z191B	1	Lot No.	RP509Z192B	1	Lot No.	1.9 V
RP509Z201B	1	Lot No.	RP509Z202B	1	Lot No.	2.0 V
RP509Z211B	1	Lot No.	RP509Z212B	1	Lot No.	2.1 V
RP509Z221B	1	Lot No.	RP509Z222B	1	Lot No.	2.2 V
RP509Z231B	1	Lot No.	RP509Z232B	1	Lot No.	2.3 V
RP509Z241B	1	Lot No.	RP509Z242B	1	Lot No.	2.4 V
RP509Z251B	1	Lot No.	RP509Z252B	1	Lot No.	2.5 V
RP509Z261B	1	Lot No.	RP509Z262B	1	Lot No.	2.6 V
RP509Z271B	1	Lot No.	RP509Z272B	1	Lot No.	2.7 V
RP509Z281B	1	Lot No.	RP509Z282B	1	Lot No.	2.8 V
RP509Z291B	1	Lot No.	RP509Z292B	1	Lot No.	2.9 V
RP509Z301B	1	Lot No.	RP509Z302B	1	Lot No.	3.0 V
RP509Z311B	1	Lot No.	RP509Z312B	1	Lot No.	3.1 V
RP509Z321B	1	Lot No.	RP509Z322B	1	Lot No.	3.2 V
RP509Z331B	1	Lot No.	RP509Z332B	1	Lot No.	3.3 V
RP509Z101B5	1	Lot No.	-	-	-	1.05 V
-	-	-	RP509Z112B5	1	Lot No.	1.15 V
RP509Z131B5	1	Lot No.	RP509Z132B5	1	Lot No.	1.35 V

RP509Z00XC/RP509Z00XD (Adjustable Output Voltage Type) Part Marking List

Product Name	①	②③	Product Name	①	②③	V_{SET}
RP509Z001C	1	Lot No.	RP509Z002C	1	Lot No.	-
RP509Z001D	1	Lot No.	RP509Z002D	1	Lot No.	-

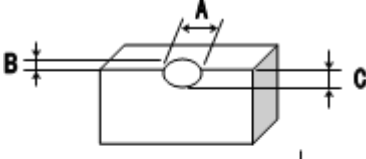
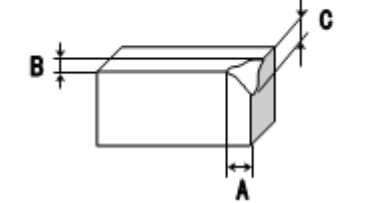
No.	Inspection Items	Inspection Criteria	Figure
1	Package chipping	<p>$A \geq 0.2\text{mm}$ is rejected $B \geq 0.2\text{mm}$ is rejected $C \geq 0.2\text{mm}$ is rejected And, Package chipping to Si surface and to bump is rejected.</p>	
2	Si surface chipping	<p>$A \geq 0.2\text{mm}$ is rejected $B \geq 0.2\text{mm}$ is rejected $C \geq 0.2\text{mm}$ is rejected But, even if $A \geq 0.2\text{mm}$, $B \leq 0.1\text{mm}$ is acceptable.</p>	
3	No bump	No bump is rejected.	
4	Marking miss	To reject incorrect marking, such as another product name marking or another lot No. marking.	
5	No marking	To reject no marking on the package.	
6	Reverse direction of marking	To reject reverse direction of marking character.	
7	Defective marking	To reject unreadable marking. (Microscope: X15/ White LED/ Viewed from vertical direction)	
8	Scratch	To reject unreadable marking character by scratch. (Microscope: X15/ White LED/ Viewed from vertical direction)	
9	Stain and Foreign material	To reject unreadable marking character by stain and foreign material. (Microscope: X15/ White LED/ Viewed from vertical direction)	

The power dissipation of the package is dependent on PCB material, layout, and environmental conditions. The following measurement conditions are based on JEDEC STD. 51-7.

Measurement Conditions

Item	Measurement Conditions
Environment	Mounting on Board (Wind Velocity = 0 m/s)
Board Material	Glass Cloth Epoxy Plastic (Four-Layer Board)
Board Dimensions	76.2 mm × 114.3 mm × 0.8 mm
Copper Ratio	Outer Layer (First Layer): Less than 95% of 50 mm Square Inner Layers (Second and Third Layers): Approx. 100% of 50 mm Square Outer Layer (Fourth Layer): Approx. 100% of 50 mm Square
Through-holes	φ 0.3 mm × 7 pcs

Measurement Result

(Ta = 25°C, Tjmax = 125°C)

Item	Measurement Result
Power Dissipation	892 mW
Thermal Resistance (θ_{ja})	$\theta_{ja} = 112^{\circ}\text{C/W}$
Thermal Characterization Parameter (ψ_{jt})	$\psi_{jt} = 51^{\circ}\text{C/W}$

θ_{ja} : Junction-to-Ambient Thermal Resistance

ψ_{jt} : Junction-to-Top Thermal Characterization Parameter

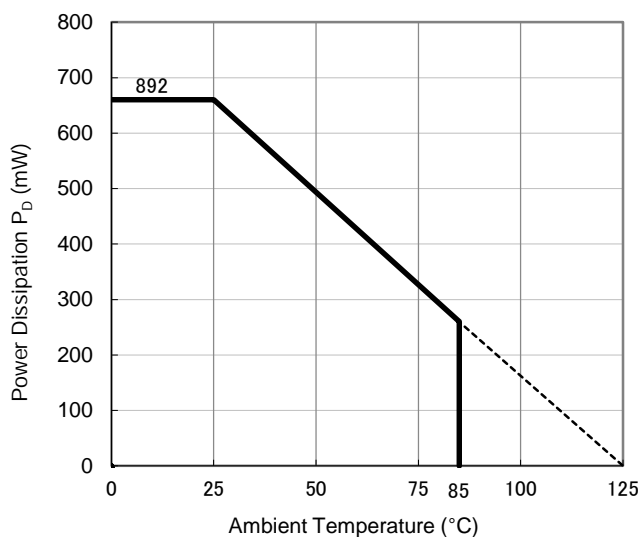

Power Dissipation vs. Ambient Temperature

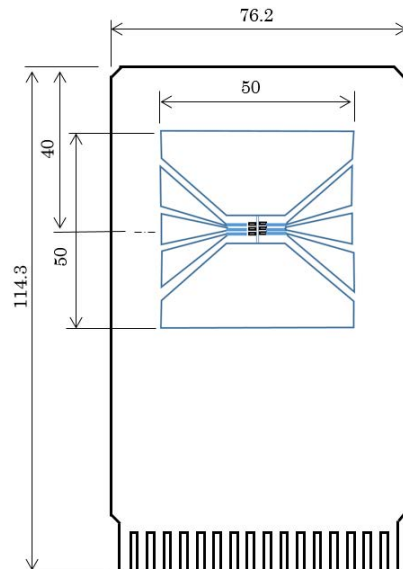

Measurement Board Pattern

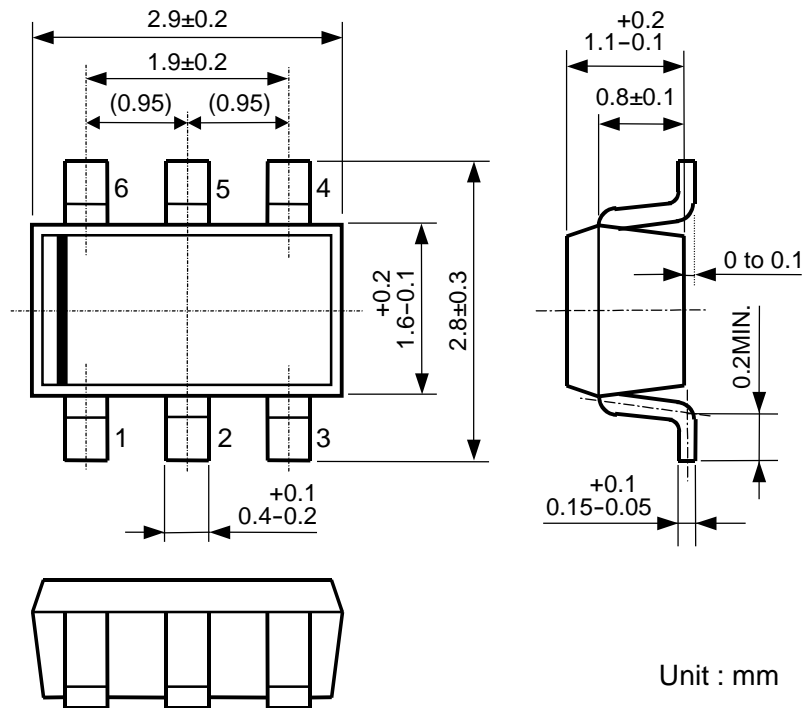

SOT-23-6 Package Dimensions (Unit: mm)

①②③: Product Code ... Refer to *Part Marking List*

④⑤: Lot Number ... Alphanumeric Serial Number

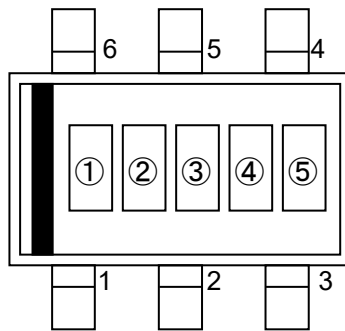

SOT-23-6 Part Markings

NOTICE

There can be variation in the marking when different AOI (Automated Optical Inspection) equipment is used. In the case of recognizing the marking characteristic with AOI, please contact our sales or our distributor before attempting to use AOI.

RP509Nxx1A/RP509Nxx2A (Fixed Output Voltage Type) Part Marking List

Product Name	①②③	④⑤	Product Name	①②③	④⑤	V _{SET}
RP509N061A	C06	Lot No.	RP509N062A	D06	Lot No.	0.6 V
RP509N071A	C07	Lot No.	RP509N072A	D07	Lot No.	0.7 V
RP509N081A	C08	Lot No.	RP509N082A	D08	Lot No.	0.8 V
RP509N091A	C09	Lot No.	RP509N092A	D09	Lot No.	0.9 V
RP509N101A	C10	Lot No.	RP509N102A	D10	Lot No.	1.0 V
RP509N111A	C11	Lot No.	RP509N112A	D11	Lot No.	1.1 V
RP509N121A	C12	Lot No.	RP509N122A	D12	Lot No.	1.2 V
RP509N131A	C13	Lot No.	RP509N132A	D13	Lot No.	1.3 V
RP509N141A	C14	Lot No.	RP509N142A	D14	Lot No.	1.4 V
RP509N151A	C15	Lot No.	RP509N152A	D15	Lot No.	1.5 V
RP509N161A	C16	Lot No.	RP509N162A	D16	Lot No.	1.6 V
RP509N171A	C17	Lot No.	RP509N172A	D17	Lot No.	1.7 V
RP509N181A	C18	Lot No.	RP509N182A	D18	Lot No.	1.8 V
RP509N191A	C19	Lot No.	RP509N192A	D19	Lot No.	1.9 V
RP509N201A	C20	Lot No.	RP509N202A	D20	Lot No.	2.0 V
RP509N211A	C21	Lot No.	RP509N212A	D21	Lot No.	2.1 V
RP509N221A	C22	Lot No.	RP509N222A	D22	Lot No.	2.2 V
RP509N231A	C23	Lot No.	RP509N232A	D23	Lot No.	2.3 V
RP509N241A	C24	Lot No.	RP509N242A	D24	Lot No.	2.4 V
RP509N251A	C25	Lot No.	RP509N252A	D25	Lot No.	2.5 V
RP509N261A	C26	Lot No.	RP509N262A	D26	Lot No.	2.6 V
RP509N271A	C27	Lot No.	RP509N272A	D27	Lot No.	2.7 V
RP509N281A	C28	Lot No.	RP509N282A	D28	Lot No.	2.8 V
RP509N291A	C29	Lot No.	RP509N292A	D29	Lot No.	2.9 V
RP509N301A	C30	Lot No.	RP509N302A	D30	Lot No.	3.0 V
RP509N311A	C31	Lot No.	RP509N312A	D31	Lot No.	3.1 V
RP509N321A	C32	Lot No.	RP509N322A	D32	Lot No.	3.2 V
RP509N331A	C33	Lot No.	RP509N332A	D33	Lot No.	3.3 V
RP509N111A5	J11	Lot No.	-	-	-	1.15 V

RP509Nxx1B/RP509Nxx2B (Fixed Output Voltage Type) Part Marking List

Product Name	①②③	④⑤	Product Name	①②③	④⑤	V _{SET}
RP509N061B	E06	Lot No.	RP509N062B	F06	Lot No.	0.6 V
RP509N071B	E07	Lot No.	RP509N072B	F07	Lot No.	0.7 V
RP509N081B	E08	Lot No.	RP509N082B	F08	Lot No.	0.8 V
RP509N091B	E09	Lot No.	RP509N092B	F09	Lot No.	0.9 V
RP509N101B	E10	Lot No.	RP509N102B	F10	Lot No.	1.0 V
RP509N111B	E11	Lot No.	RP509N112B	F11	Lot No.	1.1 V
RP509N121B	E12	Lot No.	RP509N122B	F12	Lot No.	1.2 V
RP509N131B	E13	Lot No.	RP509N132B	F13	Lot No.	1.3 V
RP509N141B	E14	Lot No.	RP509N142B	F14	Lot No.	1.4 V
RP509N151B	E15	Lot No.	RP509N152B	F15	Lot No.	1.5 V
RP509N161B	E16	Lot No.	RP509N162B	F16	Lot No.	1.6 V
RP509N171B	E17	Lot No.	RP509N172B	F17	Lot No.	1.7 V
RP509N181B	E18	Lot No.	RP509N182B	F18	Lot No.	1.8 V
RP509N191B	E19	Lot No.	RP509N192B	F19	Lot No.	1.9 V
RP509N201B	E20	Lot No.	RP509N202B	F20	Lot No.	2.0 V
RP509N211B	E21	Lot No.	RP509N212B	F21	Lot No.	2.1 V
RP509N221B	E22	Lot No.	RP509N222B	F22	Lot No.	2.2 V
RP509N231B	E23	Lot No.	RP509N232B	F23	Lot No.	2.3 V
RP509N241B	E24	Lot No.	RP509N242B	F24	Lot No.	2.4 V
RP509N251B	E25	Lot No.	RP509N252B	F25	Lot No.	2.5 V
RP509N261B	E26	Lot No.	RP509N262B	F26	Lot No.	2.6 V
RP509N271B	E27	Lot No.	RP509N272B	F27	Lot No.	2.7 V
RP509N281B	E28	Lot No.	RP509N282B	F28	Lot No.	2.8 V
RP509N291B	E29	Lot No.	RP509N292B	F29	Lot No.	2.9 V
RP509N301B	E30	Lot No.	RP509N302B	F30	Lot No.	3.0 V
RP509N311B	E31	Lot No.	RP509N312B	F31	Lot No.	3.1 V
RP509N321B	E32	Lot No.	RP509N322B	F32	Lot No.	3.2 V
RP509N331B	E33	Lot No.	RP509N332B	F33	Lot No.	3.3 V
RP509N111B5	K11	Lot No.	-	-	-	1.15 V
RP509N131B5	K12	Lot No.	RP509N132B5	K13	Lot No.	1.35 V

PART MARKINGS

RP509N

MK-RP509N-JE-D

RP509N00XC/RP509N00XD (Adjustable Output Voltage Type) Part Marking List

Product Name	①②③	④⑤	Product Name	①②③	④⑤	V _{SET}
RP509N001C	G01	Lot No.	RP509N002C	G02	Lot No.	-
RP509N001D	H01	Lot No.	RP509N002D	H02	Lot No.	-

1. The products and the product specifications described in this document are subject to change or discontinuation of production without notice for reasons such as improvement. Therefore, before deciding to use the products, please refer to our sales representatives for the latest information thereon.
2. The materials in this document may not be copied or otherwise reproduced in whole or in part without the prior written consent of us.
3. This product and any technical information relating thereto are subject to complementary export controls (so-called KNOW controls) under the Foreign Exchange and Foreign Trade Law, and related politics ministerial ordinance of the law. (Note that the complementary export controls are inapplicable to any application-specific products, except rockets and pilotless aircraft, that are insusceptible to design or program changes.) Accordingly, when exporting or carrying abroad this product, follow the Foreign Exchange and Foreign Trade Control Law and its related regulations with respect to the complementary export controls.
4. The technical information described in this document shows typical characteristics and example application circuits for the products. The release of such information is not to be construed as a warranty of or a grant of license under our or any third party's intellectual property rights or any other rights.
5. The products listed in this document are intended and designed for use as general electronic components in standard applications (office equipment, telecommunication equipment, measuring instruments, consumer electronic products, amusement equipment etc.). Those customers intending to use a product in an application requiring extreme quality and reliability, for example, in a highly specific application where the failure or misoperation of the product could result in human injury or death should first contact us.
 - Aerospace Equipment
 - Equipment Used in the Deep Sea
 - Power Generator Control Equipment (nuclear, steam, hydraulic, etc.)
 - Life Maintenance Medical Equipment
 - Fire Alarms / Intruder Detectors
 - Vehicle Control Equipment (automotive, airplane, railroad, ship, etc.)
 - Various Safety Devices
 - Traffic control system
 - Combustion equipment

In case your company desires to use this product for any applications other than general electronic equipment mentioned above, make sure to contact our company in advance. Note that the important requirements mentioned in this section are not applicable to cases where operation requirements such as application conditions are confirmed by our company in writing after consultation with your company.

6. We are making our continuous effort to improve the quality and reliability of our products, but semiconductor products are likely to fail with certain probability. In order to prevent any injury to persons or damages to property resulting from such failure, customers should be careful enough to incorporate safety measures in their design, such as redundancy feature, fire containment feature and fail-safe feature. We do not assume any liability or responsibility for any loss or damage arising from misuse or inappropriate use of the products.
7. The products have been designed and tested to function within controlled environmental conditions. Do not use products under conditions that deviate from methods or applications specified in this datasheet. Failure to employ the products in the proper applications can lead to deterioration, destruction or failure of the products. We shall not be responsible for any bodily injury, fires or accident, property damage or any consequential damages resulting from misuse or misapplication of the products.
8. **Quality Warranty**
 - 8-1. **Quality Warranty Period**

In the case of a product purchased through an authorized distributor or directly from us, the warranty period for this product shall be one (1) year after delivery to your company. For defective products that occurred during this period, we will take the quality warranty measures described in section 8-2. However, if there is an agreement on the warranty period in the basic transaction agreement, quality assurance agreement, delivery specifications, etc., it shall be followed.
 - 8-2. **Quality Warranty Remedies**

When it has been proved defective due to manufacturing factors as a result of defect analysis by us, we will either deliver a substitute for the defective product or refund the purchase price of the defective product.

Note that such delivery or refund is sole and exclusive remedies to your company for the defective product.
 - 8-3. **Remedies after Quality Warranty Period**

With respect to any defect of this product found after the quality warranty period, the defect will be analyzed by us. On the basis of the defect analysis results, the scope and amounts of damage shall be determined by mutual agreement of both parties. Then we will deal with upper limit in Section 8-2. This provision is not intended to limit any legal rights of your company.
9. Anti-radiation design is not implemented in the products described in this document.
10. The X-ray exposure can influence functions and characteristics of the products. Confirm the product functions and characteristics in the evaluation stage.
11. WLCSP products should be used in light shielded environments. The light exposure can influence functions and characteristics of the products under operation or storage.
12. Warning for handling Gallium and Arsenic (GaAs) products (Applying to GaAs MMIC, Photo Reflector). These products use Gallium (Ga) and Arsenic (As) which are specified as poisonous chemicals by law. For the prevention of a hazard, do not burn, destroy, or process chemically to make them as gas or power. When the product is disposed of, please follow the related regulation and do not mix this with general industrial waste or household waste.
13. Please contact our sales representatives should you have any questions or comments concerning the products or the technical information.



Nisshinbo Micro Devices Inc.

Official website

<https://www.nisshinbo-microdevices.co.jp/en/>

Purchase information

<https://www.nisshinbo-microdevices.co.jp/en/buy/>