



BZT52B-Series

Small Signal Zener Diodes

SOD-123 Plastic-Encapsulate Diodes

6 NH) &6 &J \$!6 NH) &6 +) N9B9F DIODE

SOD-123



FEATURES

- V[caÁ [, ^!Áã • q aã } kT aãÁ €€ Y
- Y aã^Á^} ^!Á^ç^! • ^Áç [ca^Áã * ^ÁçXÁ Á í XÈ
- Ú{ aãÁ aã caÁ aã aã ^Á ~ aã |Á |Á ~ | aãÁ { [~ } c^áÁ^ã } È
- V[|Áã &Áã] | | ca aã | t GÁ

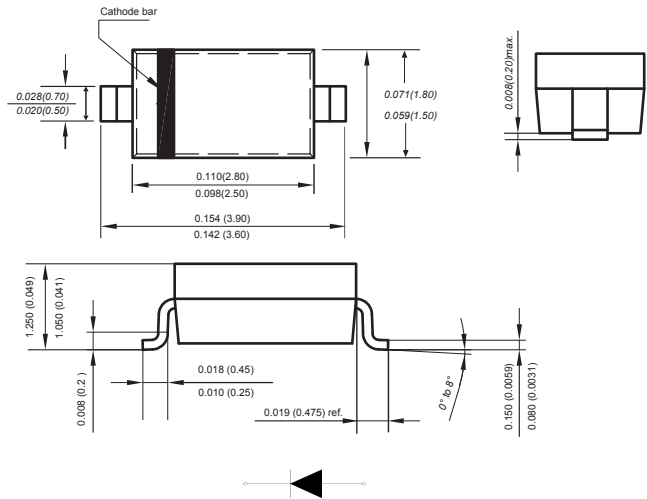

Dimensions in inches and (millimeters)

Mechanical Data

Case : SOD-123

Terminals : Solderable per MIL-STD-750, Method 2026

Polarity : Polarity symbol marking on body

Mounting Position : Any

Weight : 0.00056 ounce, 0.016 grams

Maximum Ratings (Ta=25 °C unless otherwise specified)

Characteristic	Symbol	Value	Unit
Forward Voltage (Note 2) @ I _F = 10mA	V _F	0.9	V
Power Dissipation (Note 1)	P _d	50	mW
Thermal Resistance from Junction to Ambient	R _{θJA}	31	°C/W
Junction Temperature	T _j	150	°C
Storage Temperature Range	T _{stg}	-55 ~ +150	°C

Notes: 1. Thermal resistance from junction to ambient at P.C.B. mounted with 2.0" X 2.0" (5 X 5 cm) copper areas pads.

2. Short duration test pulse used to minimize self-heating effect

3. f = 1 kHz



BZT52B-Series

Small Signal Zener Diodes

ELECTRICAL CHARACTERISTICS @ Ta=25°C unless otherwise specified

Type	Marking	Zener Voltage Range ⁽¹⁾			I _{ZT} (mA)	Dynamic Impedance Z _{ZT} (at I _{ZT}) Max (Ω)	Reverse Current	
		V _{ZT} (at I _{ZT})					I _R	at V _R
		Min (V)	Nom (V)	Max (V)			Max (μA)	(V)
BZT52B2V0	2WY	1.96	2	2.04	5	100	120	0.5
BZT52B2V2	2WZ	2.16	2.2	2.24	5	100	120	0.7
BZT52B2V4	2WX	2.35	2.4	2.45	5	100	120	1
BZT52B2V7	2W1	2.65	2.7	2.75	5	110	120	1
BZT52B3V0	2W2	2.94	3	3.06	5	120	50	1
BZT52B3V3	2W3	3.23	3.3	3.37	5	130	20	1
BZT52B3V6	2W4	3.53	3.6	3.67	5	130	10	1
BZT52B3V9	2W5	3.82	3.9	3.98	5	130	5	1
BZT52B4V3	2W6	4.21	4.3	4.39	5	130	5	1
BZT52B4V7	2W7	4.61	4.7	4.79	5	130	2	1
BZT52B5V1	2W8	5	5.1	5.20	5	130	2	1.5
BZT52B5V6	2W9	5.49	5.6	5.71	5	80	1	2.5
BZT52B6V2	2WA	6.08	6.2	6.32	5	50	1	3
BZT52B6V8	2WB	6.66	6.8	6.94	5	30	0.5	3.5
BZT52B7V5	2WC	7.35	7.5	7.65	5	30	0.5	4
BZT52B8V2	2WD	8.04	8.2	8.36	5	30	0.5	5
BZT52B9V1	2WE	8.92	9.1	9.28	5	30	0.5	6
BZT52B10	2WF	9.8	10	10.2	5	30	0.1	7
BZT52B11	2WG	10.78	11	11.22	5	30	0.1	8
BZT52B12	2WH	11.76	12	12.24	5	35	0.1	9
BZT52B13	2WI	12.74	13	13.26	5	35	0.1	10
BZT52B15	2WJ	14.7	15	15.3	5	40	0.1	11
BZT52B16	2WK	15.68	16	16.32	5	40	0.1	12
BZT52B18	2WL	17.64	18	18.36	5	45	0.1	13
BZT52B20	2WM	19.6	20	20.4	5	50	0.1	15
BZT52B22	2WN	21.56	22	22.44	5	55	0.1	17
BZT52B24	2WO	23.52	24	24.48	5	60	0.1	19
BZT52B27	2WP	26.46	27	27.54	5	70	0.1	21
BZT52B30	2WQ	29.4	30	30.6	5	80	0.1	23
BZT52B33	2WR	32.34	33	33.66	5	80	0.1	25
BZT52B36	2WS	35.28	36	36.72	5	90	0.1	27
BZT52B39	2WT	38.22	39	39.78	2.5	100	2	30
BZT52B43	2WU	42.14	43	43.86	2.5	130	2	33
BZT52B47	2WV	46.06	47	47.94	2.5	150	2	36
BZT52B51	2WW	49.98	51	52.02	2.5	180	1	39
BZT52B56	2X1	54.88	56	57.12	2.5	180	1	43
BZT52B62	2X2	60.76	62	63.24	2.5	200	0.2	47
BZT52B68	2X3	66.64	68	69.36	2.5	250	0.2	52
BZT52B75	2X4	73.5	75	76.5	2.5	300	0.2	57

(1) V_{ZT} is tested with pulses (20 ms)



BZT52B-Series

Small Signal Zener Diodes

Typical Characteristics

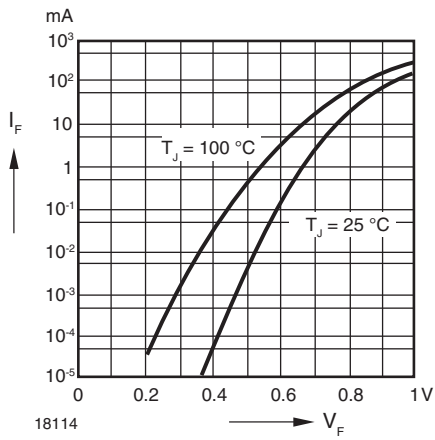

Fig. 1 - Forward characteristics

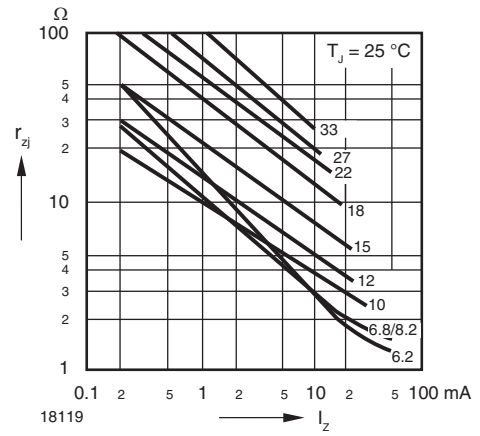

Fig. 4 - Dynamic Resistance vs. Zener Current

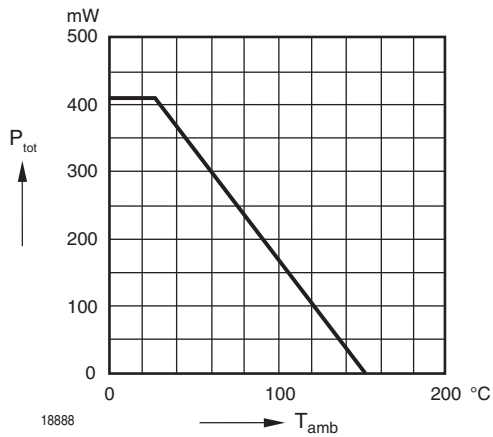

Fig. 2 - Admissible Power Dissipation vs. Ambient Temperature

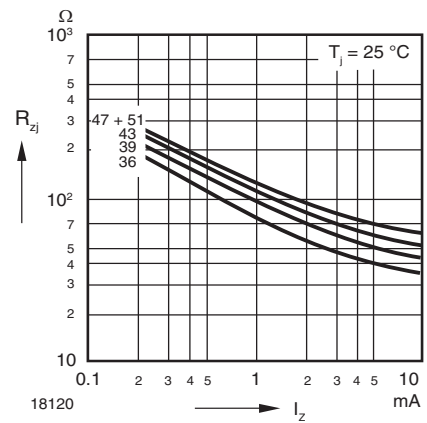

Fig. 5 - Dynamic Resistance vs. Zener Current

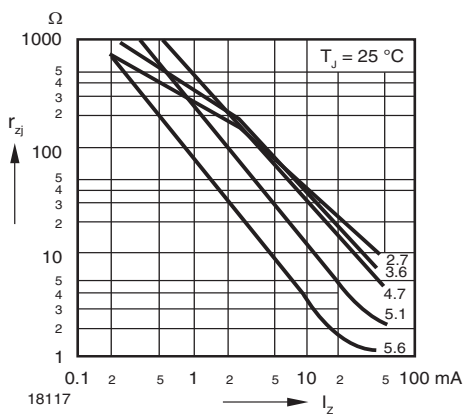

Fig. 3 - Dynamic Resistance vs. Zener Current

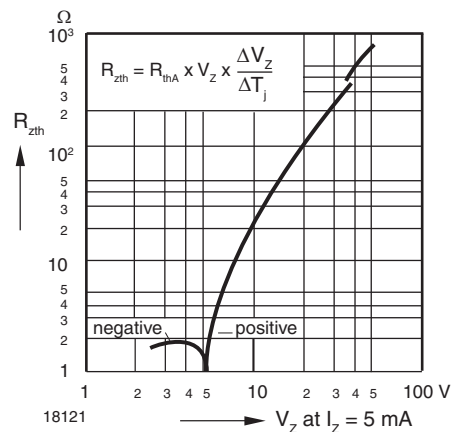

Fig. 6 - Thermal Differential Resistance vs. Zener Voltage

Typical Characteristics

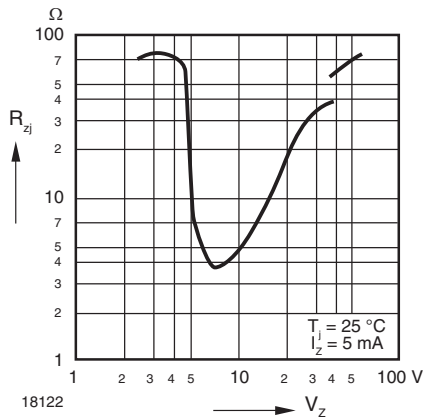

Fig. 7 - Dynamic Resistance vs. Zener Voltage

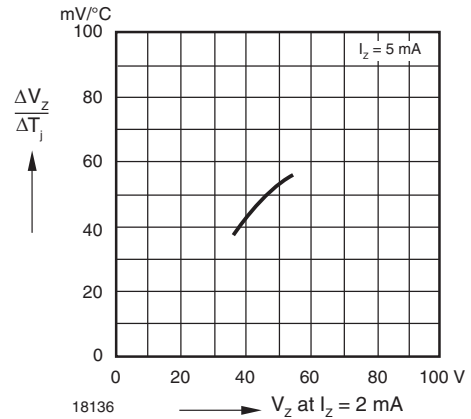

Fig. 10 - Temperature Dependence of Zener Voltage vs. Zener Voltage

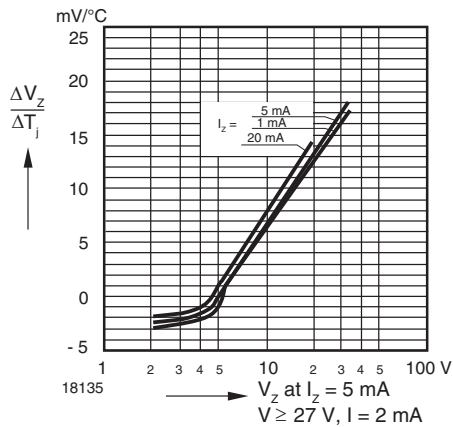

Fig. 8 - Temperature Dependence of Zener Voltage vs. Zener Voltage

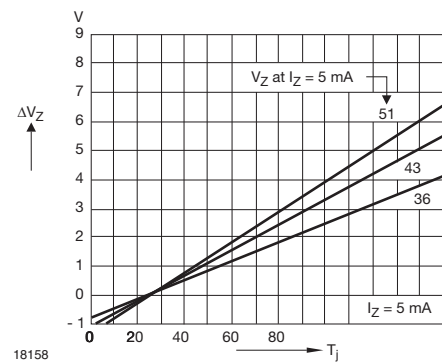

Fig. 11 - Change of Zener Voltage vs. Junction Temperature

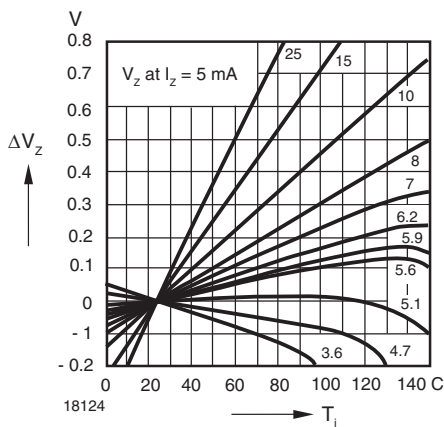

Fig. 9 - Change of Zener Voltage vs. Junction Temperature

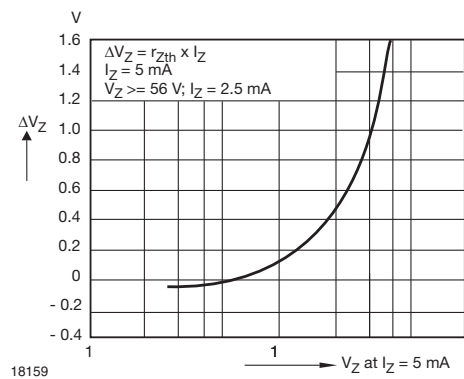

Fig. 12 - Change of Zener Voltage from Turn-on up to the Point of Thermal Equilibrium vs. Zener Voltage

Typical Characteristics

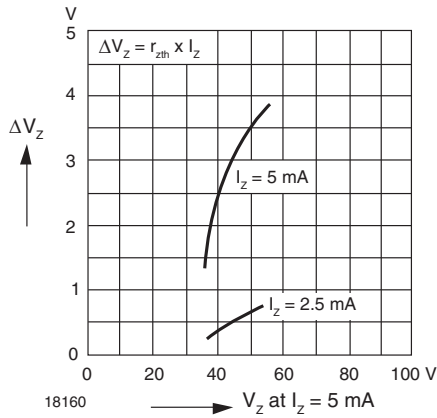

Fig. 13 - Change of Zener Voltage from Turn-on up to the Point of Thermal Equilibrium vs. Zener Voltage

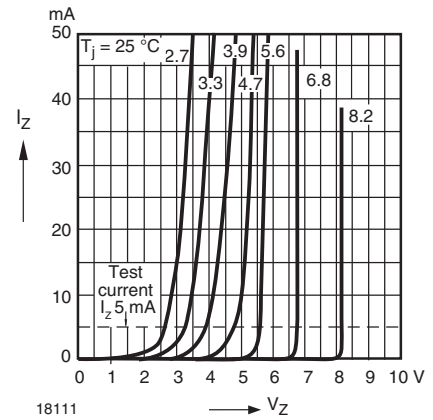

Fig. 14 - Breakdown Characteristics

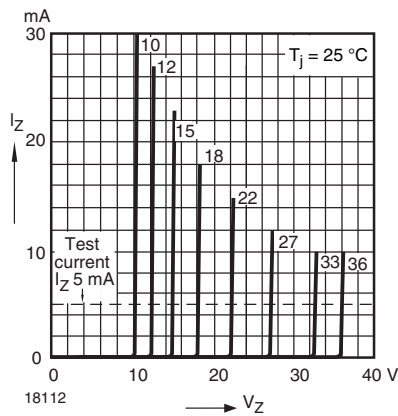

Fig. 15 - Breakdown Characteristics

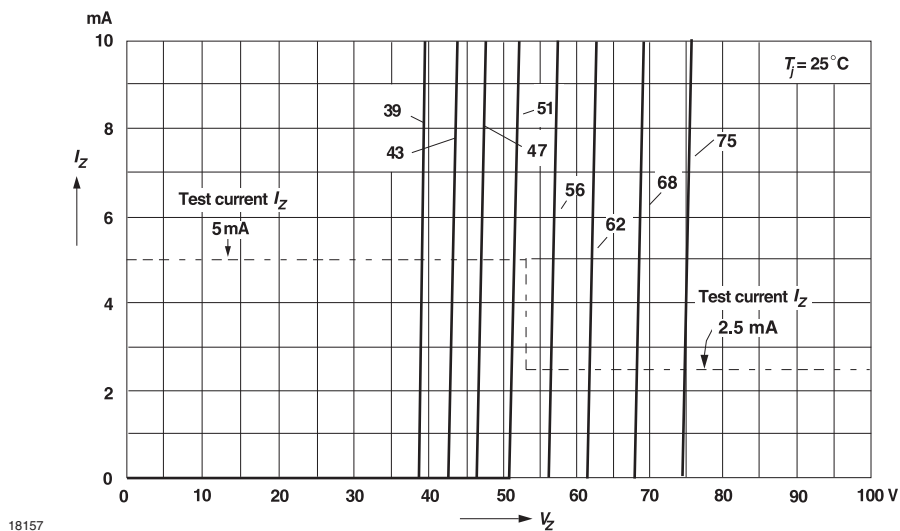

Fig. 16 - Breakdown Characteristics

The curve above is for reference only.



BZT52B-Series

Small Singnal Zener Diodes

Packing information

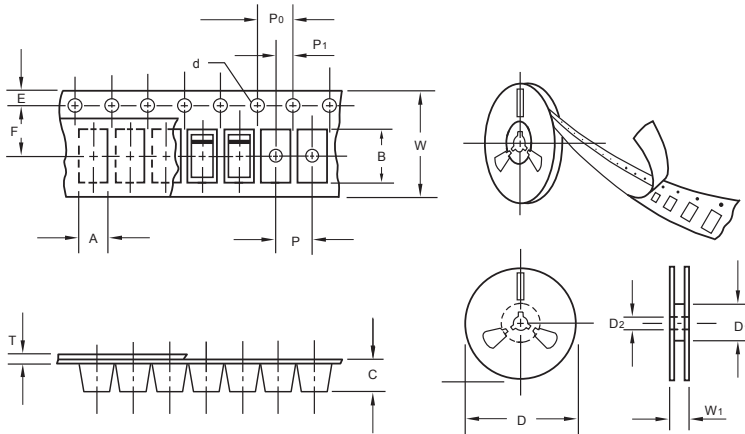

unit:mm

Item	Symbol	Tolerance	SOD-123
Carrier width	A	0.1	2.1
Carrier length	B	0.1	4.0
Carrier depth	C	0.1	1.60
Sprocket hole	d	0.05	1.55
7" Reel outside diameter	D	2.0	178.00
7" Reel inner diameter	D ₁	min	50.0
Feed hole diameter	D ₂	0.5	13.00
Sprocket hole position	E	0.1	1.75
Punch hole position	F	0.1	3.50
Punch hole pitch	P	0.1	4.00
Sprocket hole pitch	P ₀	0.1	4.00
Embossment center	P ₁	0.1	2.00
Overall tape thickness	T	0.1	0.25
Tape width	W	0.3	8.15
Reel width	W ₁	1.0	10.5

Note: Devices are packed in accordance with EIA standard RS-481-A and specifications listed above.

Reel packing

PACKAGE	REEL SIZE	REEL (pcs)	COMPONENT SPACING (m/m)	BOX (pcs)	INNER BOX (m/m)	REEL DIA. (m/m)	CARTON SIZE (m/m)	CARTON (pcs)	APPROX. GROSS WEIGHT (kg)
SOD-123	7"	3,000	4.0	45,000	210*208*203	178	430*430*235	180,000	9.0

Suggested Pad Layout

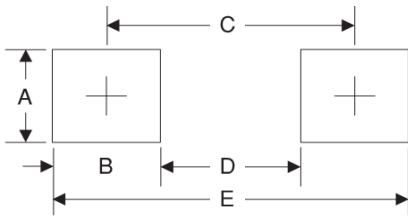

Symbol	Unit (mm)	Unit (inch)
A	1.2	0.047
B	1.2	0.047
C	3.2	0.126
D	2.0	0.079
E	4.4	0.173