

March 1997

CMOS Manchester Encoder-Decoder

Features

- Support of MIL-STD-1553
- Data Rate (15531B) 2.5 Megabit/Sec
- Data Rate (15531)..... 1.25 Megabit/Sec
- Variable Frame Length to 32 Bits
- Sync Identification and Lock-In
- Separate Manchester II Encode, Decode
- Low Operating Power 50mW at 5V

Ordering Information

PACKAGE	TEMP. RANGE	1.25MBIT /SEC	2.5MBIT /SEC	PKG. NO.
PDIP	-40°C to +85°C	-	HD3-15531B-9	E40.6
CERDIP	-40°C to +85°C	HD1-15531-9	HD1-15531B-9	F40.6
	-55°C to +125°C	HD1-15531-8	HD1-15531B-8	F40.6
DESC (CERDIP)	-55°C to +125°C	5962-9054901MQA	HD1-15531	F40.6
	-55°C to +125°C	5962-9054902MQA	HD1-15531B	F40.6

Description

The Harris HD-15531 is a high performance CMOS device intended to service the requirements of MIL-STD-1553 and similar Manchester II encoded, time division multiplexed serial data protocols. This LSI chip is divided into two sections, an Encoder and a Decoder. These sections operate independently of each other, except for the master reset and word length functions. This circuit provides many of the requirements of MIL-STD-1553. The Encoder produces the sync pulse and the parity bit as well as the encoding of the data bits. The Decoder recognizes the sync pulse and identifies it as well as decoding the data bits and checking parity.

The HD-15531 also surpasses the requirements of MIL-STD-1553 by allowing the word length to be programmable (from 2 to 28 data bits). A frame consists of three bits for sync followed by the data word (2 to 28 data bits) followed by one bit of parity, thus, the frame length will vary from 6 to 32 bit periods. This chip also allows selection of either even or odd parity for the Encoder and Decoder separately.

This integrated circuit is fully guaranteed to support the 1MHz data rate of MIL-STD-1553 over both temperature and voltage. For high speed applications the 15531B will support a 2.5 Megabit/sec data rate.

The HD-15531 can also be used in many party line digital data communications applications, such as a local area network or an environmental control system driven from a single twisted pair of fiber optic cable throughout a building.

HD-15531

Pinout

HD-15531 (CERDIP, PDIP)
TOP VIEW

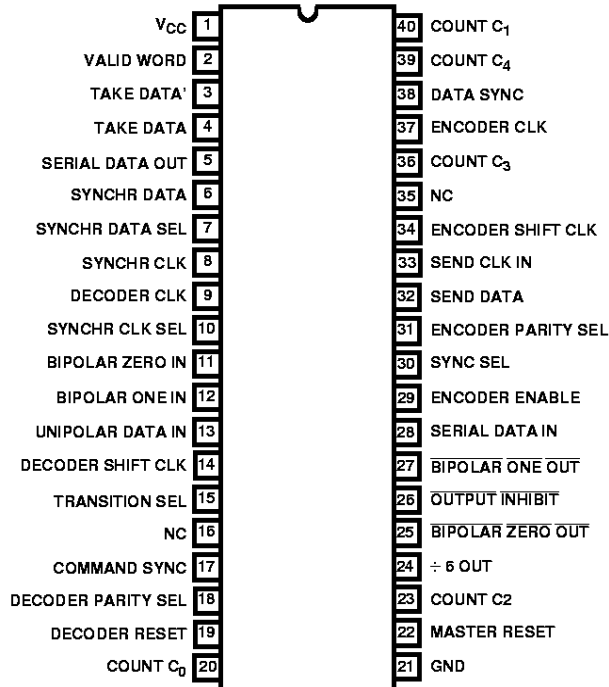

Block Diagrams

ENCODER

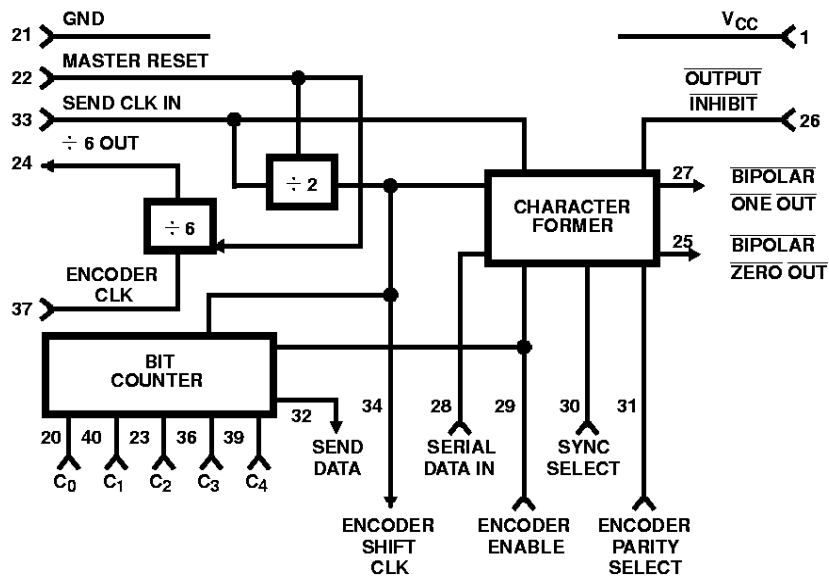

HD-15531

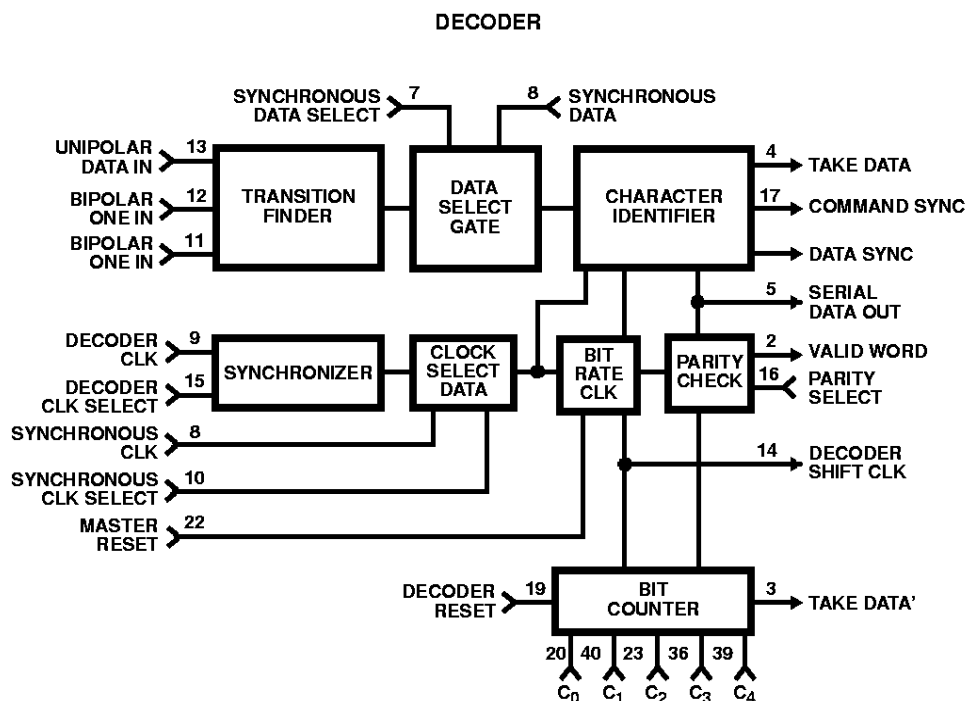

Pin Description

PIN NUMBER	TYPE	NAME	SECTION	DESCRIPTION
1		V _{CC}	Both	Positive supply pin. A 0.1μF decoupling capacitor from V _{CC} (pin 1) to GROUND (pin 21) is recommended.
2	O	VALID WORD	Decoder	Output high indicates receipt of a valid word, (valid parity and no Manchester errors).
3	O	TAKE DATA'	Decoder	A continuous, free running signal provided for host timing or data handling. When data is present on the bus, this signal will be synchronized to the incoming data and will be identical to TAKE DATA.
4	O	TAKE DATA	Decoder	Output is high during receipt of data after identification of a valid sync pulse and two valid Manchester bits.
5	O	SERIAL DATA OUT	Decoder	Delivers received data in correct NRZ format.
6	I	SYNCHRONOUS DATA	Decoder	Input presents Manchester data directly to character identification logic. SYNCHRONOUS DATA SELECT must be held high to use this input. If not used, this pin must be held high.
7	I	SYNCHRONOUS DATA SELECT	Decoder	In high state allows the synchronous data to enter the character identification logic. Tie this input low for asynchronous data.
8	I	SYNCHRONOUS CLOCK	Decoder	Input provides externally synchronized clock to the decoder, for use when receiving synchronous data. This input must be tied high when not in use.
9	I	DECODER CLOCK	Decoder	Input drives the transition finder, and the synchronizer which in turn supplies the clock to the balance of the decoder. Input a frequency equal to 12X the data rate.
10	I	SYNCHRONOUS CLOCK SELECT	Decoder	In high state directs the SYNCHRONOUS CLOCK to control the decoder character identification logic. A low state selects the DECODER CLOCK.
11	I	BIPOLAR ZERO IN	Decoder	A high input should be applied when the bus is in its negative state. This pin must be held high when the unipolar input is used.
12	I	BIPOLAR ONE IN	Decoder	A high input should be applied when the bus is in its positive state. This pin must be held low when the unipolar input is used.
13	I	UNIPOLAR DATA IN	Decoder	With pin 11 high and pin 12 low, this pin enters unipolar data into the transition finder circuit. If not used this input must be held low.

Pin Description (Continued)

PIN NUMBER	TYPE	NAME	SECTION	DESCRIPTION
14	O	DECODER SHIFT CLOCK	Decoder	Output which delivers a frequency (DECODER CLOCK + 1 2), synchronous by the recovered serial data stream.
15	I	TRANSITION SELECT	Decoder	A high input to this pin causes the transition finder to synchronize on every transition of input data. A low input causes the transition finder to synchronize only on mid-bit transitions.
16		NC	Blank	Not connected.
17	O	COMMAND SYNC	Decoder	Output of a high from this pin occurs during output of decoded data which was preceded by a Command (or Status) synchronizing character.
18	I	DECODER PARITY SELECT	Decoder	An input for parity sense, calling for even parity with input high and odd parity with input low.
19	I	DECODER RESET	Decoder	A high input to this pin during a rising edge of DECODER SHIFT CLOCK resets the decoder bit counting logic to a condition ready for a new word.
20	I	COUNT C0	Both	One of five binary inputs which establish the total bit count to be encoded or decoded.
21		GROUND	Both	Supply pin.
22	I	MASTER RESET	Both	A high on this pin clears 2:1 counters in both encoder and decoder, and resets the ÷ 6 circuit.
23	I	COUNT C2	Both	See pin 20.
24	O	÷ 6 OUT	Encoder	Output from 6:1 divider which is driven by the ENCODER CLOCK.
25	O	BIPOLAR ZERO OUT	Encoder	An active low output designed to drive the zero or negative sense of a bipolar line driver.
26	I	OUTPUT INHIBIT	Encoder	A low on this pin forces pin 25 and 27 high, the inactive states.
27	O	BIPOLAR ONE OUT	Encoder	An active low output designed to drive the one or positive sense of a bipolar line driver.
28	I	SERIAL DATA IN	Encoder	Accepts a serial data stream at a data rate equal to ENCODER SHIFT CLOCK.
29	I	ENCODER ENABLE	Encoder	A high on this pin initiates the encode cycle. (Subject to the preceding cycle being complete).
30	I	SYNC SELECT	Encoder	Actuates a Command sync for an input high and Data sync for an input low.
31	I	ENCODER PARITY SELECT	Encoder	Sets transmit parity odd for a high input, even for a low input.
32	O	SEND DATA	Encoder	Is an active high output which enables the external source of serial data.
33	I	SEND CLOCK IN	Encoder	Clock input at a frequency equal to the data rate X2, usually driven by ÷ 6 output.
34	O	ENCODER SHIFT CLOCK	Encoder	Output for shifting data into the Encoder. The Encoder samples SDI pin-28 on the low-to-high transition of ESC.
35		NC	Blank	Not connected.
36	I	COUNT C3	Both	See pin 20.
37	I	ENCODER CLOCK	Encoder	Input to the 6:1 divider, a frequency equal to 12 times the data rate is usually input here.
38	O	DATA SYNC	Decoder	Output of a high from this pin occurs during output of decoded data which was preceded by a data synchronizing character.
39	I	COUNT C4	Both	See pin 20.
40	I	COUNT C1	Both	See pill 20.

Encoder Operation

The Encoder requires a single clock with a frequency of twice the desired data rate applied at the SEND CLOCK input. An auxiliary divide by six counter is provided on chip which can be utilized to produce the SEND CLOCK by dividing the DECODER CLOCK. The frame length is set by programming the COUNT inputs. Parity is selected by programming ENCODER PARITY SELECT high for odd parity or low for even parity.

The Encoder's cycle begins when ENCODER ENABLE is high during a falling edge of ENCODER SHIFT CLOCK ①. This cycle lasts for one word length or K + 4 ENCODER SHIFT CLOCK periods, where K is the number of bits to be sent. At the next low-to-high transition of the ENCODER SHIFT CLOCK, a high SYNC SELECT input actuates a Command sync or a low will produce a Data sync for the word ②. When the Encoder is ready to accept data, the SEND DATA output will go high for K ENCODER SHIFT CLOCK periods ④. During these K periods the data should

be clocked into the SERIAL DATA input with every high-to-low transition of the ENCODER SHIFT CLOCK ③ - ④ so it can be sampled on the low-to-high transition. After the sync and Manchester II encoded data are transmitted through the BIPOLAR ONE and BIPOLAR ZERO outputs, the Encoder adds on an additional bit with the parity for that word ⑤. If ENCODER ENABLE is held high continuously, consecutive words will be encoded without an interframe gap. ENCODER ENABLE must go low by time ⑤ (as shown) to prevent a consecutive word from being encoded. At any time a low on OUTPUT INHIBIT input will force both bipolar outputs to a high state but will not affect the Encoder in any other way.

To abort the Encoder transmission, a positive pulse must be applied at MASTER RESET. Any time after or during this pulse, a low-to-high transition on SEND CLOCK clears the internal counters and initializes the Encoder for a new word.

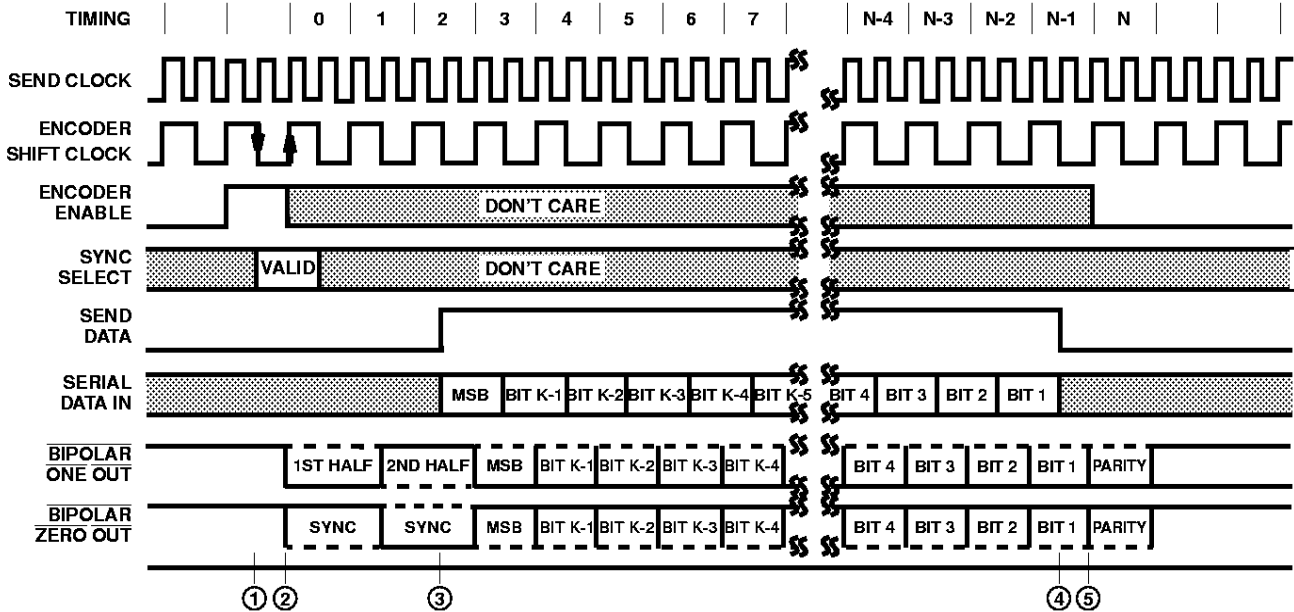

FIGURE 1. ENCODER

Decoder Operation

To operate the Decoder asynchronously requires a single clock with a frequency of 12 times the desired data rate applied at the DECODER CLOCK input. To operate the Decoder synchronously requires a SYNCHRONOUS CLOCK at a frequency 2 times the data rate which is synchronized with the data at every high-to-low transition applied to the SYNCHRONOUS CLK input. The Manchester II coded data can be presented to the Decoder asynchronously in one of two ways. The BIPOLAR ONE and BIPOLAR ZERO inputs will accept data from a comparator sensed transformer coupled bus as specified in Military Spec 1553. The UNIPOLAR DATA input can only accept noninverted Manchester II coded data. (e.g., from BIPOLAR

ONE OUT on an Encoder through an inverter to Unipolar Data Input).

The Decoder is free running and continuously monitors its data input lines for a valid sync character and two valid Manchester data bits to start an output cycle. When a valid sync is recognized ①, the type of sync is indicated by a high level at either COMMAND SYNC or DATA SYNC output. If the sync character was a command sync the COMMAND SYNC output will go high ② and remain high for K SHIFT CLOCK periods ③, where K is the number of bits to be received. If the sync character was a data sync, the DATA SYNC output will go high. The TAKE DATA output will go high and remain high ② - ③ while the Decoder is transmit-

ting the decoded data through SERIAL DATA OUT. The decoded data available at SERIAL DATA OUT is in NRZ format. The DECODER SHIFT CLOCK is provided so that the decoded bits can get shifted into an external register on every low-to-high transition of this clock (2) - (3). Note that DECODER SHIFT CLOCK may adjust its phase up until the time that TAKE DATA goes high.

After all K decoded bits have been transmitted (3) the data is checked for parity. A high input on DECODER PARITY SELECT will set the Decoder to check for even parity or a low input will set the Decoder to check for odd parity. A high

on VALID WORD output (4) indicates a successful reception of a word without any Manchester or parity errors. At this time the Decoder is looking for a new sync character to start another output sequence. VALID WORD will go low approximately $K + 4$ DECODER SHIFT CLOCK periods after it goes high, if not reset low sooner by a valid sync and two valid Manchester bits as shown (1).

At any time in the above sequence a high input on DECODER RESET during a low-to-high transition of DECODER SHIFT CLOCK will abort transmission and initialize the Decoder to start looking for a new sync character.

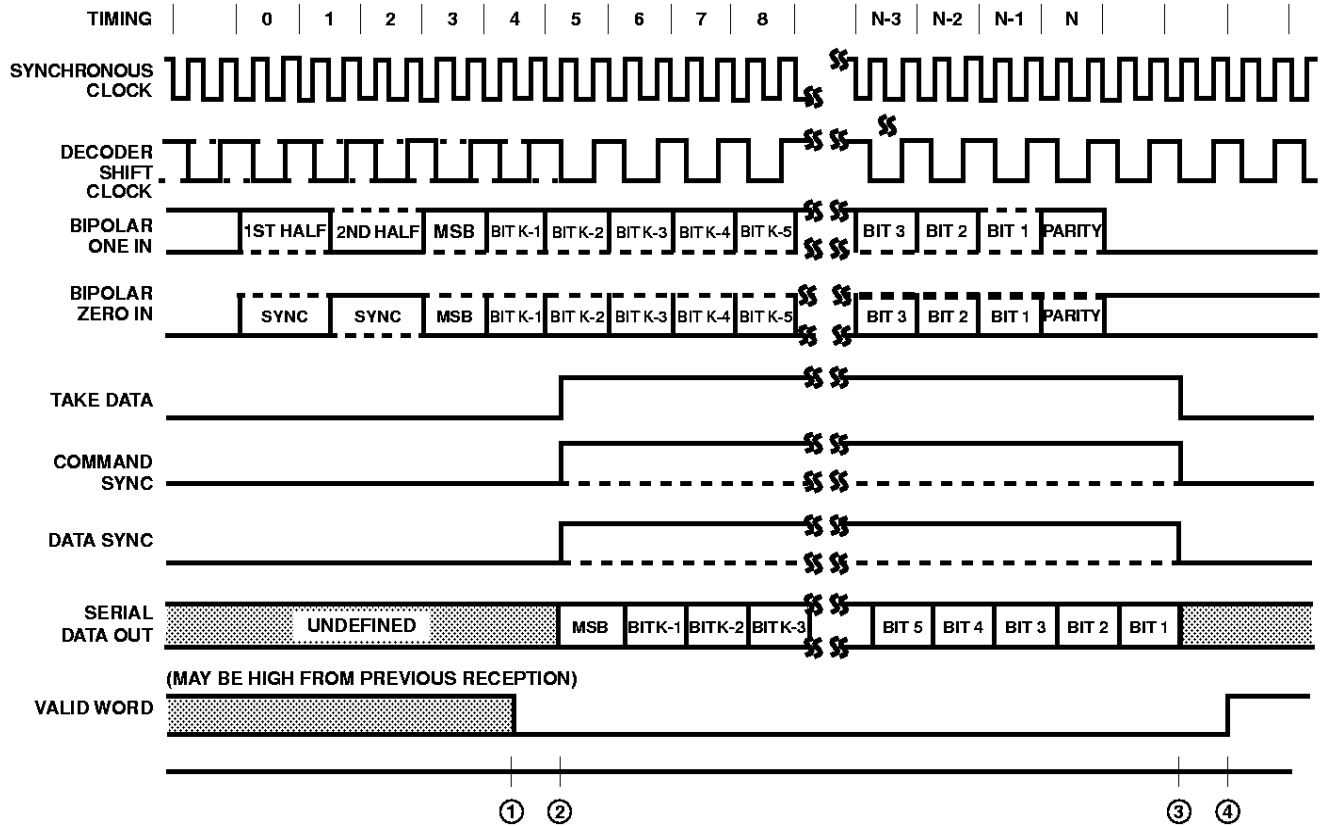

FIGURE 2. DECODER

Frame Counter

DATA BITS	FRAME LENGTH (BIT PERIODS)	PIN WORD				
		C ₄	C ₃	C ₂	C ₁	C ₀
2	6	L	L	H	L	H
3	7	L	L	H	H	L
4	8	L	L	H	H	H
5	9	L	H	L	L	L
6	10	L	H	L	L	H
7	11	L	H	L	H	L
8	12	L	H	L	H	H
9	13	L	H	H	L	L
10	14	L	H	H	L	H
11	15	L	H	H	H	L
12	16	L	H	H	H	H
13	17	H	L	L	L	L
14	18	H	L	L	L	H
15	19	H	L	L	H	L
16	20	H	L	L	H	H
17	21	H	L	H	L	L
18	22	H	L	H	L	H
19	23	H	L	H	H	L
20	24	H	L	H	H	H
21	25	H	H	L	L	L
22	26	H	H	L	L	H
23	27	H	H	L	H	L
24	28	H	H	L	H	H
25	29	H	H	H	L	L
26	30	H	H	H	L	H
27	31	H	H	H	H	L
28	32	H	H	H	H	H

NOTE:

1. The above table demonstrates all possible combinations of frame lengths ranging from 6 to 32 bits. The pin word described here is common to both the Encoder and Decoder.

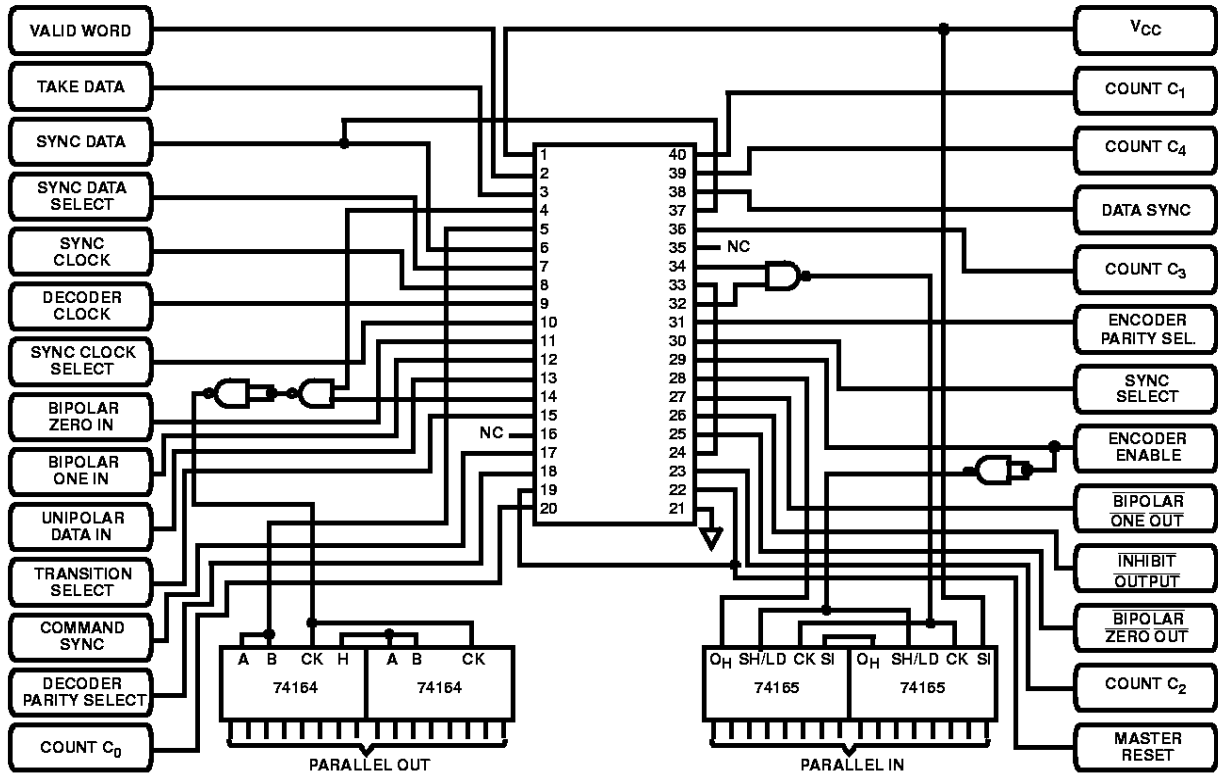

FIGURE 3. HOW TO MAKE OUR MTU LOOK LIKE A MANCHESTER ENCODED UART

Typical Timing Diagrams for a Manchester Encoded UART

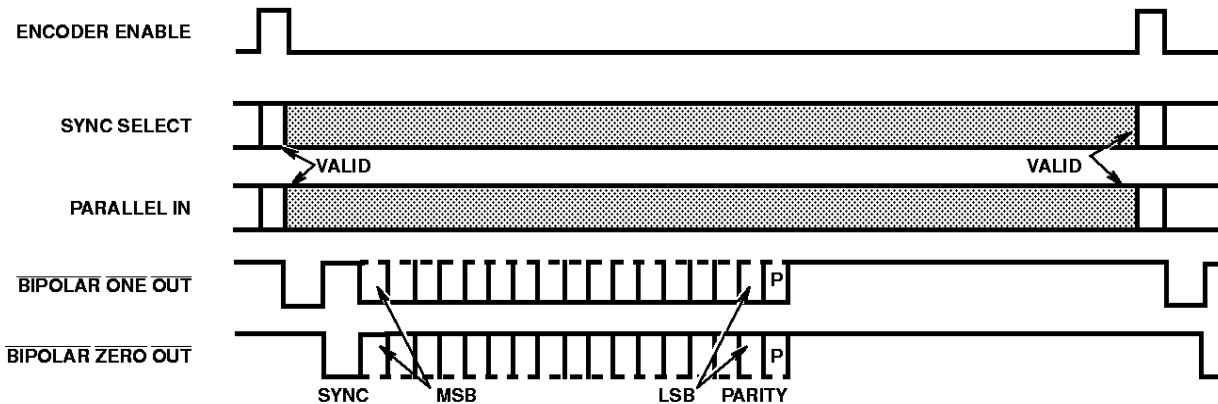

FIGURE 4. ENCODER TIMING

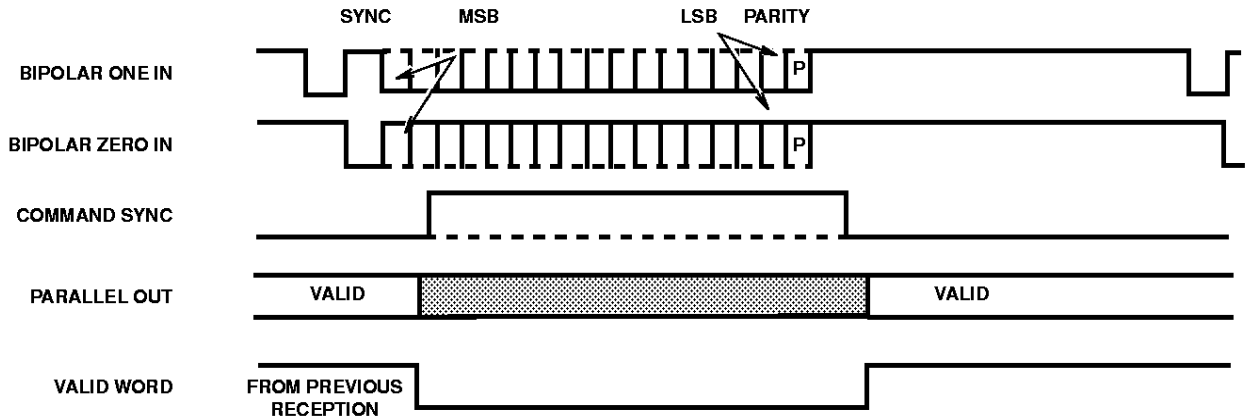

FIGURE 5. DECODER TIMING

MIL-STD-1553

The 1553 Standard defines a time division multiplexed data bus for application within aircraft. The bus is defined to be bipolar, and encoded in a Manchester II format, so no DC component appears on the bus. This allows transformer coupling and excellent isolation among systems and their environment.

The HD-15531 supports the full bipolar configuration, assuming a bus driver configuration similar to that in Figure 1. Bipolar inputs from the bus, like Figure 2, are also accommodated.

The signaling format in MIL-STD-1553 is specified on the assumption that the network of 32 or fewer terminals are controlled by a central control unit by means of Command Words, and Data. Terminals respond with Status Words, and Data. Each word is preceded by a synchronizing pulse, and

followed by parity bit, occupying a total of 20μs. The word formats are shown in Figure 4. The special abbreviations are as follows:

- P Parity, which is defined to be odd, taken across all 17 bits.
- R/T Receive on logical zero, transmit on ONE.
- ME Message Error if logical 1.
- TF Terminal Flag, if set, calls for controller to request self-test data.

The paragraphs above are intended only to suggest the content of MIL-STD-1553, and do not completely describe its bus requirements, timing or protocols.

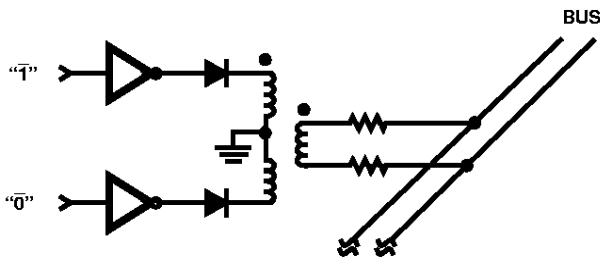

FIGURE 6. SIMPLIFIED MIL-STD-1553 DRIVER

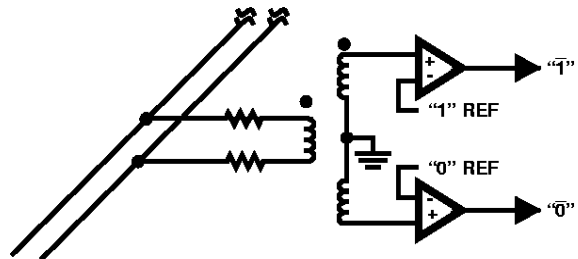

FIGURE 7. SIMPLIFIED MIL-STD-1553 RECEIVER

HD-15531

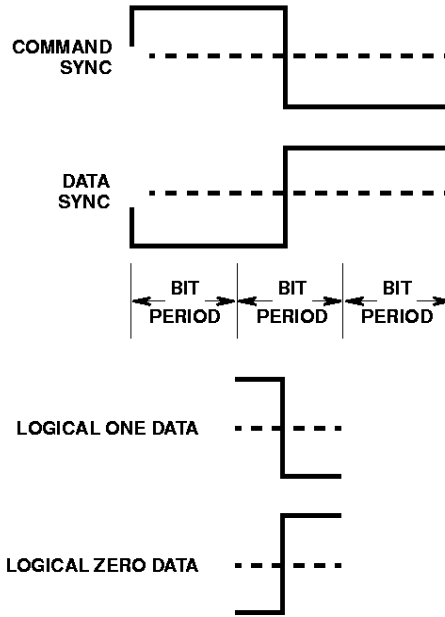
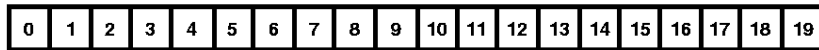
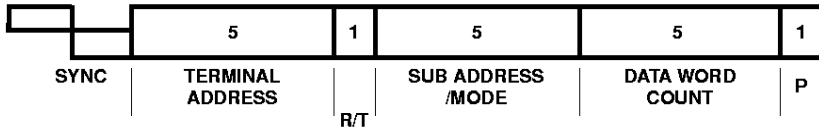

FIGURE 8. MIL-STD-1553 CHARACTER FORMATS



COMMAND WORD (FROM CONTROLLER TO TERMINAL)



DATA WORD (SENT EITHER DIRECTION)

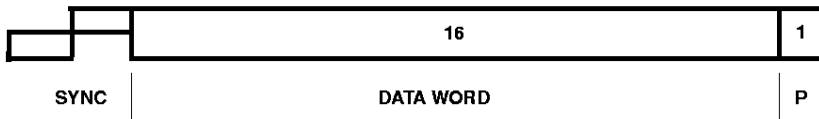

STATUS WORD (FROM TERMINAL TO CONTROLLER)

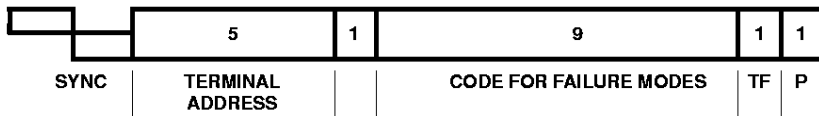

FIGURE 9. MIL-STD-1553 WORD FORMATS

NOTE:

1. This page is a summary of MIL-STD-1553 and is not intended to describe the operation of the HD-15531.

HD-15531

Absolute Maximum Ratings

Supply Voltage +7.0V
 Input, Output or I/O Voltage GND -0.5V to $V_{CC} + 0.5V$
 ESD Classification Class 1

Operating Conditions

Supply Voltage +4.5V to +5.5V
 Operating Temperature Range (T_A)
 HD-15531-9 -40°C to +85°C
 HD-15531-8 -55°C to +125°C
 Encoder/Decoder Clock Rise Time (TECR, TDCR) 8ns Max
 Encoder/Decoder Clock Fall Time (TECF, TDCF) 8ns Max

Thermal Information

Thermal Resistance (Typical)	θ_{JA}	θ_{JC}
CERDIP Package	35°C/W	9°C/W
PDIP Package	50°C/W	N/A
Storage Temperature Range	-65°C to +150°C	
Maximum Junction Temperature		
Ceramic Package	+175°C	
Plastic Package	+150°C	
Maximum Lead Temperature (Soldering 10s)	+300°C	

Die Characteristics

Gate Count 250 Gates
 Sync. Transition Span (TD2) 18 TDC Typical, (Note 1)
 Short Data Transition Span (TD4) 6 TDC Typical, (Note 1)
 Long Data Transition Span (TD5) 12 TDC Typical, (Note 1)

CAUTION: Stresses above those listed in "Absolute Maximum Ratings" may cause permanent damage to the device. This is a stress only rating and operation of the device at these or any other conditions above those indicated in the operational sections of this specification is not implied.

DC Electrical Specifications $V_{CC} = 5.0V \pm 10\%$, $T_A = -40^\circ C$ to $+85^\circ C$ (HD-15531-9)
 $T_A = -55^\circ C$ to $+125^\circ C$ (HD-15531-8)

PARAMETER	SYMBOL	TEST CONDITIONS	MIN	MAX	UNITS
Input LOW Voltage	V_{IL}	$V_{CC} = 4.5V$ and $5.5V$	-	$0.2 V_{CC}$	V
Input HIGH Voltage	V_{IH}	$V_{CC} = 4.5V$ and $5.5V$	$0.7 V_{CC}$	-	V
Input LOW Clock Voltage	V_{ILC}	$V_{CC} = 4.5V$ and $5.5V$	-	GND +0.5	V
Input HIGH Clock Voltage	V_{IHC}	$V_{CC} = 4.5V$ and $5.5V$	$V_{CC} - 0.5$	-	V
Output LOW Voltage	V_{OL}	$I_{OL} = +1.8mA$, $V_{CC} = 4.5V$ (Note 2)	-	0.4	V
Output HIGH Voltage	V_{OH}	$I_{OH} = -3.0mA$, $V_{CC} = 4.5V$ (Note 2)	2.4	-	V
Input Leakage Current	I_I	$V_I = V_{CC}$ or GND, $V_{CC} = 5.5V$	-1.0	+1.0	μA
Standby Supply Current	I_{CCSB}	$V_{IN} = V_{CC} = 5.5V$, Outputs Open	-	2	mA
Operating Power Supply Current	I_{CCOP}	$V_{IN} = V_{CC} = 5.5V$, $f = 15MHz$, Outputs Open	-	10	mA
Functional Test	F_T	(Note 3)	-	-	-

NOTES:

1. TDC = Decoder clock period = $1/FDC$.
2. Interchanging of force and sense conditions is permitted.
3. Tested as follows: $f = 15MHz$, $V_{IH} = 70\% V_{CC}$, $V_{IL} = 20\% V_{CC}$, $C_L = 50pF$, $V_{OH} \geq V_{CC}/2$ and $V_{OL} \leq V_{CC}/2$.

Capacitance $T_A = +25^\circ C$, Frequency = 1MHz

SYMBOL	PARAMETER	TYP	UNITS	TEST CONDITIONS
C_{IN}	Input Capacitance	25	pF	All measurements are referenced to device GND
C_{OUT}	Output Capacitance	25	pF	

HD-15531

AC Electrical Specifications $V_{CC} = 5V \pm 10\%$, $T_A = -40^\circ\text{C}$ to $+85^\circ\text{C}$ (HD-15530-9)
 $T_A = -55^\circ\text{C}$ to $+125^\circ\text{C}$ (HD-15530-8)

SYMBOL	PARAMETER	HD-15531		HD-15531B		UNITS	TEST CONDITIONS (NOTE 2)
		MIN	MAX	MIN	MAX		
ENCODER TIMING							
FEC	Encoder Clock Frequency	-	15	-	30	MHz	$V_{CC} = 4.5V$ and $5.5V$, $C_L = 50pF$
FESC	Send Clock Frequency	-	2.5	-	5.0	MHz	$V_{CC} = 4.5V$ and $5.5V$, $C_L = 50pF$
FED	Encoder Data Rate	-	1.25	-	2.5	MHz	$V_{CC} = 4.5V$ and $5.5V$, $C_L = 50pF$
TMR	Master Reset Pulse Width	150	-	150	-	ns	$V_{CC} = 4.5V$ and $5.5V$, $C_L = 50pF$
TE1	Shift Clock Delay	-	125	-	80	ns	$V_{CC} = 4.5V$ and $5.5V$, $C_L = 50pF$
TE2	Serial Data Setup	75	-	50	-	ns	$V_{CC} = 4.5V$ and $5.5V$, $C_L = 50pF$
TE3	Serial Data Hold	75	-	50	-	ns	$V_{CC} = 4.5V$ and $5.5V$, $C_L = 50pF$
TE4	Enable Setup	90	-	90	-	ns	$V_{CC} = 4.5V$ and $5.5V$, $C_L = 50pF$
TE5	Enable Pulse Width	100	-	100	-	ns	$V_{CC} = 4.5V$ and $5.5V$, $C_L = 50pF$
TE6	Sync Setup	55	-	55	-	ns	$V_{CC} = 4.5V$ and $5.5V$, $C_L = 50pF$
TE7	Sync Pulse Width	150	-	150	-	ns	$V_{CC} = 4.5V$ and $5.5V$, $C_L = 50pF$
TE8	Send Data Delay	0	50	0	50	ns	$V_{CC} = 4.5V$ and $5.5V$, $C_L = 50pF$
TE9	Bipolar Output Delay	-	130	-	130	ns	$V_{CC} = 4.5V$ and $5.5V$, $C_L = 50pF$
TE10	Enable Hold	10	-	10	-	ns	$V_{CC} = 4.5V$ and $5.5V$, $C_L = 50pF$
TE11	Sync Hold	95	-	95	-	ns	$V_{CC} = 4.5V$ and $5.5V$, $C_L = 50pF$
DECODER TIMING							
FDC	Decoder Clock Frequency	-	15	-	30	MHz	$V_{CC} = 4.5V$ and $5.5V$, $C_L = 50pF$
FDS	Decoder Sync Clock	-	2.5	-	5.0	MHz	$V_{CC} = 4.5V$ and $5.5V$, $C_L = 50pF$
FDD	Decoder Data Rate	-	1.25	-	2.5	MHz	$V_{CC} = 4.5V$ and $5.5V$, $C_L = 50pF$
TDR	Decoder Reset Pulse Width	150	-	150	-	ns	$V_{CC} = 4.5V$ and $5.5V$, $C_L = 50pF$
TDRS	Decoder Reset Setup Time	75	-	75	-	ns	$V_{CC} = 4.5V$ and $5.5V$, $C_L = 50pF$
TDRH	Decoder Reset Hold Time	10	-	10	-	ns	$V_{CC} = 4.5V$ and $5.5V$, $C_L = 50pF$
TMR	Master Reset Pulse	150	-	150	-	ns	$V_{CC} = 4.5V$ and $5.5V$, $C_L = 50pF$
TD1	Bipolar Data Pulse Width	TDC + 10 (Note 1)	-	TDC + 10 (Note 1)	-	ns	$V_{CC} = 4.5V$ and $5.5V$, $C_L = 50pF$
TD3	One Zero Overlap	-	TDC - 10 (Note 1)	-	TDC - 10 (Note 1)	ns	$V_{CC} = 4.5V$ and $5.5V$, $C_L = 50pF$
TD6	Sync Delay (ON)	-20	110	-20	110	ns	$V_{CC} = 4.5V$ and $5.5V$, $C_L = 50pF$
TD7	Take Data Delay (ON)	0	110	0	110	ns	$V_{CC} = 4.5V$ and $5.5V$, $C_L = 50pF$
TD8	Serial Data Out Delay	-	80	-	80	ns	$V_{CC} = 4.5V$ and $5.5V$, $C_L = 50pF$
TD9	Sync Delay (OFF)	0	110	0	110	ns	$V_{CC} = 4.5V$ and $5.5V$, $C_L = 50pF$
TD10	Take Data Delay (OFF)	0	110	0	110	ns	$V_{CC} = 4.5V$ and $5.5V$, $C_L = 50pF$
TD11	Valid Word Delay	0	110	0	110	ns	$V_{CC} = 4.5V$ and $5.5V$, $C_L = 50pF$
TD12	Sync Clock to Shift Clock Delay	-	75	-	75	ns	$V_{CC} = 4.5V$ and $5.5V$, $C_L = 50pF$
TD13	Sync Data Setup	75	-	75	-	ns	$V_{CC} = 4.5V$ and $5.5V$, $C_L = 50pF$

NOTES:

- TDC = Decoder clock period = $1/FDC$.
- AC Testing as follows: Input levels: $V_{IH} = 70\% V_{CC}$, $V_{IL} = 20\% V_{CC}$; Input rise/fall times driven at 1 ns/V ; Timing Reference levels: $V_{CC}/2$; Output load: $C_L = 50pF$.

Timing Waveforms

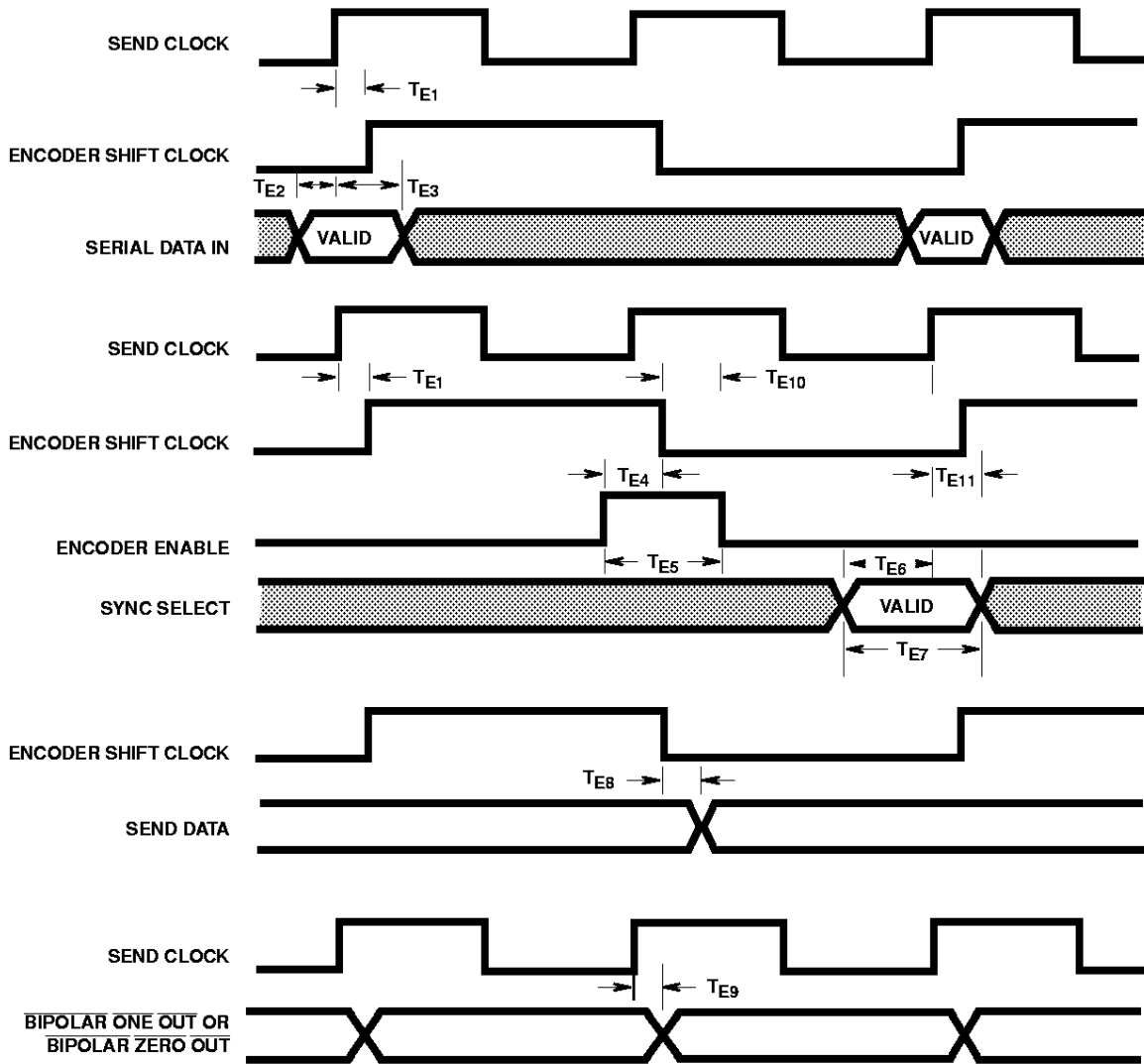
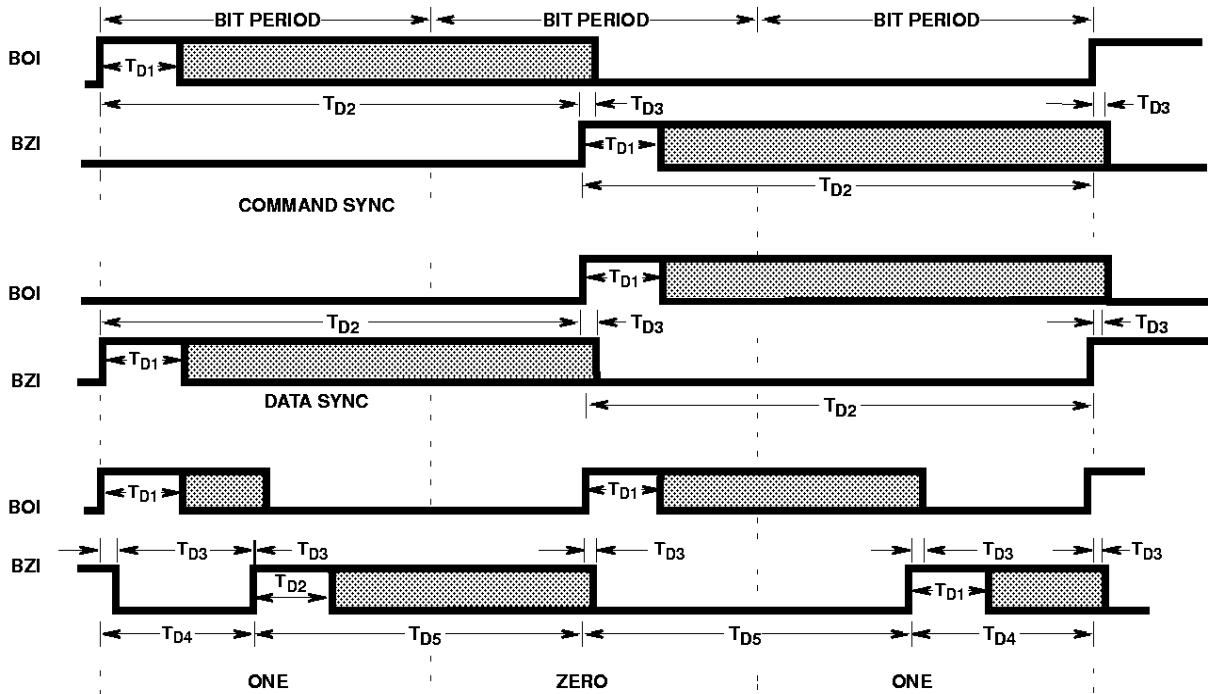

FIGURE 10. ENCODER TIMING

Timing Waveforms (Continued)

NOTE: UNIPOLAR IN = 0, FOR NEXT DIAGRAMS.



NOTE: BIPOLAR ONE IN = 0, BIPOLAR ZERO IN = 1, FOR NEXT DIAGRAMS.

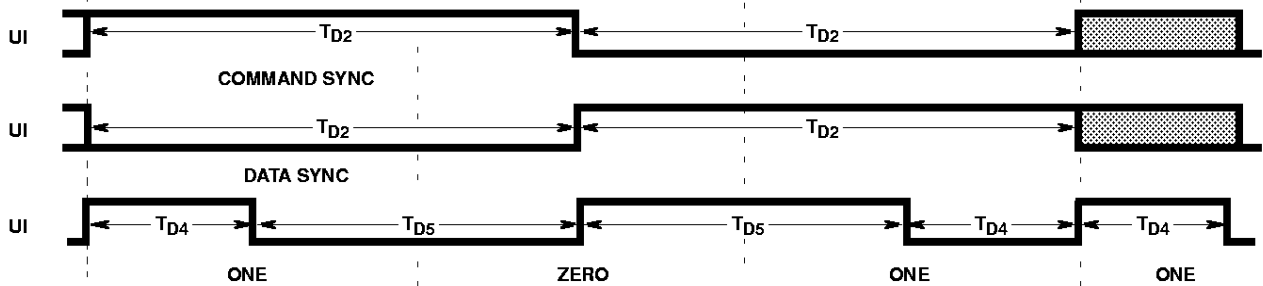

FIGURE 11. DECODER TIMING

Timing Waveforms (Continued)

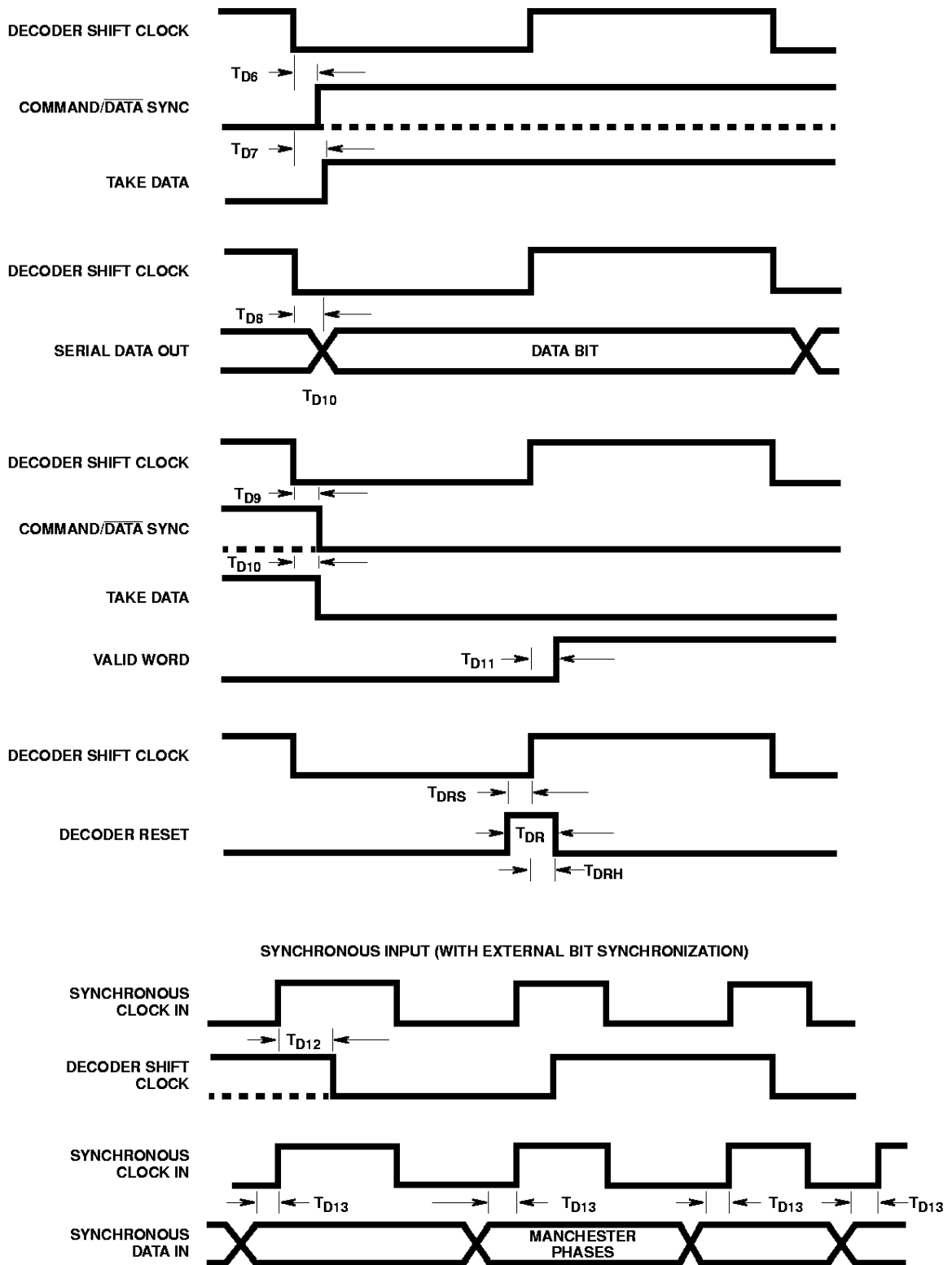

FIGURE 12. DECODER TIMINGS

Test Load Circuit

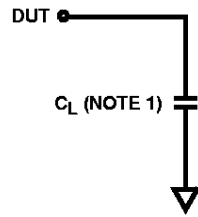

FIGURE 13.

NOTE:

1. Includes stray and jig capacitance.

AC Testing Input, Output Waveform

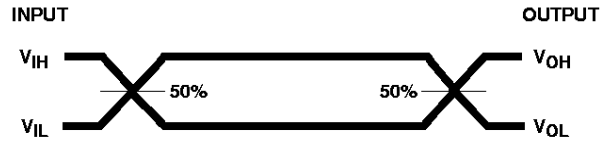

FIGURE 14.

NOTE:

1. AC Testing: All input signals must switch between V_{IL} and V_{IH} ; input rise and fall times are driven at 1 ns per volt.