

Schnitt A-A /
cross section A-A

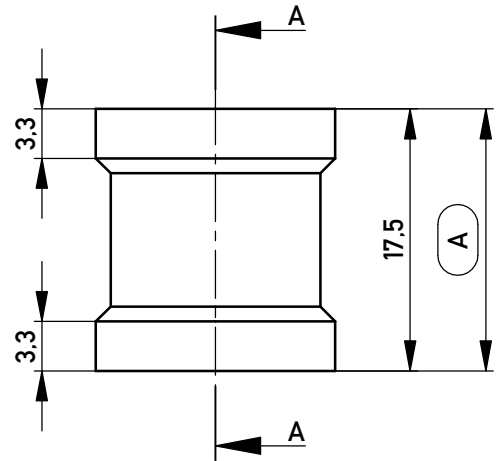

Layout - Vorschlag
PCB - Layout proposal
M 1:1
scale 1:1

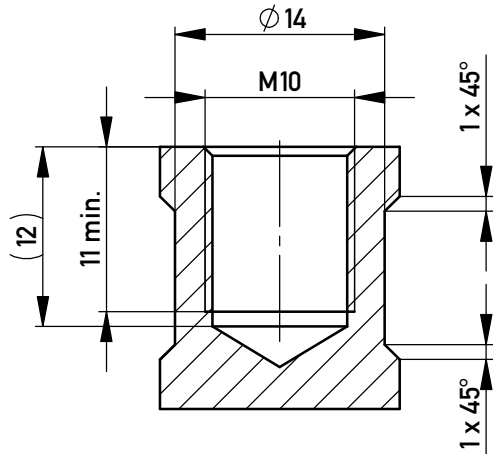

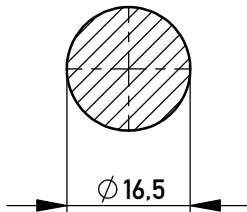

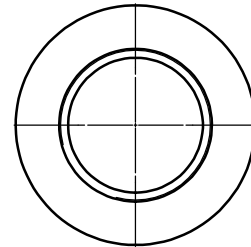
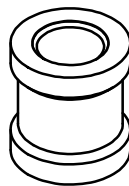
M 1:1 / scale 1:1



5-10µm Sn matt über 1-3µm Ni /
5-10µm sn matt over 1-3µm ni

Oberfläche (A) / plating (A)

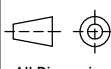
Copyright by ERNI Production GmbH & Co. KG
Proprietary notice pursuant to ISO 16016 to be observed.

Information:		Tolerances	 All Dimensions in mm	Scale: 2:1	
All rights reserved. Only for Information. To ensure that this is the latest version of this drawing, please contact one of the ERNI companies before using.		Subject to modification without prior notice. Drawing will not be updated.		Material: CuZn39Pb3	Designation
		www.ERNI.com		225861	
b	09.05.2017				
Index	Date			A4	
				Class	POWELM