

Intelligent +3.0V to +5.5V RS-232 Transceivers

FEATURES

- Meets true EIA/TIA-232-F Standards from a +3.0V to +5.5V power supply
- Interoperable with EIA/TIA-232 and adheres to EIA/TIA-562 down to a +2.7V power source
- Minimum 250Kbps data rate under load
- Regulated Charge Pump Yields Stable RS-232 Outputs Regardless of V_{CC} Variations
- Enhanced ESD Specifications:
 - +15KV Human Body Model
 - +15KV IEC1000-4-2 Air Discharge
 - +8KV IEC1000-4-2 Contact Discharge

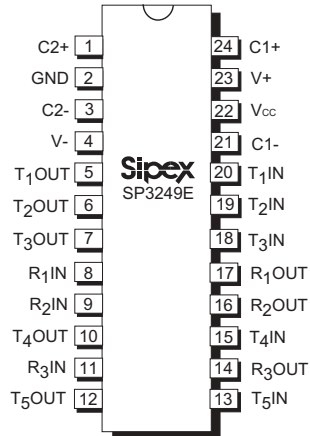

Now Available in Lead Free Packaging

DESCRIPTION

The SP3249E device is an RS-232 transceiver solution intended for portable or hand-held applications such as notebook and palmtop computers. The SP3249E uses an internal high-efficiency, charge-pump power supply that requires only 0.1 μ F capacitors in 3.3V operation. This charge pump and Sipex's driver architecture allow the SP3249E device to deliver compliant RS-232 performance from a single power supply ranging from +3.0V to +5.0V. The SP3249E is a 5-driver/3-receiver device, ideal for laptop/notebook computer and PDA applications.

SELECTION TABLE

Device	Power Supplies	RS-232 Drivers	RS-232 Receivers	External Components	AUTO ON-LINE® Circuitry	TTL 3-State	No. of Pins
SP3223E	+3.0V to +5.5V	2	2	4 capacitors	YES	YES	20
SP3243E	+3.0V to +5.5V	3	5	4 capacitors	YES	YES	28
SP3238E	+3.0V to +5.5V	5	3	4 capacitors	YES	YES	28
SP3239E	+3.0V to +5.5V	5	3	4 capacitors	NO	YES	28
SP3249E	+3.0V to +5.5V	5	3	4 capacitors	NO	NO	24

Applicable U.S. Patents - 5,306,954; and other patents pending.

ABSOLUTE MAXIMUM RATINGS

These are stress ratings only and functional operation of the device at these ratings or any other above those indicated in the operation sections of the specifications below is not implied. Exposure to absolute maximum rating conditions for extended periods of time may affect reliability and cause permanent damage to the device.

V_{CC}	-0.3V to +6.0V
$V+$ (NOTE 1)	-0.3V to +7.0V
$V-$ (NOTE 1)	+0.3V to -7.0V
$V+ + V- $ (NOTE 1)	+13V
I_{CC} (DC V_{CC} or GND current)	± 100 mA

Input Voltages

TxIN	-0.3V to +6.0V
RxIN	± 25 V

Output Voltages

TxOUT	± 13.2 V
RxOUT	-0.3V to ($V_{CC} + 0.3$ V)

Short-Circuit Duration

TxOUT	Continuous
Storage Temperature	-65°C to +150°C

Note 1: $V+$ and $V-$ can have maximum magnitudes of 7V, but their absolute difference cannot exceed 13V.

ELECTRICAL CHARACTERISTICS

$V_{CC} = +3.0$ to $+5.5$, C1 -C4 = 0.1 μ F (tested at 3.3V \pm 5%), C1-C4 = 0.22 μ F (tested at 3.3V \pm 10%), C1 = 0.047 μ F, and C2-C4 = 0.33 μ F (tested at 5.0V \pm 10%), $T_A = T_{MIN}$ to T_{MAX} unless otherwise noted. Typical values are at $T_A = +25^\circ$ C.)

PARAMETER	MIN.	TYP.	MAX.	UNITS	CONDITIONS
Supply Current		0.3	1.0	mA	V_{CC} , no load
LOGIC INPUTS AND RECEIVER OUTPUTS					
Input Logic Threshold LOW HIGH	2.4		0.8	V	$V_{CC} = +3.3$ V or $+5.0$ V, TxIN
Input Leakage Current		± 0.01	± 1.0	μ A	TxIN, $T_A = 25^\circ$ C
Output Voltage LOW			0.4	V	$I_{OUT} = 1.6$ mA
Output Voltage HIGH	$V_{CC} - 0.6$	$V_{CC} - 0.1$		V	$I_{OUT} = -1.0$ mA
DRIVER OUTPUTS					
Output Voltage Swing	± 5.0	± 5.4		V	All driver outputs loaded with 3K Ω to GND
Output Resistance	300			Ω	$V_{CC} = V+ = V- = 0$ V, $V_{OUT} = \pm 2$ V
Output Short-Circuit Current		± 35	± 60	mA	$V_{OUT} =$ GND
RECEIVER INPUTS					
Input Voltage Range	-25		25	V	
Input Threshold LOW	0.6	1.2		V	$V_{CC} = 3.3$ V
Input Threshold LOW	0.8	1.5		V	$V_{CC} = 5.0$ V
Input Threshold HIGH		1.5	2.4	V	$V_{CC} = 3.3$ V
Input Threshold HIGH		1.8	2.4	V	$V_{CC} = 5.0$ V
Input Hysteresis		0.5		V	
Input Resistance	3	5	7	k Ω	

ELECTRICAL CHARACTERISTICS

$V_{CC} = +3.0$ to $+5.5$, $C1-C4 = 0.1\mu\text{F}$ (tested at $3.3\text{V} \pm 5\%$), $C1-C4 = 0.22\mu\text{F}$ (tested at $3.3\text{V} \pm 10\%$), $C1 = 0.047\mu\text{F}$, and $C2-C4 = 0.33\mu\text{F}$ (tested at $5.0\text{V} \pm 10\%$), $T_A = T_{MIN}$ to T_{MAX} , unless otherwise noted. Typical values are at $T_A = +25^\circ\text{C}$.)

PARAMETER	MIN.	TYP.	MAX.	UNITS	CONDITIONS
TIMING CHARACTERISTICS					
Maximum Data Rate	250			kbps	$R_L = 3\text{k}\Omega$, $C_L = 1000\text{pF}$, one driver switching
Receiver Propagation Delay t_{PHL} t_{PLH}		0.15 0.15		μS	Receiver input to receiver output, $C_L = 150\text{pF}$
Receiver Output Enable Time		200		ns	Normal operation
Receiver Output Disable Time		200		ns	Normal operation
Driver Skew		100		ns	$ t_{PLH} - t_{PHL} $, $T_A = 25^\circ\text{C}$
Receiver Skew		50		ns	$ t_{PLH} - t_{PHL} $
Transition-Region Slew Rate			30	$\text{V}/\mu\text{s}$	$V_{CC} = 3.3\text{V}$, $R_L = 3\text{k}\Omega$, $T_{AMB} = 25^\circ\text{C}$, measurements taken from -3.0V to $+3.0\text{V}$ or $+3.0\text{V}$ to -3.0V

TYPICAL PERFORMANCE CHARACTERISTICS

Unless otherwise noted, the following performance characteristics apply for $V_{CC} = +3.3\text{V}$, 250kbps data rate, all drivers loaded with $3\text{k}\Omega$, $0.1\mu\text{F}$ charge pump capacitors, and $T_{AMB} = +25^\circ\text{C}$.

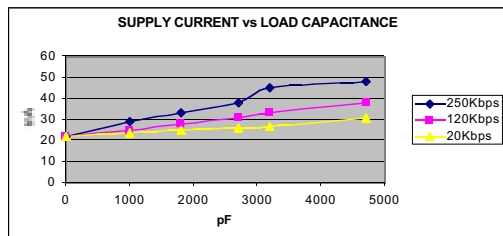
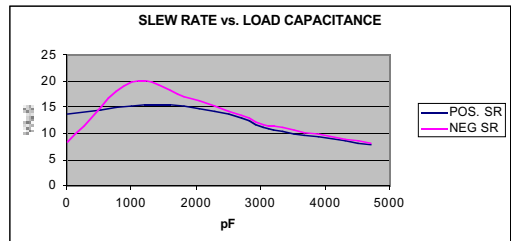
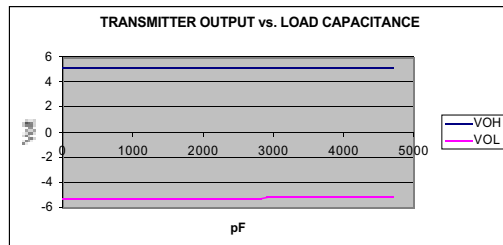

Figure 3. Supply Current VS. Load Capacitance when Transmitting Data

PIN DESCRIPTION

NAME	FUNCTION	PIN NO.
C2+	Positive terminal of the symmetrical charge-pump capacitor C2.	1
GND	Ground.	2
C2-	Negative terminal of the symmetrical charge-pump capacitor C2.	3
V-	Regulated -5.5V output generated by the charge pump.	4
T ₁ OUT	RS-232 driver output.	5
T ₂ OUT	RS-232 driver output.	6
T ₃ OUT	RS-232 driver output.	7
R ₁ IN	RS-232 receiver input.	8
R ₂ IN	RS-232 receiver input.	9
T ₄ OUT	RS-232 driver output.	10
R ₃ IN	RS-232 receiver input.	11
T ₅ OUT	RS-232 driver output.	12
T₅IN	TTL/CMOS driver input.	13
<u>R₃OUT</u>	TTL/CMOS receiver output.	14
T ₄ IN	TTL/CMOS driver input.	15
<u>R₂OUT</u>	TTL/CMOS receiver output.	16
R ₁ OUT	TTL/CMOS receiver output.	17
T ₃ IN	TTL/CMOS driver input.	18
T ₂ IN	TTL/CMOS driver input.	19
T ₁ IN	TTL/CMOS driver input.	20
C1-	Negative terminal of the symmetrical charge-pump capacitor C1.	21
V _{CC}	+3.0V to +5.5V supply voltage.	22
V+	Regulated +5.5V output generated by the charge pump.	23
C1+	Positive terminal of the voltage doubler charge-pump capacitor C1	24

Table 1. Device Pin Description

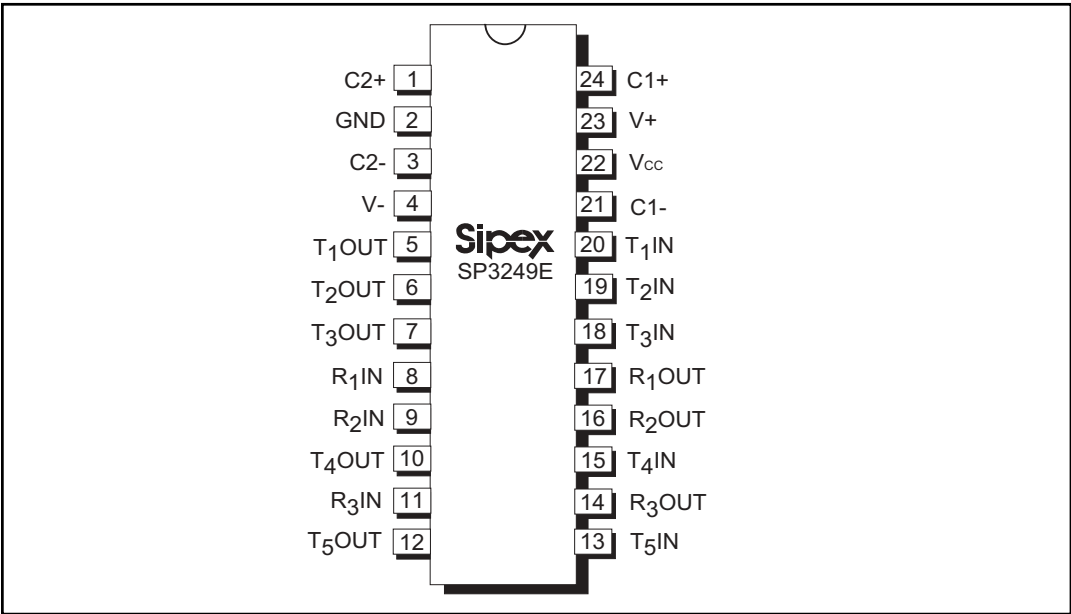

Figure 4. SP3249E Pinout Configuration

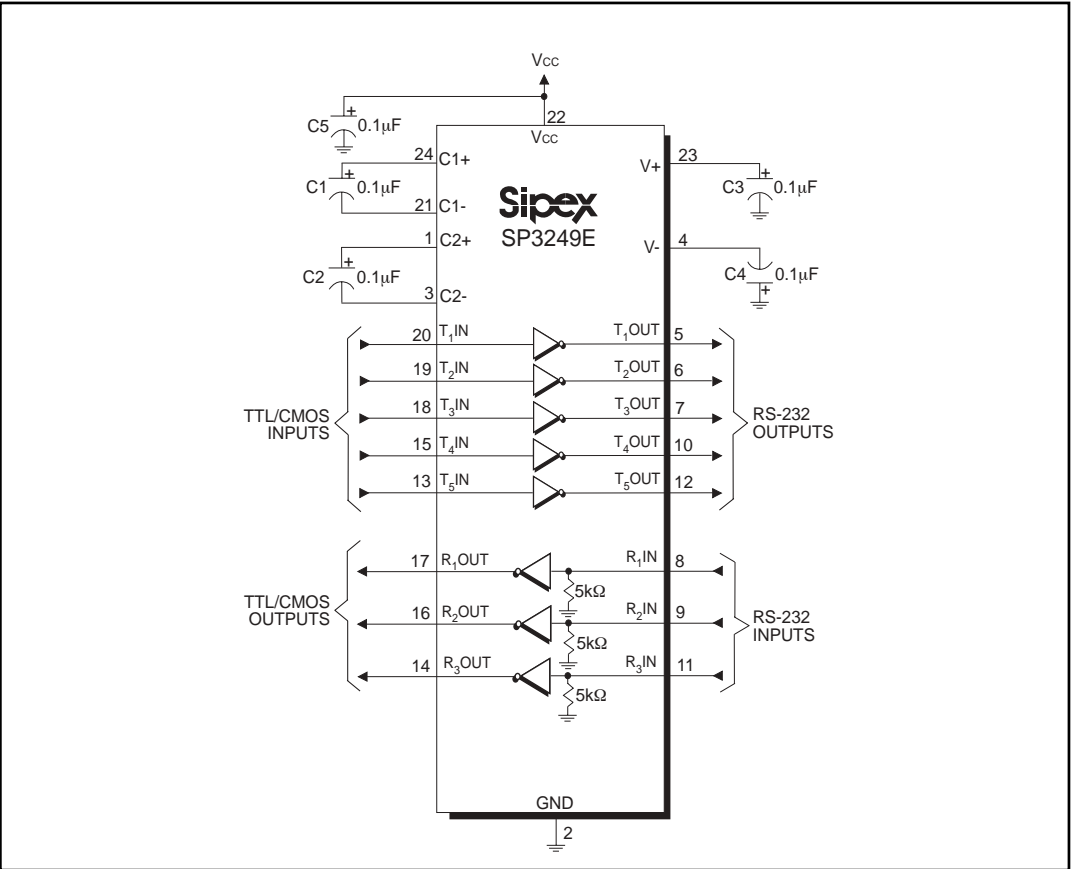

Figure 5. SP3249E Typical Operating Circuit

DESCRIPTION

The SP3249E device meets the EIA/TIA-232 and ITU-T V.28/V.24 communication protocols and can be implemented in battery-powered, portable, or hand-held applications such as notebook or palmtop computers. The SP3249E device features Sipex's proprietary and patented (U.S. #5,306,954) on-board charge pump circuitry that generates $\pm 5.5V$ RS-232 voltage levels from a single +3.0V to +5.5V power supply. The SP3249E device can operate at a data rate of 250kbps fully loaded.

The SP3249E is a 5-driver/3-receiver device, ideal for portable or hand-held applications.

The SP3249E device is an ideal choice for power sensitive designs.

THEORY OF OPERATION

The SP3249E device is made up of four basic circuit blocks: 1. Drivers, 2. Receivers, 3. the Sipex proprietary charge pump, and

Drivers

The drivers are inverting level transmitters that convert TTL or CMOS logic levels to 5.0V EIA/TIA-232 levels with an inverted sense relative to the input logic levels. Typically, the RS-232 output voltage swing is $\pm 5.4V$ with no load and $\pm 5V$ minimum fully loaded. The driver outputs are protected against infinite short-circuits to ground without degradation in reliability. These drivers comply with the EIA-TIA-232F and all previous RS-232 versions. All unused driver inputs must be connected to V_{CC} or GND.

The drivers can guarantee a data rate of 250kbps fully loaded with $3k\Omega$ in parallel with $1000pF$, ensuring compatibility with PC-to-PC communication software.

The slew rate of the driver output is internally limited to a maximum of $30V/\mu s$ in order to meet the EIA standards (EIA RS-232D 2.1.7, Paragraph 5). The transition of the loaded output from HIGH to LOW also meets the monotonicity requirements of the standard.

Figure 7 shows a loopback test circuit used to test the RS-232 Drivers. Figure 8 shows the test results of the loopback circuit with all five drivers active at 120kbps with typical RS-232 loads in parallel with $1000pF$ capacitors. Figure 6 shows the test results where one driver was active at 250kbps and all five drivers loaded with an RS-232 receiver in parallel with a $1000pF$ capacitor. A solid RS-232 data transmission rate of 120kbps provides compatibility with many designs in personal computer peripherals and LAN applications.

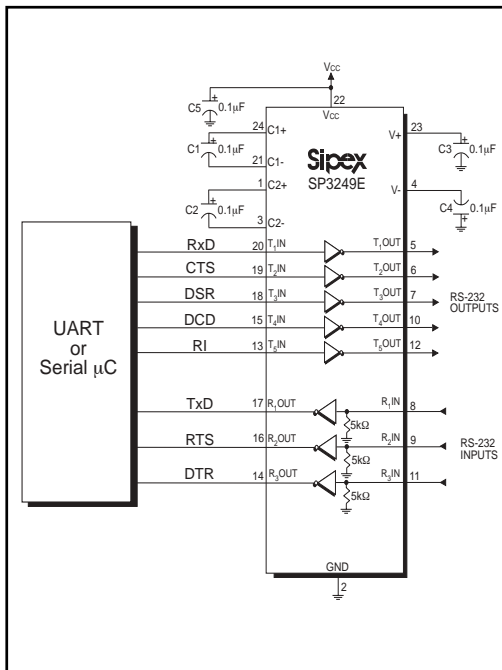

Figure 6. Interface Circuitry Controlled by Microprocessor Supervisory Circuit

Receivers

The receivers convert $\pm 5.0\text{V}$ EIA/TIA-232 levels to TTL or CMOS logic output levels.

Since receiver input is usually from a transmission line where long cable lengths and system interference can degrade the signal, the inputs have a typical hysteresis margin of 500mV. This ensures that the receiver is virtually immune to noisy transmission lines. Should an input be left unconnected, an internal $5\text{k}\Omega$ pulldown resistor to ground will commit the output of the receiver to a HIGH state.

Charge Pump

The charge pump is a Sipex-patented design (U.S. #5,306,954) and uses a unique approach compared to older less-efficient designs. The charge pump still requires four external capacitors, but uses a four-phase voltage shifting technique to attain symmetrical 5.5V power supplies. The internal power supply consists of a regulated dual charge pump that provides output voltages 5.5V regardless of the input voltage (V_{CC}) over the +3.0V to +5.5V range. This is important to maintain compliant RS-232 levels regardless of power supply fluctuations.

The charge pump operates in a discontinuous mode using an internal oscillator. If the output voltages are less than a magnitude of 5.5V, the

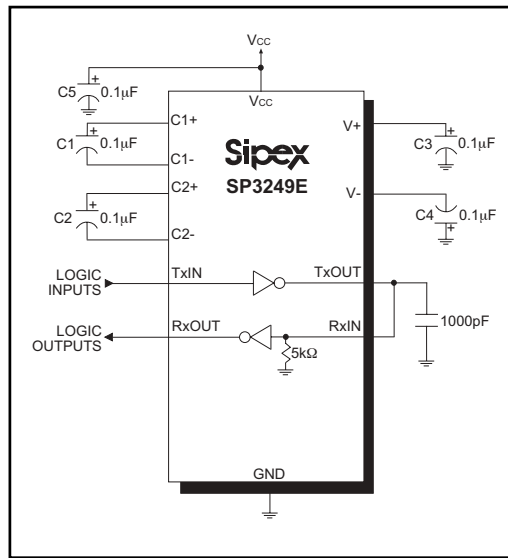

Figure 7. Loopback Test Circuit for RS-232 Driver Data Transmission Rates

charge pump is enabled. If the output voltages exceed a magnitude of 5.5V, the charge pump is disabled. This oscillator controls the four phases of the voltage shifting (Figure 13). A description of each phase follows.

Phase 1 (Figure 11)

— V_{SS} charge storage — During this phase of the clock cycle, the positive side of capacitors C_1 and C_2 are initially charged to V_{CC} . C_{1+} is then switched to GND and the charge in C_{1-} is transferred to C_{2-} . Since C_{2+} is connected to V_{CC} , the voltage potential across capacitor C_2 is now 2 times V_{CC} .

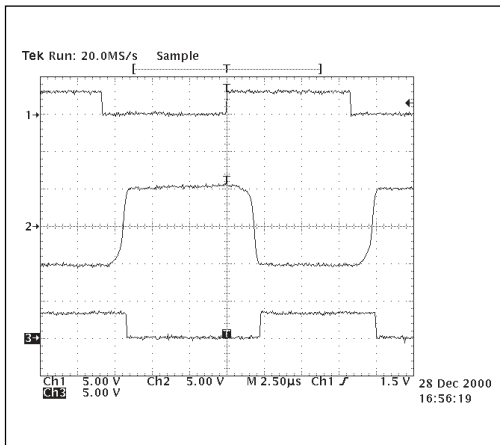

Figure 8. Loopback Test Circuit Result at 120kbps (All Drivers Fully Loaded)

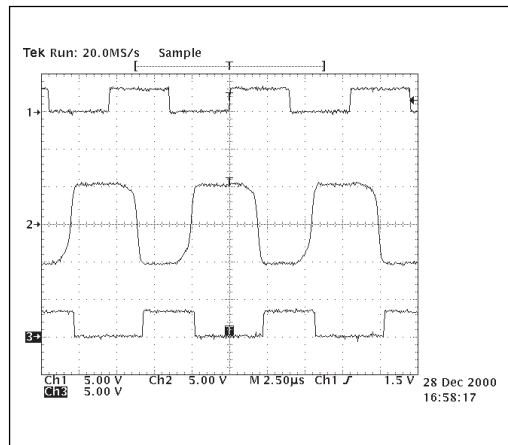

Figure 9. Loopback Test Circuit result at 250kbps (All Drivers Fully Loaded)

Phase 2 (Figure 12)

— V_{SS} transfer — Phase two of the clock connects the negative terminal of C_2 to the V_{SS} storage capacitor and the positive terminal of C_2 to GND. This transfers a negative generated voltage to C_3 . This generated voltage is regulated to a minimum voltage of $-5.5V$. Simultaneous with the transfer of the voltage to C_3 , the positive side of capacitor C_1 is switched to V_{CC} and the negative side is connected to GND.

Phase 3 (Figure 14)

— V_{DD} charge storage — The third phase of the clock is identical to the first phase — the charge transferred in C_1 produces $-V_{CC}$ in the negative terminal of C_1 , which is applied to the negative side of capacitor C_2 . Since C_2^+ is at V_{CC} , the voltage potential across C_2 is 2 times V_{CC} .

Phase 4 (Figure 15)

— V_{DD} transfer — The fourth phase of the clock connects the negative terminal of C_2 to GND, and transfers this positive generated voltage across C_2 to C_4 , the V_{DD} storage capacitor. This voltage is regulated to $+5.5V$. At this voltage, the internal oscillator is disabled. Simultaneous with the transfer of the voltage to C_4 , the positive side of capacitor C_1 is switched to V_{CC} and the negative side is connected to GND, allowing the charge pump cycle to begin again. The charge pump cycle will continue as long as the operational conditions for the internal oscillator are present.

Since both V^+ and V^- are separately generated from V_{CC} , in a no-load condition V^+ and V^- will be symmetrical. Older charge pump approaches that generate V^- from V^+ will show a decrease in the magnitude of V^- compared to V^+ due to the inherent inefficiencies in the design.

The clock rate for the charge pump typically operates at 500kHz. The external capacitors can be as low as $0.1\mu F$ with a 16V breakdown voltage rating.

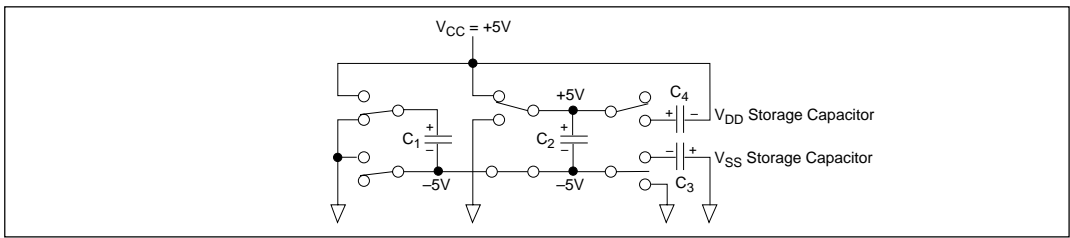

Figure 10. Charge Pump — Phase 1

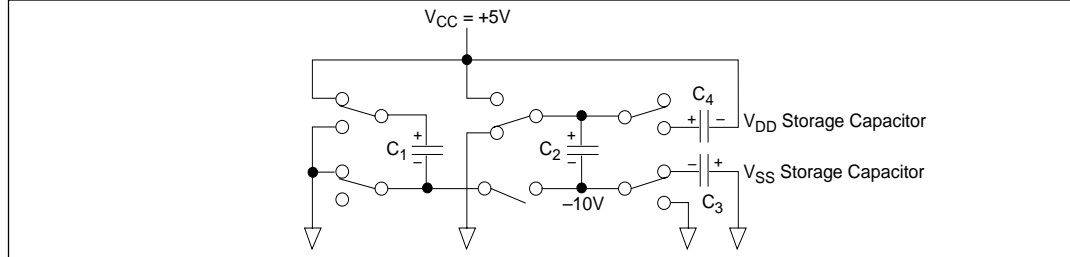

Figure 11. Charge Pump — Phase 2

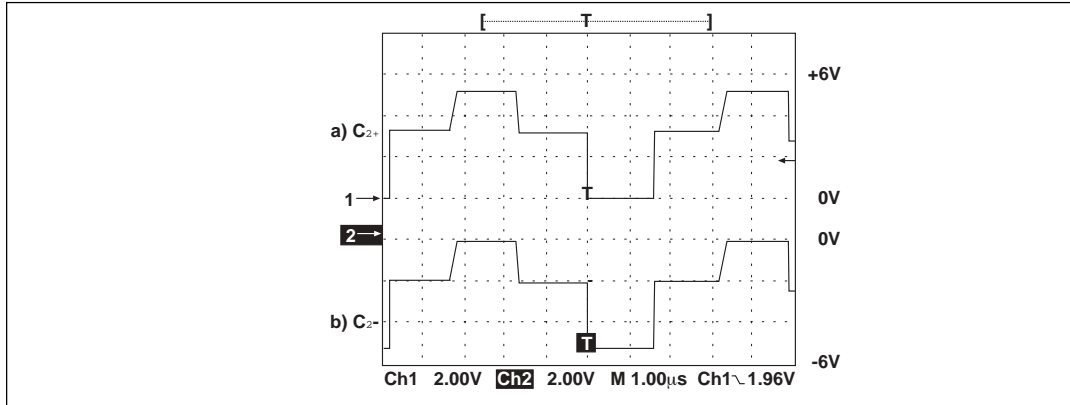

Figure 12. Charge Pump Waveforms

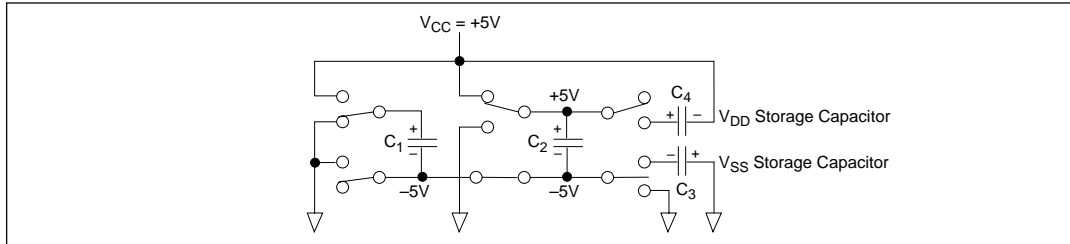

Figure 13. Charge Pump — Phase 3

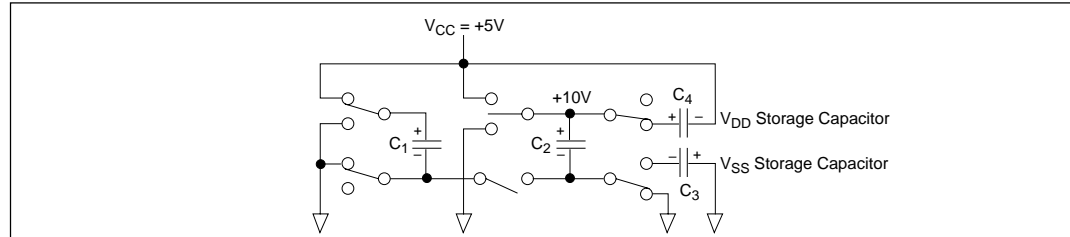

Figure 14. Charge Pump — Phase 4

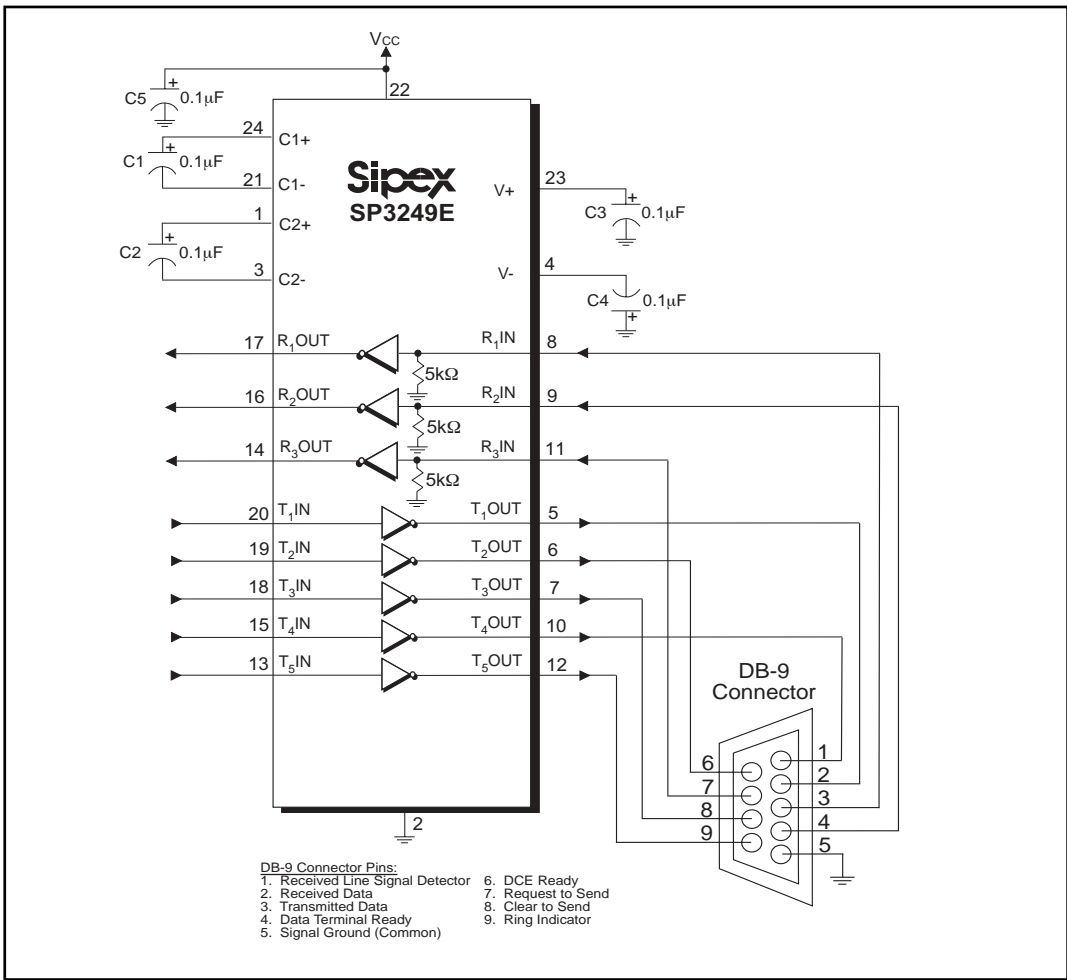

Figure 15. Circuit for the connectivity of the SP3249E with a DB-9 connector

ESD TOLERANCE

The SP3249E device incorporates ruggedized ESD cells on all driver output and receiver input pins. The ESD structure is improved over our previous family for more rugged applications and environments sensitive to electro-static discharges and associated transients. The improved ESD tolerance is at least $\pm 15\text{kV}$ without damage nor latch-up.

There are different methods of ESD testing applied:

- a) MIL-STD-883, Method 3015.7
- b) IEC1000-4-2 Air-Discharge
- c) IEC1000-4-2 Direct Contact

The Human Body Model has been the generally accepted ESD testing method for semiconductors. This method is also specified in MIL-STD-883, Method 3015.7 for ESD testing. The premise of this ESD test is to simulate the human body's potential to store electro-static energy and discharge it to an integrated circuit. The simulation is performed by using a test model as shown in Figure 16. This method will test the IC's capability to withstand an ESD transient during normal handling such as in manufacturing areas where the ICs tend to be handled frequently.

The IEC-1000-4-2, formerly IEC801-2, is generally used for testing ESD on equipment and systems. For system manufacturers, they must guarantee a certain amount of ESD protection since the system itself is exposed to the outside environment and human presence. The premise with IEC1000-4-2 is that the system is required to withstand an amount of static electricity when ESD is applied to points and surfaces of the equipment that are accessible to personnel during

normal usage. The transceiver IC receives most of the ESD current when the ESD source is applied to the connector pins. The test circuit for IEC1000-4-2 is shown on Figure 20. There are two methods within IEC1000-4-2, the Air Discharge method and the Contact Discharge method.

With the Air Discharge Method, an ESD voltage is applied to the equipment under test (EUT) through air. This simulates an electrically charged person ready to connect a cable onto the rear of the system only to find an unpleasant zap just before the person touches the back panel. The high energy potential on the person discharges through an arcing path to the rear panel of the system before he or she even touches the system. This energy, whether discharged directly or through air, is predominantly a function of the discharge current rather than the discharge voltage. Variables with an air discharge such as approach speed of the object carrying the ESD potential to the system and humidity will tend to change the discharge current. For example, the rise time of the discharge current varies with the approach speed.

The Contact Discharge Method applies the ESD current directly to the EUT. This method was devised to reduce the unpredictability of the ESD arc. The discharge current rise time is constant since the energy is directly transferred without the air-gap arc. In situations such as hand held systems, the ESD charge can be directly discharged to the equipment from a person already holding the equipment. The current is transferred on to the keypad or the serial port of the equipment directly and then travels through the PCB and finally to the IC.

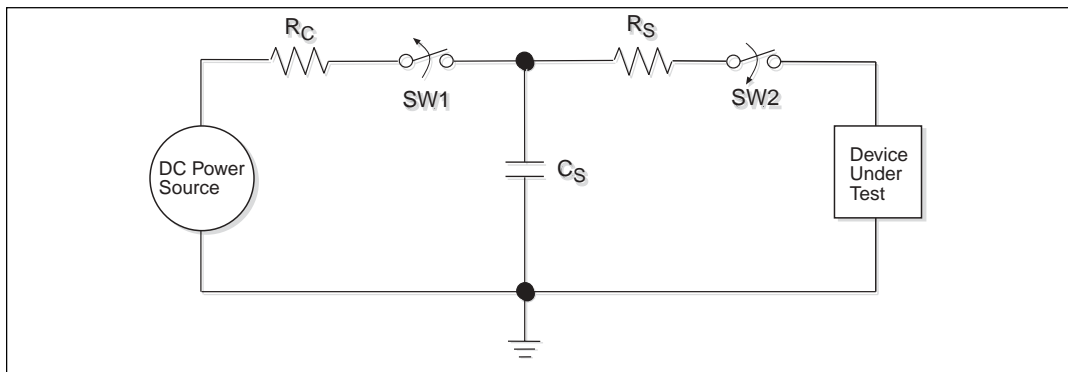

Figure 16. ESD Test Circuit for Human Body Model

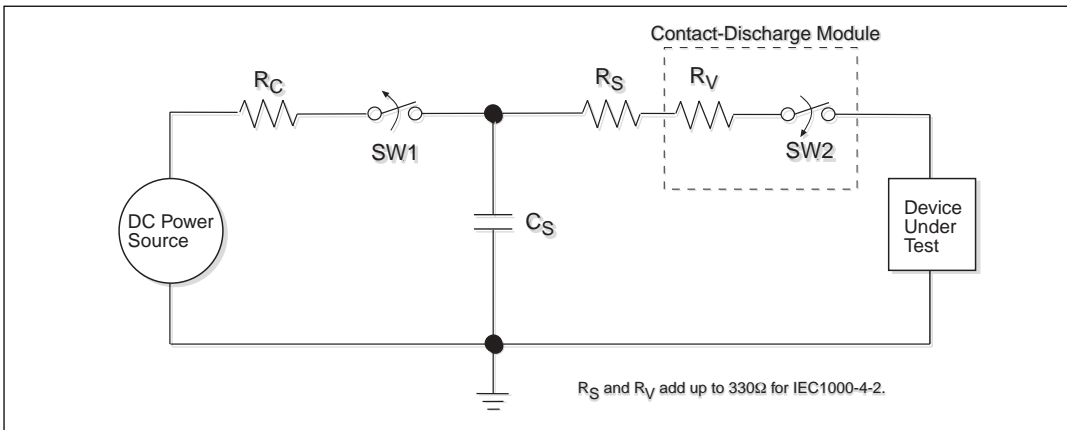

Figure 17. ESD Test Circuit for IEC1000-4-2

The circuit model in Figures 16 and 17 represent the typical ESD testing circuit used for all three methods. The C_S is initially charged with the DC power supply when the first switch (SW1) is on. Now that the capacitor is charged, the second switch (SW2) is on while SW1 switches off. The voltage stored in the capacitor is then applied through R_S , the current limiting resistor, onto the device under test (DUT). In ESD tests, the SW2 switch is pulsed so that the device under test receives a duration of voltage.

For the Human Body Model, the current limiting resistor (R_S) and the source capacitor (C_S) are $1.5k\Omega$ and $100pF$, respectively. For IEC-1000-4-2, the current limiting resistor (R_S) and the source capacitor (C_S) are 330Ω and $150pF$, respectively.

The higher C_S value and lower R_S value in the IEC1000-4-2 model are more stringent than the Human Body Model. The larger storage capacitor injects a higher voltage to the test point when SW2 is switched on. The lower current limiting resistor increases the current charge onto the test

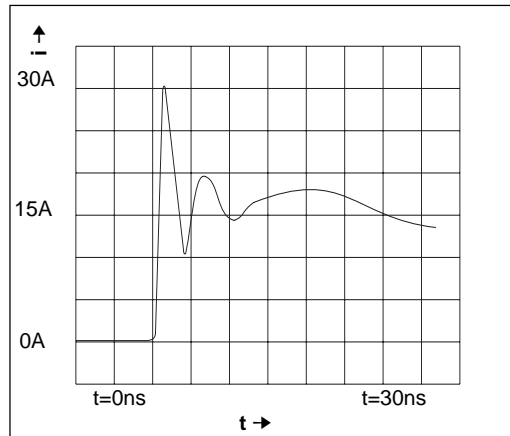
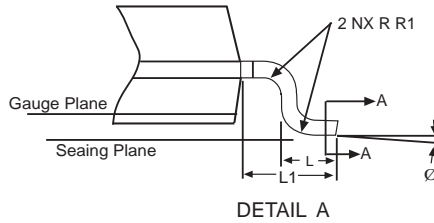
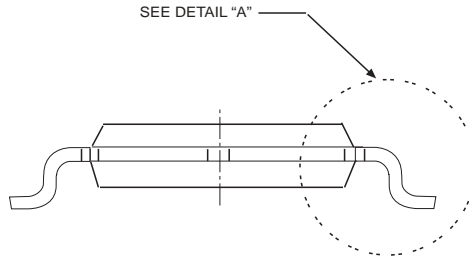
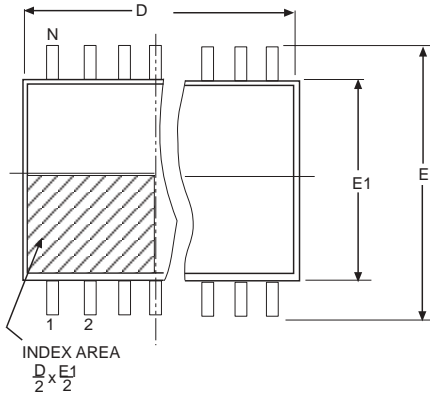

Figure 18. ESD Test Waveform for IEC1000-4-2

DEVICE PIN TESTED	HUMAN BODY MODEL	IEC1000-4-2		
		Air Discharge	Direct Contact	Level
Driver Outputs	$\pm 15kV$	$\pm 15kV$	$\pm 8kV$	4
Receiver Inputs	$\pm 15kV$	$\pm 15kV$	$\pm 8kV$	4

Table 2. Transceiver ESD Tolerance Levels



24 Pin SSOP JEDEC MO-153 (AD) Variation			
SYMBOL	MIN	NOM	MAX
A	-	-	2
A1	0.05	-	-
A2	1.65	1.75	1.85
b	0.22	-	0.38
c	0.09	-	0.25
D	6.9	7.2	7.5
E	7.4	7.8	8.2
E1	5	5.3	5.6
L	0.55	0.75	0.95
L1	1.25 REF		
ø	0°	4°	8°

Note: Dimensions in (mm)

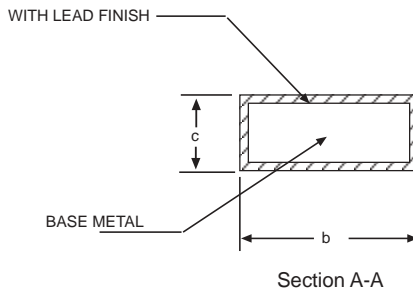
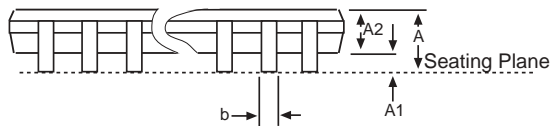

24 PIN SSOP

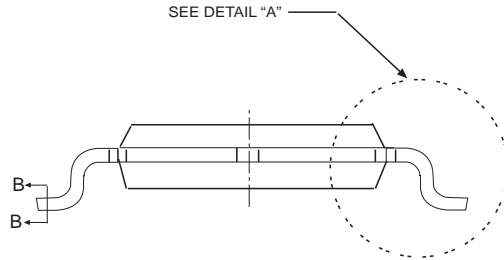
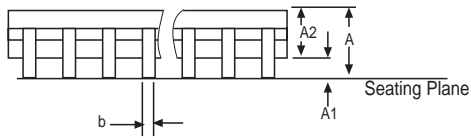
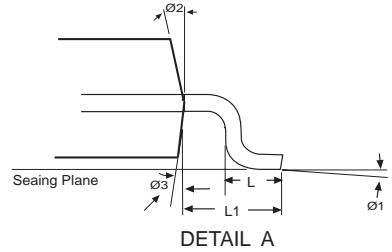
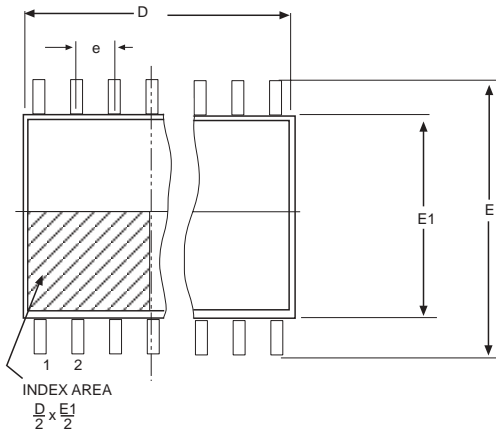

24 Pin TSSOP JEDEC MO-153 (AD) Variation			
SYMBOL	MIN	NOM	MAX
A	-	-	1.2
A1	0.05	-	0.15
A2	0.8	1	1.05
b	0.19	-	0.3
c	0.09	-	0.2
D	7.7	7.8	7.9
e	0.65 BSC		
E	6.40 BSC		
E1	4.3	4.4	4.5
L	0.8	1	1.05
L1	1.00 REF		
Ø1	0°	4°	8°

Note: Dimensions in (mm)

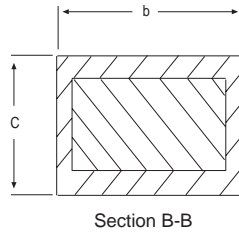

ORDERING INFORMATION

Model	Temperature Range	Package Types
SP3249ECA	0°C to +70°C	24-pin SSOP
SP3249ECA/TR	0°C to +70°C	24-pin SSOP
SP3249ECY	0°C to +70°C	24-pin TSSOP
SP3249ECY/TR	0°C to +70°C	24-pin TSSOP
SP3249EEA	-40°C to +85°C	24-pin SSOP
SP3249EEA/TR	-40°C to +85°C	24-pin SSOP
SP3249EEY	-40°C to +85°C	24-pin TSSOP
SP3249EEY/TR	-40°C to +85°C	24-pin TSSOP

Available in lead free packaging. To order add "-L" suffix to part number.

Example: SP3249EEY/TR = standard; SP3249EEY-L/TR = lead free

/TR = Tape and Reel

Pack quantity is 1,500 for SSOP or TSSOP.

 [CLICK HERE TO ORDER SAMPLES](#) 



ANALOG EXCELLENCE

Sipex Corporation

Headquarters and
Sales Office

233 South Hillview Drive
Milpitas, CA 95035
TEL: (408) 934-7500
FAX: (408) 935-7600

Sipex Corporation reserves the right to make changes to any products described herein. Sipex does not assume any liability arising out of the application or use of any product or circuit described herein; neither does it convey any license under its patent rights nor the rights of others.