

SMT Common Mode Chokes

PH9407.XXXNLT and PH9408.XXXNLT Series

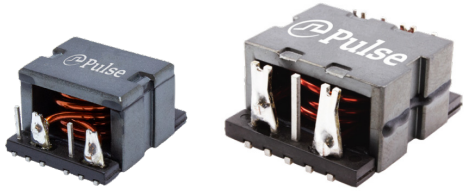

- Ⓜ ER19 and ER25 Planar Platforms
- Ⓜ 24.9x21.6x16.9mm and 30.5x27x18mm Max
- Ⓜ Up to 39Arms rated current
- Ⓜ Up to 1500Vrms Isolation⁴ (380Vrms continuous)

Electrical Specifications @ 25°C - Operating Temperature -40°C to +125°C

Part Number	Inductance (2,3-5,6)	I _{rated}	LK (2,3-5,6) with (7,8,10,11) shorted	Capacitance N1 to N2 (2,3,5,6) to (7,8,10,11)	DCR (2,3-5,6)=(10,11-7,8)	Self Resonant Frequency (2,3-5,6)=(10,11-7,8)	Impedance at SRF
	($\mu\text{H} \pm 35\%$)	(A)	($\mu\text{H TYP}$)	(pF TYP)	(m Ω MAX)	(MHz TYP)	(k Ω TYP)
PH9407.XXXNLT - 24.9mm x 21.6mm x 16.9mm Max							
PH9407.104NLT	120.0	20	0.4	4.3	2.50	1.65	0.73
PH9407.204NLT	200.0	17	0.5	6.4	3.50	1.79	1.08
PH9407.304NLT	280.0	14	0.9	7.0	4.80	1.57	1.60
PH9407.404NLT	360.0	12	1.3	7.2	5.30	1.56	1.72
PH9407.504NLT	480.0	10	1.5	7.8	7.80	1.42	2.35
PH9408.XXXNLT - 30.5mm x 27mm x 18mm Max							
PH9408.164NLT	160.0*	39	1.5	8	1.3	1.6	0.4
PH9408.254NLT	250.0*	32	2.0	8	1.7	2.0	0.6
PH9408.364NLT	360.0	23	3.0	9	3.5	1.2	1.5
PH9408.494NLT	490.0	21	4.0	10	4.0	1.1	2.0
PH9408.644NLT	640.0	19	6.0	11	5.6	1.1	2.5
PH9408.814NLT	810.0	18	6.0	11	6.3	1.1	3.4
PH9408.105NLT	1000	17	6.0	11	7.0	1.1	4.3
PH9408.155NLT	1450	12	6.0	11	13	0.95	5.5

* Inductance tolerance on indicated part numbers is -35% min; tolerance is $\pm 35\%$ on all other parts.

NOTE:

1. The I_{rated} is based upon the temperature rise of the component and represents the rms current which will cause a typical temperature rise of 50°C with free air cooling.
2. The temperature of the component (ambient plus temperature rise) must be within the stated operating temperature range.
3. Pulse complies to industry standard tape and reel specification EIA481.
4. 1500Vrms for PH9408.XXXNLT, 1000Vrms for PH9407.XXXNLT

SMT Common Mode Chokes

PH9407.XXXNLT and PH9408.XXXNLT Series

Mechanicals

Schematic

PH9407.XXXNLT

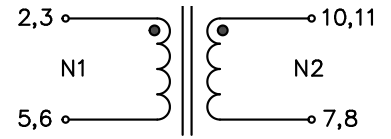
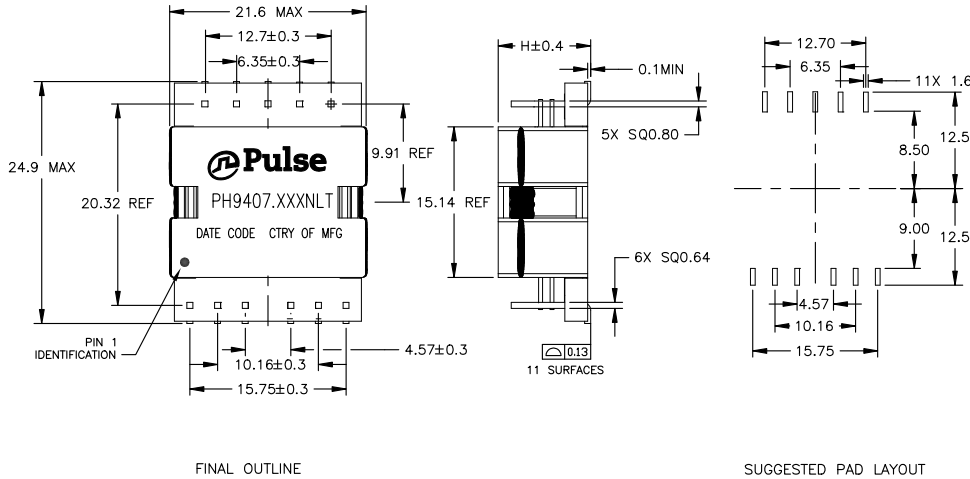

PH9407. Series	H(mm Max)	Weight(g TYP)	Tape & Reel
104NLT	13.5	17.0	100/ Reel
204NLT	14.4	17.7	100/ Reel
304NLT	15.6	18.5	80/ Reel
404NLT	16.5	19.3	80/ Reel
504NLT	16.5	19.3	80/ Reel

Dimensions: mm
Unless otherwise specified, all tolerance are ±0.25

Mechanicals

Schematic

PH9408.XXXNLT

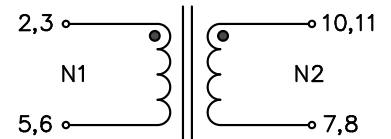
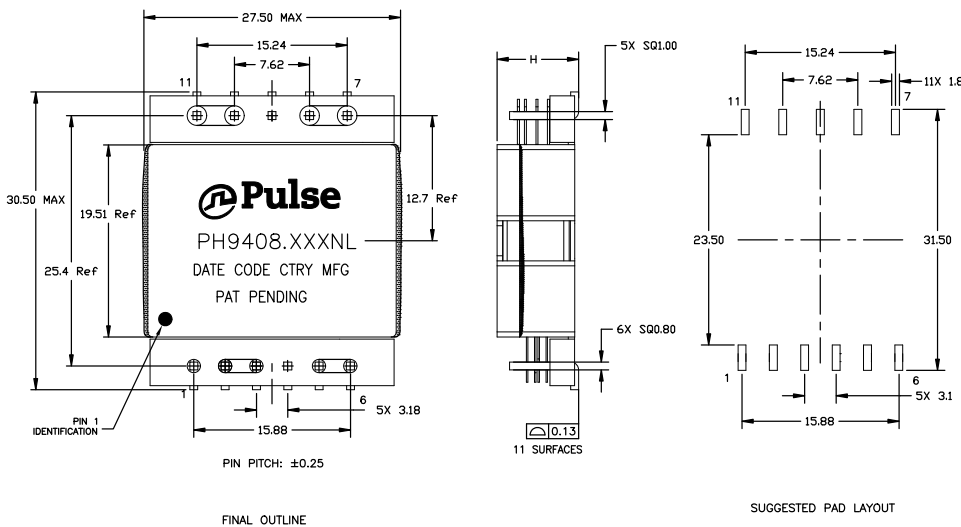

PH9408. Series	H(mm Max)	Weight(g TYP)	Tape & Reel
164NLT	15.0	25.5	60/ Reel
254NLT	15.0	27.0	60/ Reel
364NLT	17.0	29.5	45/ Reel
494NLT	17.0	31.0	45/ Reel
644NLT	18.0	31.5	45/ Reel
814NLT	18.0	32.5	45/ Reel
105NLT	18.0	33.5	45/ Reel
155NLT	18.0	32.5	45/ Reel

Dimensions: mm
Unless otherwise specified, all tolerance are ±0.25

SMT Common Mode Chokes

PH9407.XXXNLT and PH9408.XXXNLT Series

Impedance Plots

PH9407.XXXNLT

PH9407.XXXNLT

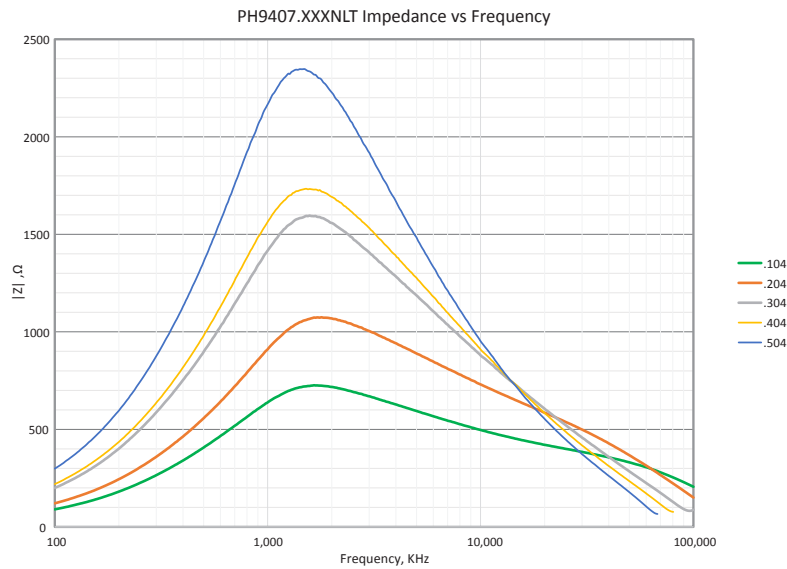

PH9408.XXXNLT

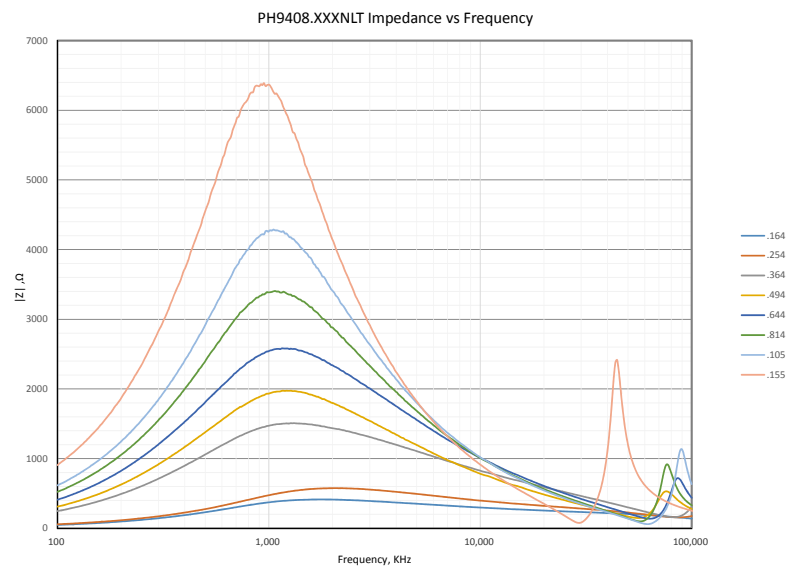

For More Information:

Americas - proinfo_power_americas@yageo.com | Europe - proinfo_power_emea@yageo.com | Asia - proinfo_power_asia@yageo.com

Performance warranty of products offered on this data sheet is limited to the parameters specified. Data is subject to change without notice. Other brand and product names mentioned herein may be trademarks or registered trademarks of their respective owners. © Copyright, 2023. Pulse Electronics, Inc. All rights reserved.

YAGEO Corporation and its affiliates do not recommend the use of commercial or automotive grade products for high reliability applications or manned space flight.