

# SN74LS257B, SN74LS258B

## Quad 2-Input Multiplexer with 3-State Outputs

The LSTTL/MSI SN74LS257B and the SN74LS258B are Quad 2-Input Multiplexers with 3-state outputs. Four bits of data from two sources can be selected using a Common Data Select input. The four outputs present the selected data in true (non-inverted) form. The outputs may be switched to a high impedance state with a HIGH on the common Output Enable ( $E_O$ ) Input, allowing the outputs to interface directly with bus oriented systems. It is fabricated with the Schottky barrier diode process for high speed and is completely compatible with all ON Semiconductor TTL families.

- Schottky Process For High Speed
- Multiplexer Expansion By Tying Outputs Together
- Non-Inverting 3-State Outputs
- Input Clamp Diodes Limit High Speed Termination Effects
- Special Circuitry Ensures Glitch Free Multiplexing
- ESD > 3500 Volts

### GUARANTEED OPERATING RANGES

Symbol	Parameter	Min	Typ	Max	Unit
$V_{CC}$	Supply Voltage	4.75	5.0	5.25	V
$T_A$	Operating Ambient Temperature Range	0	25	70	°C
$I_{OH}$	Output Current - High			-2.6	mA
$I_{OL}$	Output Current - Low			24	mA



ON Semiconductor™

<http://onsemi.com>

LOW  
POWER  
SCHOTTKY

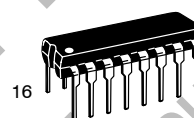

PLASTIC  
N SUFFIX  
CASE 648

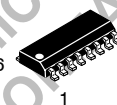

SOIC  
D SUFFIX  
CASE 751B

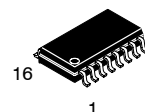

SOEIAJ  
M SUFFIX  
CASE 966

### ORDERING INFORMATION

Device	Package	Shipping
SN74LS257BN	16 Pin DIP	2000 Units/Box
SN74LS257BD	SOIC-16	38 Units/Rail
SN74LS257BDR2	SOIC-16	2500/Tape & Reel
SN74LS257BM	SOEIAJ-16	See Note 1
SN74LS257BMEL	SOEIAJ-16	See Note 1
SN74LS258BN	16 Pin DIP	2000 Units/Box
SN74LS258BD	SOIC-16	38 Units/Rail
SN74LS258BDR2	SOIC-16	2500/Tape & Reel
SN74LS258BM	SOEIAJ-16	See Note 1
SN74LS258BMEL	SOEIAJ-16	See Note 1

1. For ordering information on the EIAJ version of the SOIC package, please contact your local ON Semiconductor representative.

# SN74LS257B, SN74LS258B

## CONNECTION DIAGRAM DIP (TOP VIEW)

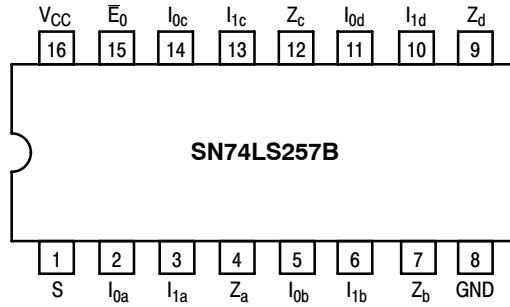

V<sub>CC</sub> = PIN 16  
GND = PIN 8

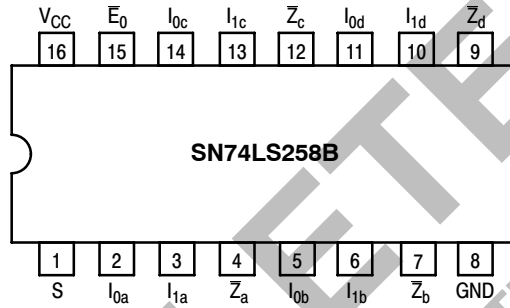

NOTE:  
The Flatpak version has the same pinouts (Connection Diagram) as the Dual In-Line Package.

**OBSOLETE**  
THIS DEVICE IS OBSOLETE  
PLEASE CONTACT YOUR ON SEMICONDUCTOR  
REPRESENTATIVE FOR INFORMATION

# SN74LS257B, SN74LS258B

## LOGIC DIAGRAMS

### SN74LS257B

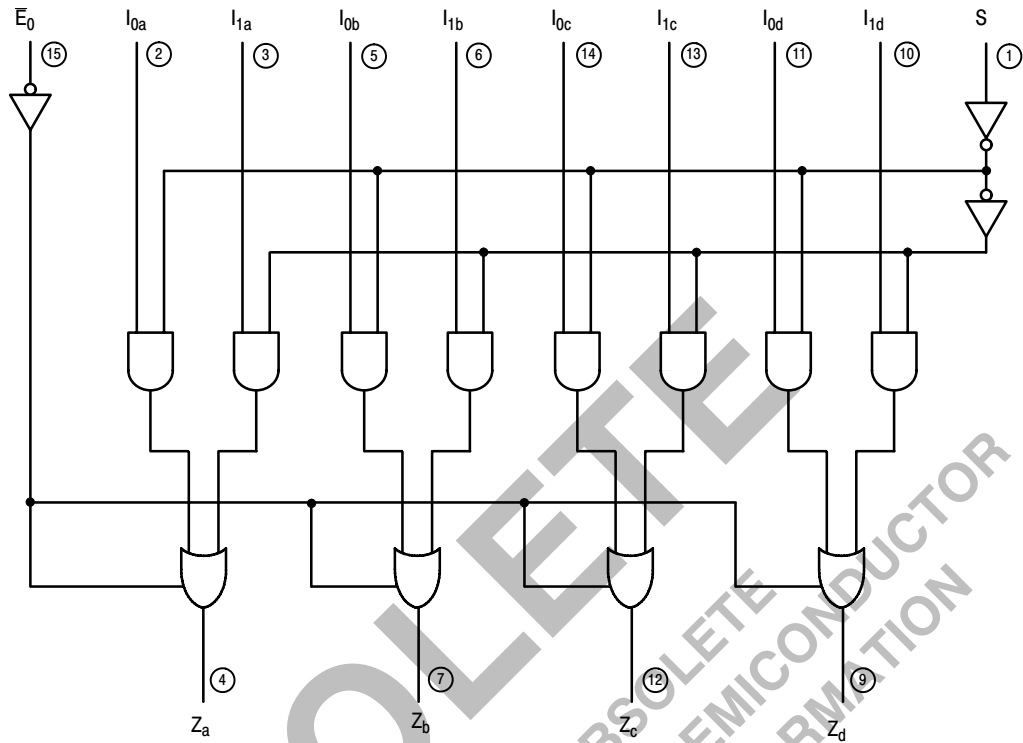

### SN74LS258B

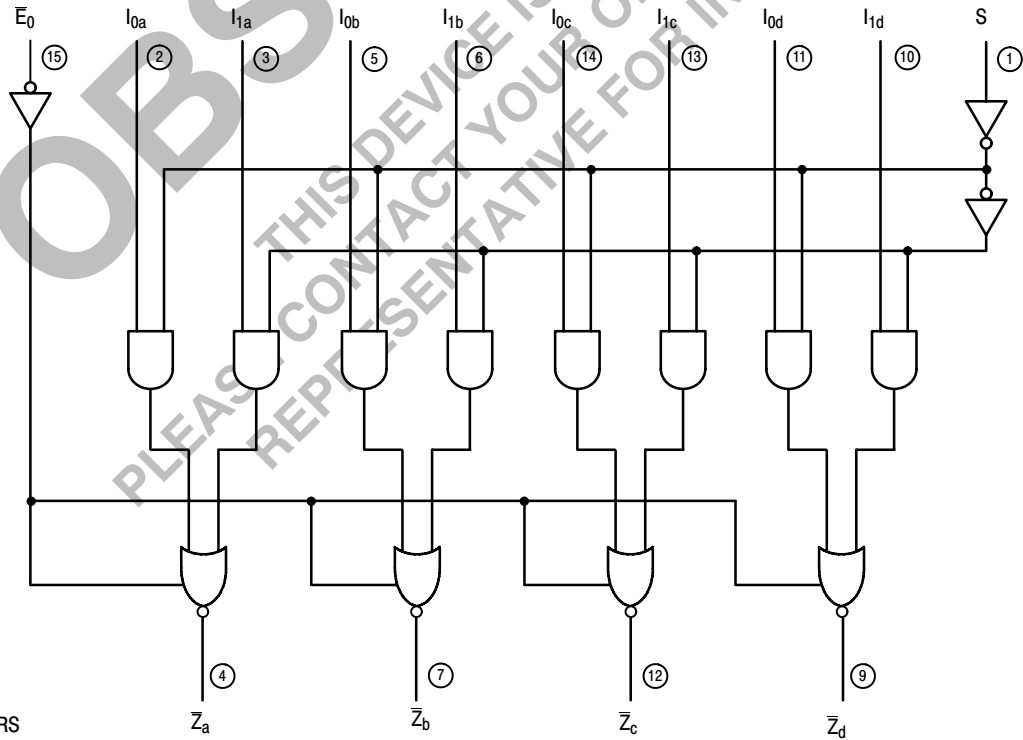

$V_{CC}$  = PIN 16  
 GND = PIN 8

○ = PIN NUMBERS

## SN74LS257B, SN74LS258B

### FUNCTIONAL DESCRIPTION

The LS257B and LS258B are Quad 2-Input Multiplexers with 3-state outputs. They select four bits of data from two sources each under control of a Common Data Select Input. When the Select Input is LOW, the I<sub>0</sub> inputs are selected and when Select is HIGH, the I<sub>1</sub> inputs are selected. The data on the selected inputs appears at the outputs in true (non-inverted) form for the LS257B and in the inverted form for the LS258B.

The LS257B and LS258B are the logic implementation of a 4-pole, 2-position switch where the position of the switch is determined by the logic levels supplied to the Select Input. The logic equations for the outputs are shown below:

#### LS257B

$$\begin{aligned} Z_a &= \bar{E}_0 \cdot (I_{1a} \cdot S + I_{0a} \cdot \bar{S}) \\ Z_b &= \bar{E}_0 \cdot (I_{1b} \cdot S + I_{0b} \cdot \bar{S}) \\ Z_c &= \bar{E}_0 \cdot (I_{1c} \cdot S + I_{0c} \cdot \bar{S}) \\ Z_d &= \bar{E}_0 \cdot (I_{1d} \cdot S + I_{0d} \cdot \bar{S}) \end{aligned}$$

When the Output Enable Input ( $\bar{E}_0$ ) is HIGH, the outputs are forced to a high impedance "off" state. If the outputs are tied together, all but one device must be in the high impedance state to avoid high currents that would exceed the maximum ratings. Designers should ensure that Output Enable signals to 3-state devices whose outputs are tied together are designed so there is no overlap.

#### LS258B

$$\begin{aligned} Z_a &= \bar{E}_0 \cdot (I_{1a} \cdot S + I_{0a} \cdot \bar{S}) \\ Z_b &= \bar{E}_0 \cdot (I_{1b} \cdot S + I_{0b} \cdot \bar{S}) \\ Z_c &= \bar{E}_0 \cdot (I_{1c} \cdot S + I_{0c} \cdot \bar{S}) \\ Z_d &= \bar{E}_0 \cdot (I_{1d} \cdot S + I_{0d} \cdot \bar{S}) \end{aligned}$$

TRUTH TABLE

OUTPUT ENABLE	SELECT INPUT	DATA INPUTS		OUTPUTS LS257B	OUTPUTS LS258B
$\bar{E}_0$	S	I <sub>0</sub>	I <sub>1</sub>	Z	Z
H	X	X	X	(Z)	(Z)
L	H	X	L	L	H
L	H	X	H	H	L
L	L	L	X	L	H
L	L	H	X	H	L

H = HIGH Voltage Level  
 L = LOW Voltage Level  
 X = Don't Care  
 (Z) = High Impedance (off)

# SN74LS257B, SN74LS258B

## DC CHARACTERISTICS OVER OPERATING TEMPERATURE RANGE (unless otherwise specified)

Symbol	Parameter	Limits			Unit	Test Conditions
		Min	Typ	Max		
V <sub>IH</sub>	Input HIGH Voltage	2.0			V	Guaranteed Input HIGH Voltage for All Inputs
V <sub>IL</sub>	Input LOW Voltage			0.8	V	Guaranteed Input LOW Voltage for All Inputs
V <sub>IK</sub>	Input Clamp Diode Voltage		-0.65	-1.5	V	V <sub>CC</sub> = MIN, I <sub>IN</sub> = -18 mA
V <sub>OH</sub>	Output HIGH Voltage	2.4	3.1		V	V <sub>CC</sub> = MIN, I <sub>OH</sub> = MAX, V <sub>IN</sub> = V <sub>IH</sub> or V <sub>IL</sub> per Truth Table
V <sub>OL</sub>	Output LOW Voltage		0.25	0.4	V	V <sub>CC</sub> = V <sub>CC</sub> MIN, V <sub>IN</sub> = V <sub>IL</sub> or V <sub>IH</sub> per Truth Table
			0.35	0.5	V	
I <sub>OZH</sub>	Output Off Current — HIGH			20	μA	V <sub>CC</sub> = MAX, V <sub>OUT</sub> = 2.7 V
I <sub>OZL</sub>	Output Off Current — LOW			-20	μA	V <sub>CC</sub> = MAX, V <sub>OUT</sub> = 0.4 V
I <sub>IH</sub>	Input HIGH Current Other Inputs S Inputs			20 40	μA	V <sub>CC</sub> = MAX, V <sub>IN</sub> = 2.7 V
	Other Inputs S Inputs			0.1 0.2	mA	V <sub>CC</sub> = MAX, V <sub>IN</sub> = 7.0 V
I <sub>IL</sub>	Input LOW Current All Inputs			-0.4	mA	V <sub>CC</sub> = MAX, V <sub>IN</sub> = 0.4 V
I <sub>OS</sub>	Short Circuit Current (Note 2)	-30		-130	mA	V <sub>CC</sub> = MAX
I <sub>CC</sub>	Power Supply Current					V <sub>CC</sub> = MAX
	Total, Output HIGH	LS257B LS258B		10 9.0	mA	
	Total, Output LOW	LS257B LS258B		16 14	mA	
	Total, Output 3-State	LS257B LS258B		19 16	mA	

2. Not more than one output should be shorted at a time, nor for more than 1 second.

## AC CHARACTERISTICS (T<sub>A</sub> = 25°C, V<sub>CC</sub> = 5.0 V) See SN74LS251 for Waveforms

Symbol	Parameter	Limits			Unit	Test Conditions
		Min	Typ	Max		
t <sub>PLH</sub> t <sub>PHL</sub>	Propagation Delay, Data to Output		10 12	13 15	ns	C <sub>L</sub> = 45 pF
t <sub>PLH</sub> t <sub>PHL</sub>	Propagation Delay, Select to Output		14 14	21 21	ns	
t <sub>PZH</sub>	Output Enable Time to HIGH Level		20	25	ns	C <sub>L</sub> = 45 pF R <sub>L</sub> = 667 Ω
t <sub>PZL</sub>	Output Enable Time to LOW Level		20	25	ns	
t <sub>PLZ</sub>	Output Disable Time to LOW Level		16	25	ns	C <sub>L</sub> = 5.0 pF R <sub>L</sub> = 667 Ω
t <sub>PHZ</sub>	Output Disable Time from HIGH Level		18	25	ns	

# SN74LS257B, SN74LS258B

## PACKAGE DIMENSIONS

N SUFFIX  
 PLASTIC PACKAGE  
 CASE 648-08  
 ISSUE R

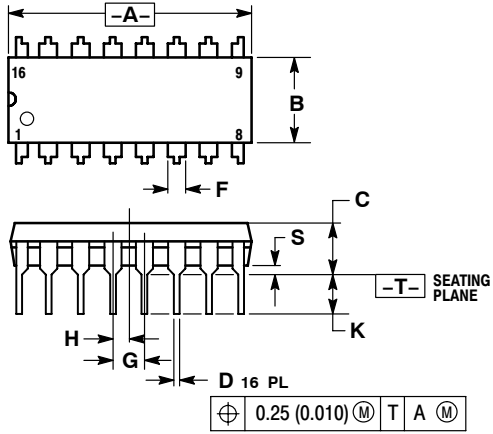

NOTES:

1. DIMENSIONING AND TOLERANCING PER ANSI Y14.5M, 1982.
2. CONTROLLING DIMENSION: INCH.
3. DIMENSION L TO CENTER OF LEADS WHEN FORMED PARALLEL.
4. DIMENSION B DOES NOT INCLUDE MOLD FLASH.
5. ROUNDED CORNERS OPTIONAL.

DIM	INCHES		MILLIMETERS	
	MIN	MAX	MIN	MAX
A	0.740	0.770	18.80	19.55
B	0.250	0.270	6.35	6.85
C	0.145	0.175	3.69	4.44
D	0.015	0.021	0.39	0.53
F	0.040	0.70	1.02	1.77
G	0.100 BSC		2.54 BSC	
H	0.050 BSC		1.27 BSC	
J	0.008	0.015	0.21	0.38
K	0.110	0.130	2.80	3.30
L	0.295	0.305	7.50	7.74
M	0° 10°		0° 10°	
S	0.020	0.040	0.51	1.01

OBSOLETE

THIS DEVICE IS OBSOLETE  
 PLEASE CONTACT YOUR ON SEMICONDUCTOR  
 REPRESENTATIVE FOR INFORMATION

# SN74LS257B, SN74LS258B

## PACKAGE DIMENSIONS

**D SUFFIX**  
 PLASTIC SOIC PACKAGE  
 CASE 751B-05  
 ISSUE J

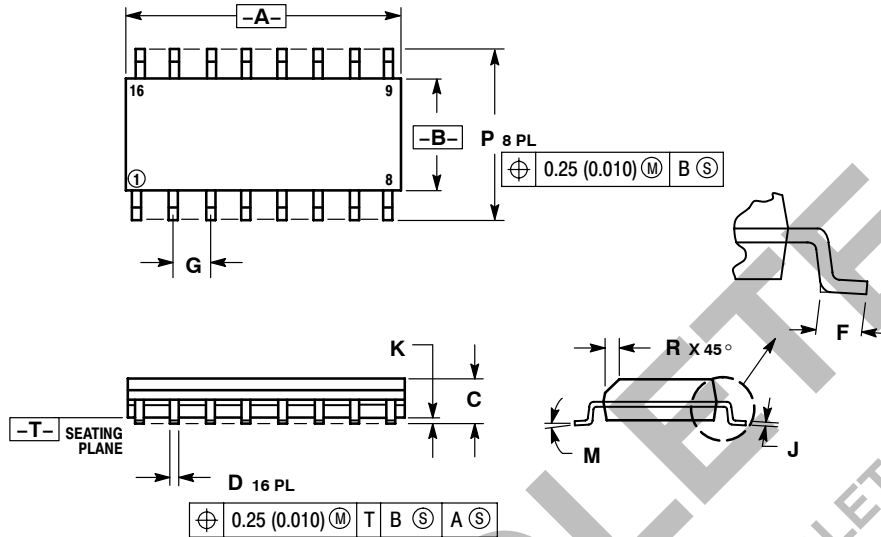

**NOTES:**

1. DIMENSIONING AND TOLERANCING PER ANSI Y14.5M, 1982.
2. CONTROLLING DIMENSION: MILLIMETER.
3. DIMENSIONS A AND B DO NOT INCLUDE MOLD PROTRUSION.
4. MAXIMUM MOLD PROTRUSION 0.15 (0.006) PER SIDE.
5. DIMENSION D DOES NOT INCLUDE DAMBAR PROTRUSION. ALLOWABLE DAMBAR PROTRUSION SHALL BE 0.127 (0.005) TOTAL IN EXCESS OF THE D DIMENSION AT MAXIMUM MATERIAL CONDITION.

DIM	MILLIMETERS		INCHES	
	MIN	MAX	MIN	MAX
A	9.80	10.00	0.386	0.393
B	3.80	4.00	0.150	0.157
C	1.35	1.75	0.054	0.068
D	0.35	0.49	0.014	0.019
F	0.40	1.25	0.016	0.049
G	1.27 BSC		0.050 BSC	
J	0.19	0.25	0.008	0.009
K	0.10	0.25	0.004	0.009
M	0°		7°	
P	5.80	6.20	0.229	0.244
R	0.25	0.50	0.010	0.019

OBSOLETE

THIS DEVICE IS OBSOLETE  
 PLEASE CONTACT YOUR ON SEMICONDUCTOR  
 REPRESENTATIVE FOR INFORMATION

# SN74LS257B, SN74LS258B

## PACKAGE DIMENSIONS

M SUFFIX  
SOEIAJ PACKAGE  
CASE 966-01  
ISSUE O

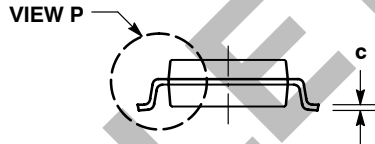
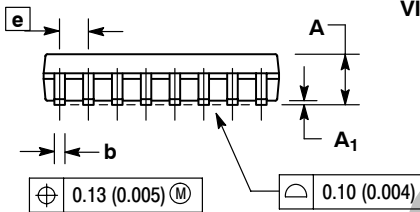
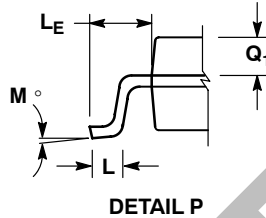
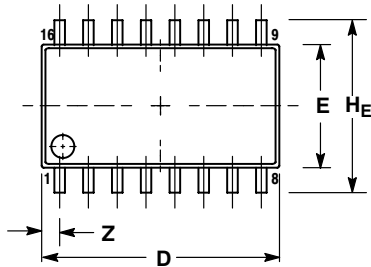

NOTES:

1. DIMENSIONING AND TOLERANCING PER ANSI Y14.5M, 1982.
2. CONTROLLING DIMENSION: MILLIMETER.
3. DIMENSIONS D AND E DO NOT INCLUDE MOLD FLASH OR PROTRUSIONS AND ARE MEASURED AT THE PARTING LINE. MOLD FLASH OR PROTRUSIONS SHALL NOT EXCEED 0.15 (0.006) PER SIDE.
4. TERMINAL NUMBERS ARE SHOWN FOR REFERENCE ONLY.
5. THE LEAD WIDTH DIMENSION (b) DOES NOT INCLUDE DAMBAR PROTRUSION. ALLOWABLE DAMBAR PROTRUSION SHALL BE 0.08 (0.003) TOTAL IN EXCESS OF THE LEAD WIDTH DIMENSION AT MAXIMUM MATERIAL CONDITION. DAMBAR CANNOT BE LOCATED ON THE LOWER RADIUS OR THE FOOT. MINIMUM SPACE BETWEEN PROTRUSIONS AND ADJACENT LEAD TO BE 0.46 (0.018).

DIM	MILLIMETERS		INCHES	
	MIN	MAX	MIN	MAX
A	---	2.05	---	0.081
A <sub>1</sub>	0.05	0.20	0.002	0.008
b	0.35	0.50	0.014	0.020
c	0.18	0.27	0.007	0.011
D	9.90	10.50	0.390	0.413
E	5.10	5.45	0.201	0.215
e	1.27 BSC		0.050 BSC	
HE	7.40	8.20	0.291	0.323
L	0.50	0.85	0.020	0.033
LE	1.10	1.50	0.043	0.059
M	0° 10°		0° 10°	
Q <sub>1</sub>	0.70	0.90	0.028	0.035
Z	---	0.78	---	0.031

**ON Semiconductor** and **ON** are registered trademarks of Semiconductor Components Industries, LLC (SCILLC). SCILLC reserves the right to make changes without further notice to any products herein. SCILLC makes no warranty, representation or guarantee regarding the suitability of its products for any particular purpose, nor does SCILLC assume any liability arising out of the application or use of any product or circuit, and specifically disclaims any and all liability, including without limitation special, consequential or incidental damages. "Typical" parameters which may be provided in SCILLC data sheets and/or specifications can and do vary in different applications and actual performance may vary over time. All operating parameters, including "Typicals" must be validated for each customer application by customer's technical experts. SCILLC does not convey any license under its patent rights nor the rights of others. SCILLC products are not designed, intended, or authorized for use as components in systems intended for surgical implant into the body, or other applications intended to support or sustain life, or for any other application in which the failure of the SCILLC product could create a situation where personal injury or death may occur. Should Buyer purchase or use SCILLC products for any such unintended or unauthorized application, Buyer shall indemnify and hold SCILLC and its officers, employees, subsidiaries, affiliates, and distributors harmless against all claims, costs, damages, and expenses, and reasonable attorney fees arising out of, directly or indirectly, any claim of personal injury or death associated with such unintended or unauthorized use, even if such claim alleges that SCILLC was negligent regarding the design or manufacture of the part. SCILLC is an Equal Opportunity/Affirmative Action Employer. This literature is subject to all applicable copyright laws and is not for resale in any manner.

### PUBLICATION ORDERING INFORMATION

**LITERATURE FULFILLMENT:**  
Literature Distribution Center for ON Semiconductor  
P.O. Box 5163, Denver, Colorado 80217 USA  
**Phone:** 303-675-2175 or 800-344-3860 Toll Free USA/Canada  
**Fax:** 303-675-2176 or 800-344-3867 Toll Free USA/Canada  
**Email:** orderlit@onsemi.com

**N. American Technical Support:** 800-282-9855 Toll Free USA/Canada  
**Europe, Middle East and Africa Technical Support:**  
Phone: 421 33 790 2910  
**Japan Customer Focus Center**  
Phone: 81-3-5773-3850

**ON Semiconductor Website:** [www.onsemi.com](http://www.onsemi.com)  
**Order Literature:** <http://www.onsemi.com/orderlit>

For additional information, please contact your local Sales Representative