

D44H8 / NZT44H8 / D44H11

NPN Power Amplifier

Features

- This device is designed for power amplifier, regulator and switching circuits where speed is important.
- Sourced from process 4Q.

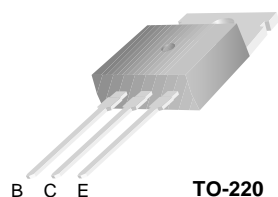

D44H8 / D44H11

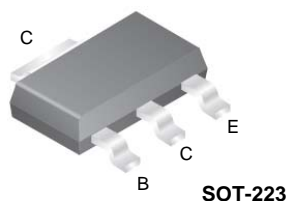

NZT44H8

Absolute Maximum Ratings* $T_A=25^\circ\text{C}$ unless otherwise noted

Symbol	Parameter	Value		Units
		D44H8 NZT44H8	D44H11	
V_{CE0}	Collector-Emitter Voltage	60	80	V
I_C	Collector Current - Continuous	8.0	10.0	A
T_J, T_{STG}	Operating and Storage Junction Temperature Range	-55 to +150		$^\circ\text{C}$

*These ratings are limiting values above which the serviceability of any semiconductor device may be impaired.

NOTES:

- 1) These ratings are based on a maximum junction temperature of 150°C .
- 2) These are steady state limits. The factory should be consulted on applications involving pulsed or low duty cycle operations.

Thermal Characteristics $T_A=25^\circ\text{C}$ unless otherwise noted

Symbol	Parameter	Max.		Units
		D44H8 D44H11	*NZT44H8	
P_D	Total Device Dissipation Derate above 25°C	60 480	1.5 12	W $\text{mW}/^\circ\text{C}$
$R_{\theta JC}$	Thermal Resistance, Junction to Case	2.1		$^\circ\text{C}/\text{W}$
$R_{\theta JA}$	Thermal Resistance, Junction to Ambient	62.5	83.3	$^\circ\text{C}/\text{W}$

*Device mounted on FR-4 PCB 36mm X 18mm X 1.5mm; mounting pad for the collector lead min. 6cm^2 .

Electrical Characteristics $T_A=25^\circ\text{C}$ unless otherwise noted

Symbol	Parameter	Test Condition	Min.	Max.	Units
Off Characteristics					
$V_{(BR)CEO}$	Collector-Emitter Breakdown Voltage	D44H8 / NZT44H8 D44H11 $I_C = 100\text{mA}, I_B = 0$	60 80		V
I_{CBO}	Collector-Cutoff Current	D44H8 / NZT44H8 D44H11 $V_{CB} = 60\text{V}, I_E = 0$ $V_{CB} = 80\text{V}, I_E = 0$		10	μA
I_{EBO}	Emitter-Cutoff Current	$V_{EB} = 5\text{V}, I_C = 0$		100	μA
On Characteristics					
h_{FE}	DC Current Gain	$V_{CE} = 1\text{V}, I_C = 2\text{A}$ $V_{CE} = 1\text{V}, I_C = 4\text{A}$	60 40		
$V_{CE(sat)}$	Collector-Emitter Saturation Voltage	$I_C = 8\text{A}, I_B = 0.4\text{A}$		1.0	V
$V_{BE(sat)}$	Base-Emitter Saturation Voltage	$I_C = 8\text{A}, I_B = 0.8\text{A}$		1.5	V
$V_{BE(on)}$	Base-Emitter On Voltage	$V_{CE} = 2\text{V}, I_C = 10\text{mA}$	0.52	0.65	V
Small Signal Characteristics					
f_T	Current Gain-Bandwidth Product	$I_C = 500\text{mA}, V_{CE} = 10\text{V}$	50		MHz

DC Typical Characteristics

Typical Pulsed Current Gain vs Collector Current

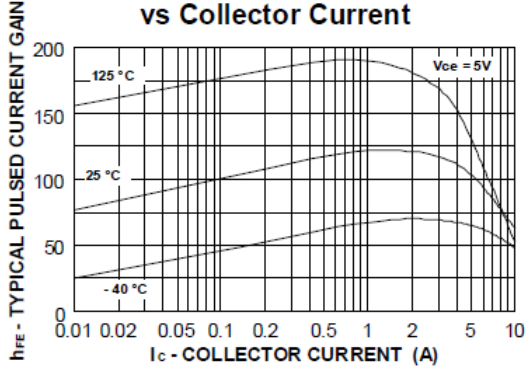

Collector-Emitter Saturation Voltage vs Collector Current

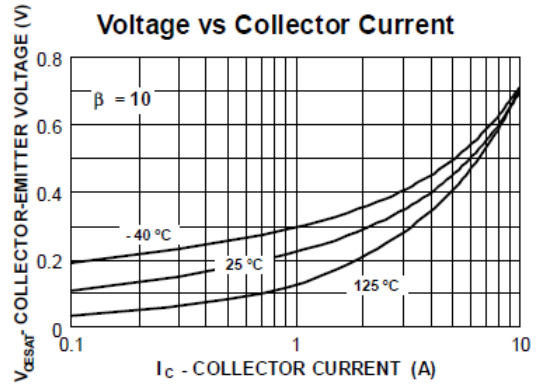

Base-Emitter Saturation Voltage vs Collector Current

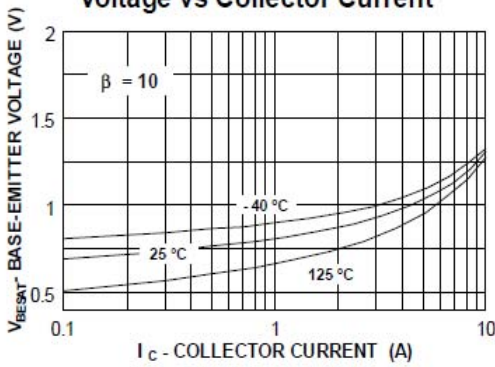

Base-Emitter ON Voltage vs Collector Current

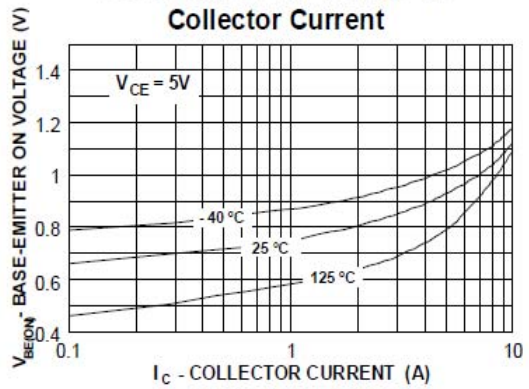

Collector-Cutoff Current vs Ambient Temperature

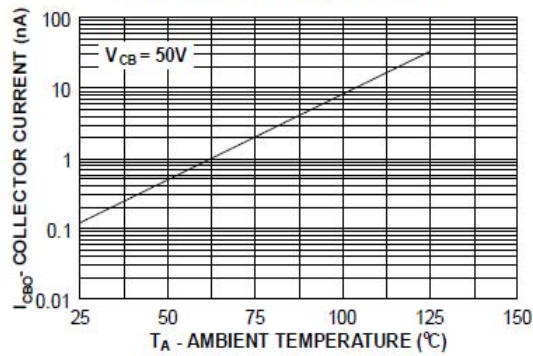

AC Typical Characteristics

Junction Capacitance vs. Reverse Bias Voltage

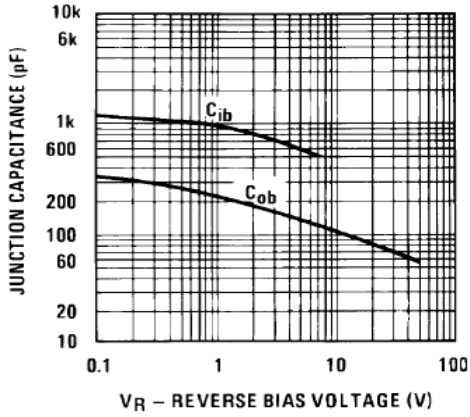

Safe Operating Area TO-220

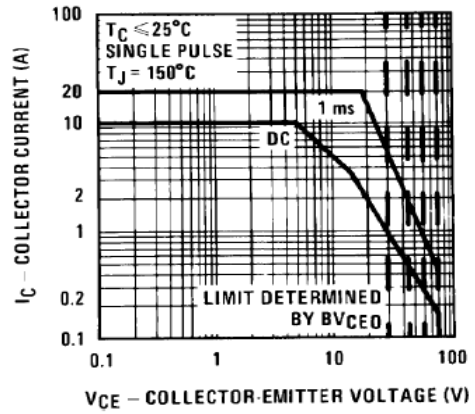

Maximum Power Dissipation vs. Case Temperature

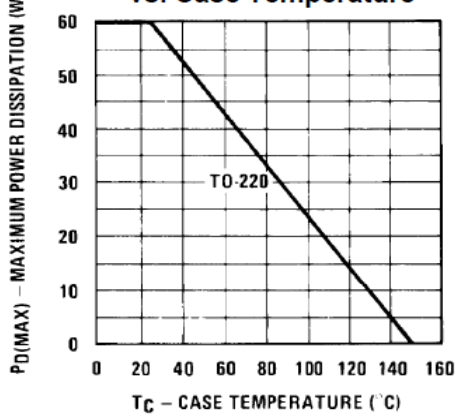

Maximum Power Dissipation vs. Ambient Temperature

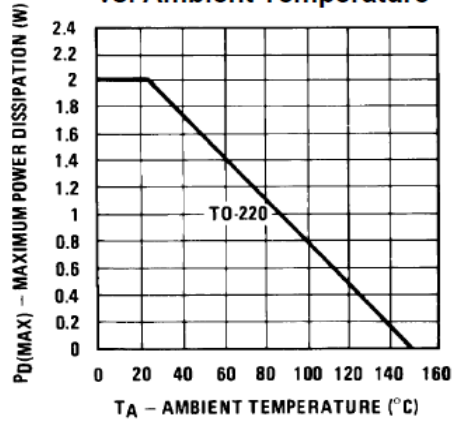

POWER DISSIPATION vs AMBIENT TEMPERATURE

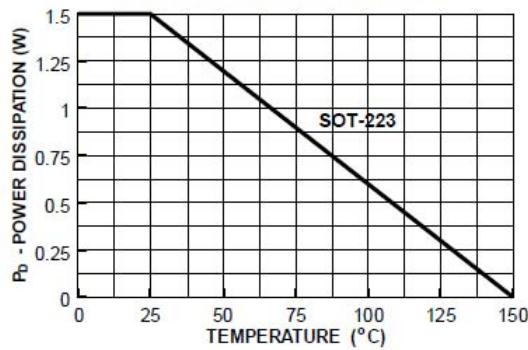

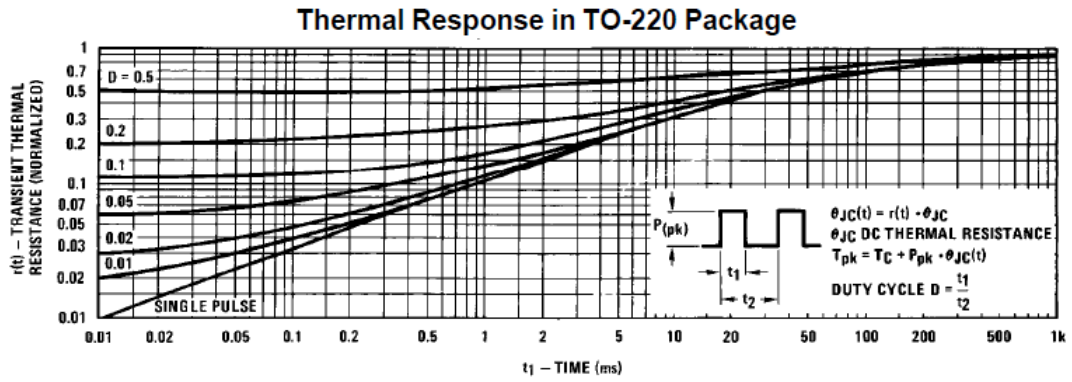

Physical Dimensions

TO-220

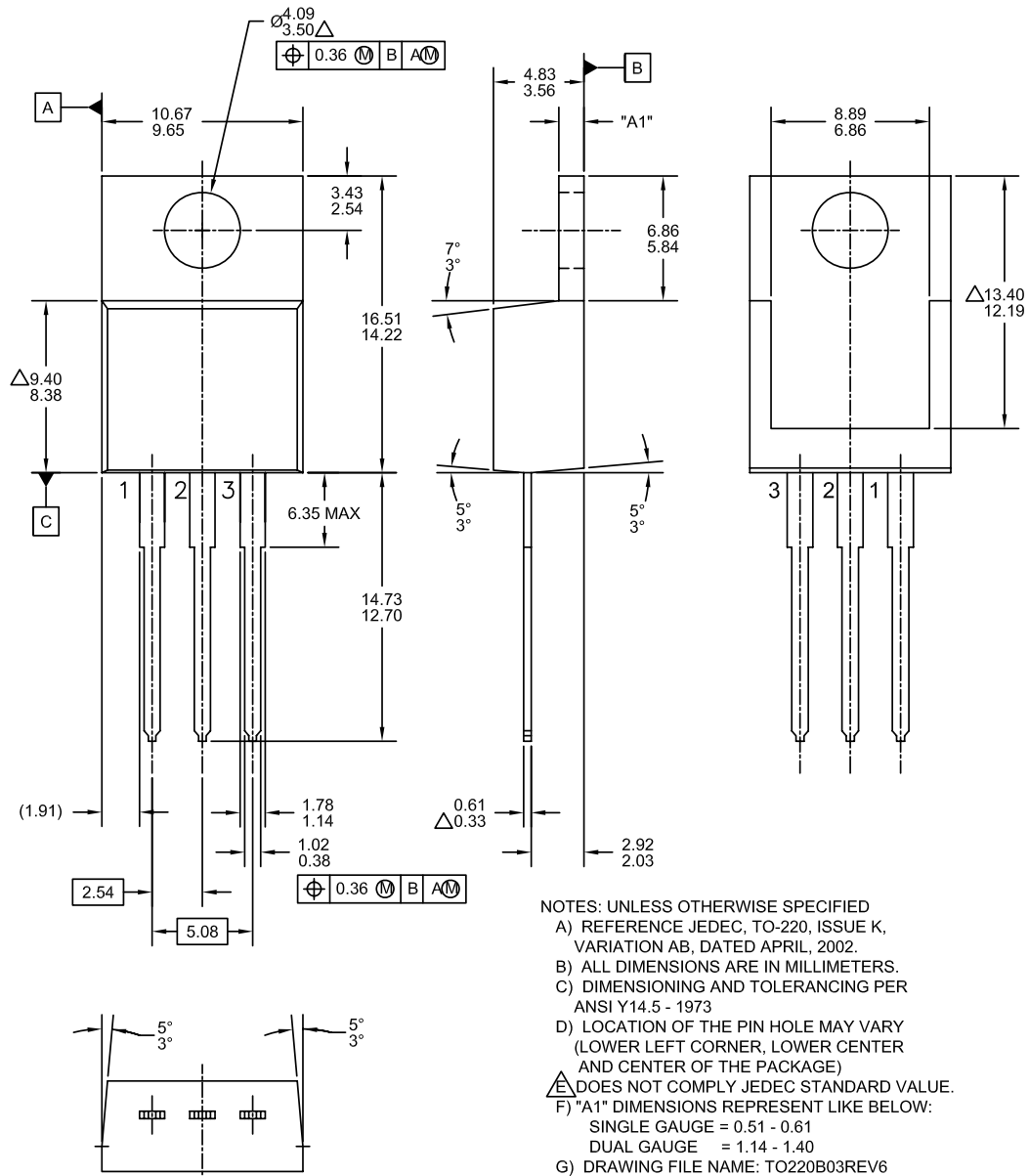

- NOTES: UNLESS OTHERWISE SPECIFIED
- A) REFERENCE JEDEC, TO-220, ISSUE K, VARIATION AB, DATED APRIL, 2002.
 - B) ALL DIMENSIONS ARE IN MILLIMETERS.
 - C) DIMENSIONING AND TOLERANCING PER ANSI Y14.5 - 1973
 - D) LOCATION OF THE PIN HOLE MAY VARY (LOWER LEFT CORNER, LOWER CENTER AND CENTER OF THE PACKAGE)
 - Δ DOES NOT COMPLY JEDEC STANDARD VALUE.
 - F) "A1" DIMENSIONS REPRESENT LIKE BELOW:
 SINGLE GAUGE = 0.51 - 0.61
 DUAL GAUGE = 1.14 - 1.40
 - G) DRAWING FILE NAME: TO220B03REV6

Dimensions in Millimeters

Physical Dimensions (Continued)

SOT-223

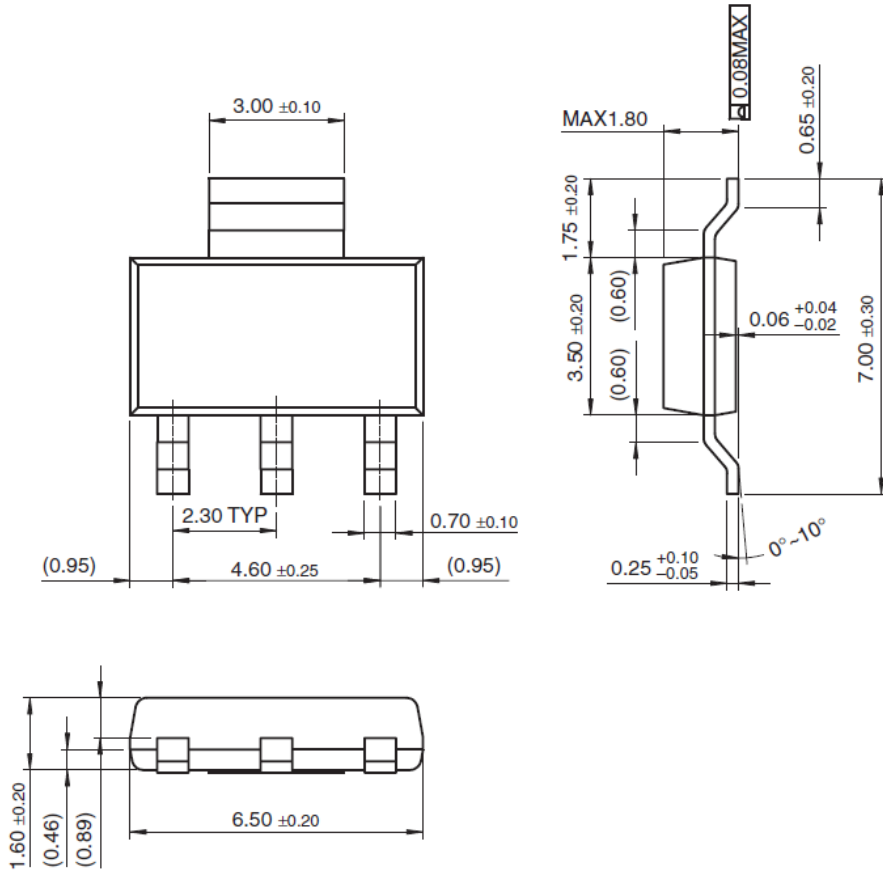





Dimensions in Millimeters



TRADEMARKS

The following includes registered and unregistered trademarks and service marks, owned by Fairchild Semiconductor and/or its global subsidiaries, and is not intended to be an exhaustive list of all such trademarks.

AccuPower™	FRFET®	PowerTrench®	The Power Franchise®
Auto-SPM™	Global Power Resource SM	PowerXS™	the power ™
Build it Now™	Green FPS™	Programmable Active Droop™	franchise
CorePLUS™	Green FPS™ e-Series™	QFET®	TinyBoost™
CorePOWER™	Gmax™	QS™	TinyBuck™
CROSSVOLT™	GTO™	Quiet Series™	TinyCalc™
CTL™	IntelliMAX™	RapidConfigure™	TinyLogic®
Current Transfer Logic™	ISOPLANAR™	 ™	TINYOPTO™
DEUXPEED®	MegaBuck™	Saving our world, 1mW/W/kW at a time™	TinyPower™
Dual Cool™	MICROCOUPLER™	SignalWise™	TinyPWM™
EcoSPARK®	MicroFET™	SmartMax™	TinyWire™
EfficientMax™	MicroPak™	SMART START™	TriFault Detect™
f ®	MicroPak2™	SPM®	TRUECURRENT™*
Fairchild®	MillerDrive™	STEALTH™	µSerDes™
Fairchild Semiconductor®	MotionMax™	SuperFET™	 ™
FACT Quiet Series™	Motion-SPM™	SuperSOT™-3	UHC®
FACT®	OptoHiT™	SuperSOT™-6	Ultra FRFET™
FAST®	OPTOLOGIC®	SuperSOT™-8	UniFET™
FastvCore™	OPTOPLANAR®	SupreMOS™	VCX™
FETBench™	 ®	SyncFET™	VisualMax™
FlashWriter®*	PDP SPM™	Sync-Lock™	XS™
FPS™	Power-SPM™	 ™	
F-PFS™			

* Trademarks of System General Corporation, used under license by Fairchild Semiconductor.

DISCLAIMER

FAIRCHILD SEMICONDUCTOR RESERVES THE RIGHT TO MAKE CHANGES WITHOUT FURTHER NOTICE TO ANY PRODUCTS HEREIN TO IMPROVE RELIABILITY, FUNCTION, OR DESIGN. FAIRCHILD DOES NOT ASSUME ANY LIABILITY ARISING OUT OF THE APPLICATION OR USE OF ANY PRODUCT OR CIRCUIT DESCRIBED HEREIN; NEITHER DOES IT CONVEY ANY LICENSE UNDER ITS PATENT RIGHTS, NOR THE RIGHTS OF OTHERS. THESE SPECIFICATIONS DO NOT EXPAND THE TERMS OF FAIRCHILD'S WORLDWIDE TERMS AND CONDITIONS, SPECIFICALLY THE WARRANTY THEREIN, WHICH COVERS THESE PRODUCTS.

LIFE SUPPORT POLICY

FAIRCHILD'S PRODUCTS ARE NOT AUTHORIZED FOR USE AS CRITICAL COMPONENTS IN LIFE SUPPORT DEVICES OR SYSTEMS WITHOUT THE EXPRESS WRITTEN APPROVAL OF FAIRCHILD SEMICONDUCTOR CORPORATION.

As used herein:

1. Life support devices or systems are devices or systems which, (a) are intended for surgical implant into the body or (b) support or sustain life, and (c) whose failure to perform when properly used in accordance with instructions for use provided in the labeling, can be reasonably expected to result in a significant injury of the user.
2. A critical component in any component of a life support, device, or system whose failure to perform can be reasonably expected to cause the failure of the life support device or system, or to affect its safety or effectiveness.

ANTI-COUNTERFEITING POLICY

Fairchild Semiconductor Corporation's Anti-Counterfeiting Policy. Fairchild's Anti-Counterfeiting Policy is also stated on our external website, www.fairchildsemi.com, under Sales Support.

Counterfeiting of semiconductor parts is a growing problem in the industry. All manufacturers of semiconductor products are experiencing counterfeiting of their parts. Customers who inadvertently purchase counterfeit parts experience many problems such as loss of brand reputation, substandard performance, failed applications, and increased cost of production and manufacturing delays. Fairchild is taking strong measures to protect ourselves and our customers from the proliferation of counterfeit parts. Fairchild strongly encourages customers to purchase Fairchild parts either directly from Fairchild or from Authorized Fairchild Distributors who are listed by country on our web page cited above. Products customers buy either from Fairchild directly or from Authorized Fairchild Distributors are genuine parts, have full traceability, meet Fairchild's quality standards for handling and storage and provide access to Fairchild's full range of up-to-date technical and product information. Fairchild and our Authorized Distributors will stand behind all warranties and will appropriately address any warranty issues that may arise. Fairchild will not provide any warranty coverage or other assistance for parts bought from Unauthorized Sources. Fairchild is committed to combat this global problem and encourage our customers to do their part in stopping this practice by buying direct or from authorized distributors.

PRODUCT STATUS DEFINITIONS

Definition of Terms

Datasheet Identification	Product Status	Definition
Advance Information	Formative / In Design	Datasheet contains the design specifications for product development. Specifications may change in any manner without notice.
Preliminary	First Production	Datasheet contains preliminary data; supplementary data will be published at a later date. Fairchild Semiconductor reserves the right to make changes at any time without notice to improve design.
No Identification Needed	Full Production	Datasheet contains final specifications. Fairchild Semiconductor reserves the right to make changes at any time without notice to improve the design.
Obsolete	Not In Production	Datasheet contains specifications on a product that is discontinued by Fairchild Semiconductor. The datasheet is for reference information only.

Rev. I47