

T-35-19

1-A *SwitchMax* **VERSAWATT Transistors**

High-Voltage N-P-N Types for Off-Line Power Supplies and Other High-Voltage Switching Applications

Features:

- High-temperature parameters guaranteed
- Fast switching speed
- High voltage ratings:
 $V_{CEX} = 350\text{ V to }450\text{ V}$
- Low $V_{CE(sat)}$ at $I_C = 1\text{ A}$
- **VERSAWATT** package

Applications:

- Off-line power supplies
- High-voltage inverters
- Switching regulators

TERMINAL DESIGNATIONS

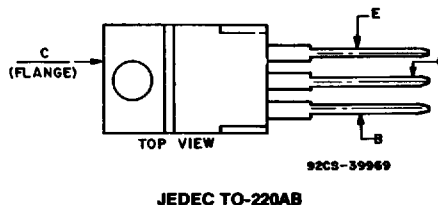

The 2N6771, 2N6772, and 2N6773* SwitchMax series of silicon n-p-n power transistors feature high-voltage capability, fast switching speeds, and low saturation voltages, together with high safe-operating-area (SOA) ratings. They are specially designed for off-line power supplies and are also well suited for use in a wide range of inverter or converter circuits, and pulse-width-modulated regulators. These high-voltage, high-speed transistors are tested for parameters that are essential to the design of high-power switching circuits. Switching

times, including inductive turn-off time, and saturation voltages are guaranteed at 125°C to provide information necessary for worst-case design.

The 2N6771, 2N6772, and 2N6773 series transistors are supplied in the JEDEC TO-220AB **VERSAWATT** plastic packages.

*Formerly RCA8863A, RCA8863B, and RCA8863C, respectively.

POWER TRANSISTORS

MAXIMUM RATINGS, Absolute-Maximum Values:

	2N6771	2N6772	2N6773	
* V_{CEV} $V_{BE} = -1.5\text{ V}$	450	550	650	V
* V_{CEX} (Clamped) $V_{BE} = -1.5\text{ V}$	350	400	450	V
* V_{CEO}	300	350	400	V
* V_{EBO}		8		V
* $I_{C(sat)}$		1		A
* I_C		1		A
* I_{CM}		2		A
* I_B		0.6		A
* P_T T_C up to 25°C		40		W
T_C above 25°C, derate linearly		0.32		W/°C
* T_{stg} T_J		-65 to 150		°C
* T_L At distance $\geq 1/8$ in. (3.17 mm) from seating plane for 10 s max.		235		°C

*In accordance with JEDEC registration data.

ELECTRICAL CHARACTERISTICS

T-35-19

CHARACTERISTIC	TEST CONDITIONS				LIMITS						UNITS
	VOLTAGE		CURRENT		2N6771		2N6772		2N6773		
	V _{dc}	V _{BE}	I _C	I _B	Min.	Max.	Min.	Max.	Min.	Max.	

T_C=25°C

I _{CEV}	450	-1.5			—	0.1	—	—	—	—	mA
	550	-1.5			—	—	—	0.1	—	—	
	650	-1.5			—	—	—	—	—	0.1	
I _{EBO}		-8	0		—	2	—	2	—	2	
V _{CEO(sus)} ^b			0.2 ^a	0	300	—	350	—	400	—	V
V _{CE(sat)}			1 ^a	0.2	—	1.0	—	1.0	—	1.0	
V _{BE(sat)}			1 ^a	0.2	—	1.2	—	1.2	—	1.2	
h _{FE}	3		0.3 ^a		20	100	20	100	20	100	
	3		1 ^a		10	50	10	50	10	50	
V _{CEX} ^b (Clamped E _{S/b}) L=450 μH, R _{BB} =50 Ω		-5	1	0.1 ^e	350	—	400	—	450	—	V
I _{S/b}	100		0.4		0.5	—	0.5	—	0.5	—	s
h _{fe} f=1 MHz	10		0.2		10	50	10	50	10	50	
f _T	10		0.2		10	50	10	50	10	50	MHz
C _{obo} f=0.1 MHz	10 ^c				20	60	20	60	20	60	pF
t _d ^d			1	0.2	—	0.05	—	0.05	—	0.05	μs
t _r ^d			1	0.2	—	0.4	—	0.4	—	0.4	
t _s ^d			1	0.2 ^e	—	2.5	—	2.5	—	2.5	
t _f ^d			1	0.2 ^e	—	0.6	—	0.6	—	0.6	
t _c V _{CC} =200 V, L=450 μH, R _C =200 Ω Collector clamped to V _{CEX}			1	0.2 ^e	—	0.6	—	0.6	—	0.6	

T_C=125°C

I _{CEV}	450	-1.5			—	1	—	—	—	—	mA
	550	-1.5			—	—	—	1	—	—	
	650	-1.5			—	—	—	—	—	1	
V _{CE(sat)}			1 ^a	0.2	—	2	—	2	—	2	V
t _r ^d			1	0.2	—	0.8	—	0.8	—	0.8	μs
t _s ^d			1	0.2 ^e	—	4.5	—	4.5	—	4.5	
t _f ^d			1	0.2 ^e	—	1.5	—	1.5	—	1.5	
t _c V _{CC} =200 V, L=450 μH, R _C =200 Ω Collector clamped to V _{CEX}			1	0.2 ^e	—	1.5	—	1.5	—	1.5	
R _{θJC}	20		1		—	3.12	—	3.12	—	3.12	
R _{θJA}					—	70	—	70	—	70	°C/W

^aIn accordance with JEDEC registration data.

^bPulsed: pulse duration = 300 μs, duty factor ≤ 2%.

^cCAUTION: The sustaining voltage V_{CEO(sus)}

and V_{CEX} MUST NOT be measured on a curve tracer.

^dV_{CB} value.

^eI_{B1} = -I_{B2}.

^fV_{CC} = 200 V, t_p = 20 μs.

T-35-19

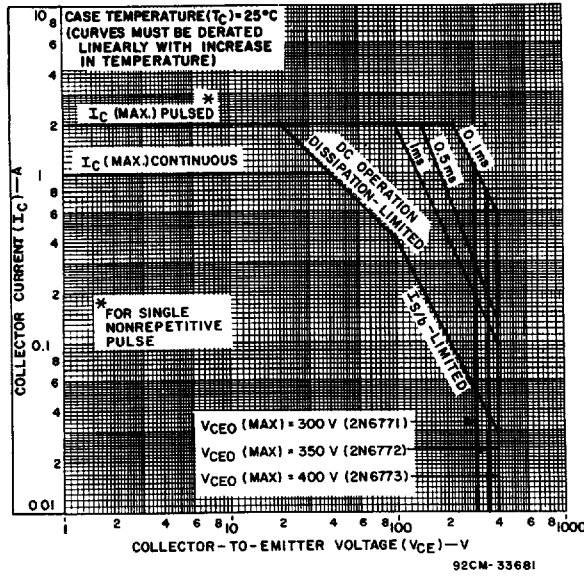

Fig. 1 — Maximum operating areas for all types.

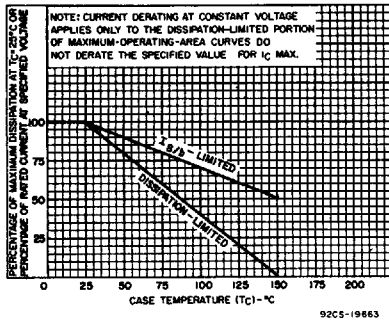

Fig. 2 — Derating curve for all types.

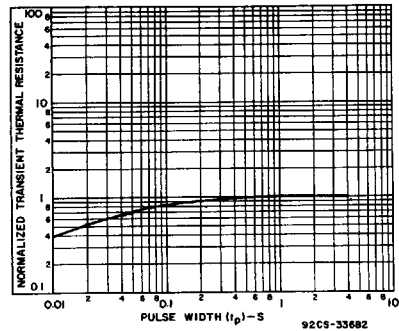

Fig. 3 — Typical thermal-response characteristics for all types.

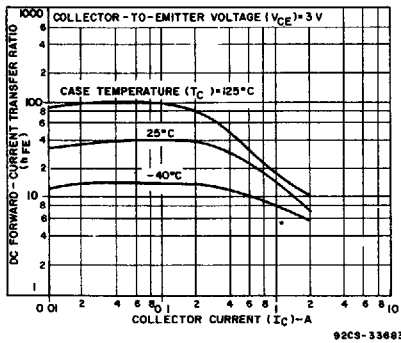

Fig. 4 — Typical dc beta characteristics for all types.

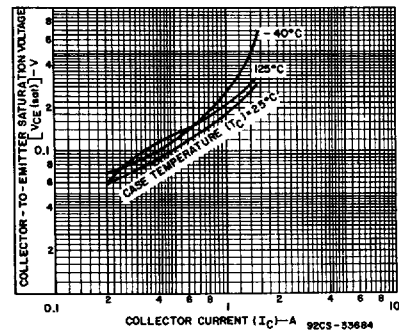

Fig. 5 — Typical collector-to-emitter saturation voltage as a function of collector current for all types.

POWER TRANSISTORS

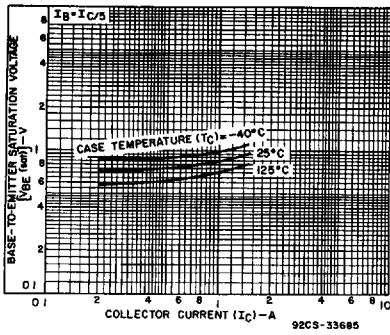

Fig. 6 — Typical base-to-emitter saturation voltage as a function of collector current for all types.

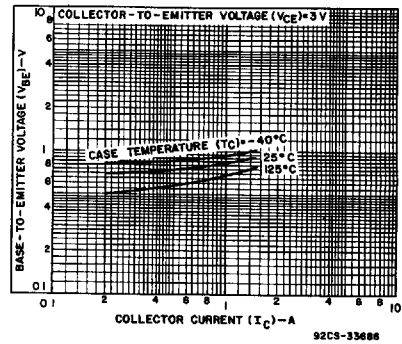

Fig. 7 — Typical base-to-emitter voltage as a function of collector current for all types.

T-35-19

HARRIS SEMICOND SECTOR

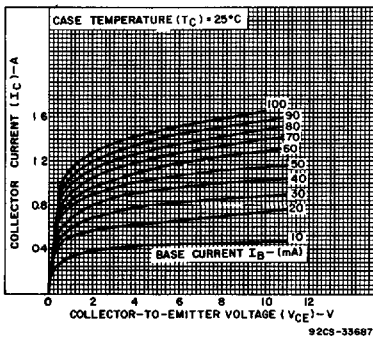

Fig. 8 — Typical output characteristics for all types.

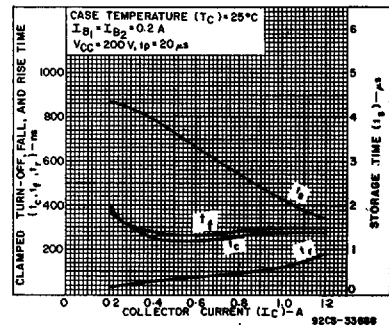

Fig. 9 — Typical saturated-switching-time characteristics for all types.

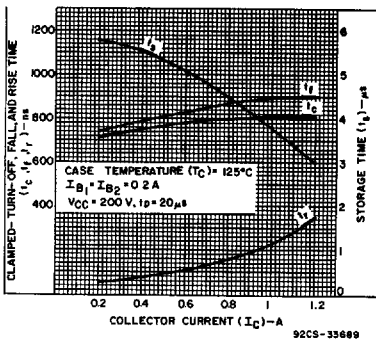

Fig. 10 — Typical saturated-switching-time characteristics as a function of collector current for all types.

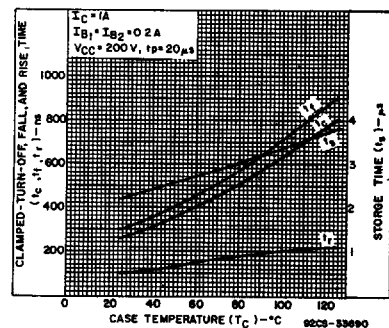

Fig. 11 — Typical saturated-switching-time characteristics as a function of case temperature for all types.

HARRIS SEMICOND SECTOR

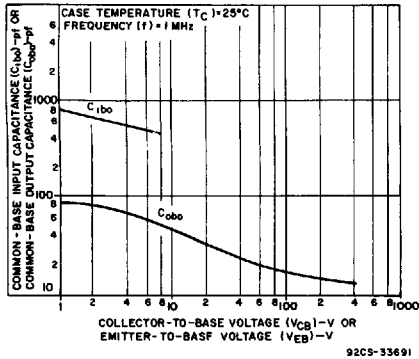

Fig. 12 — Typical common-base input or output capacitance characteristics as a function of collector-to-base voltage or emitter-to-base voltage for all types.

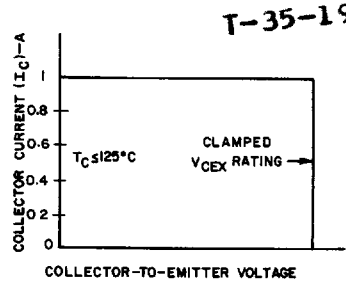

Fig. 13 — Maximum operating conditions for switching between saturation and cutoff.

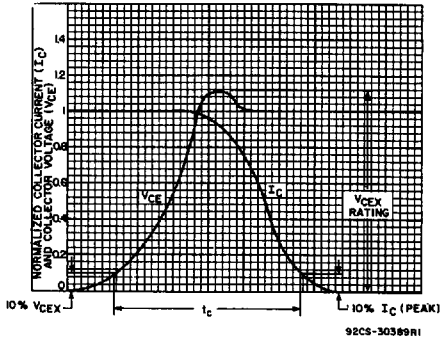

Fig. 14 — Oscilloscope display for measurement of clamped induction switching time (t_c).

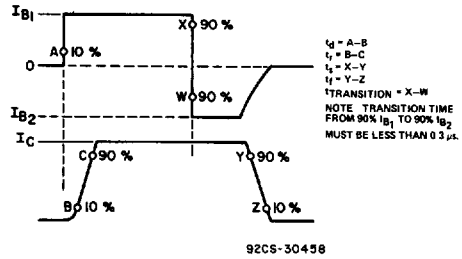

Fig. 15 — Phase relationship between input and output currents showing reference points for specification of switching times.

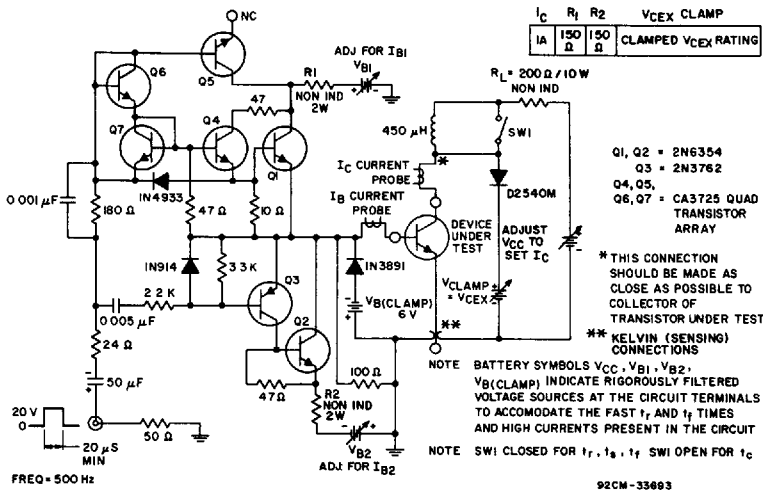

Fig. 16 — Circuit for measuring switching times.

POWER TRANSISTORS