

1

2

3

4

5

6

7

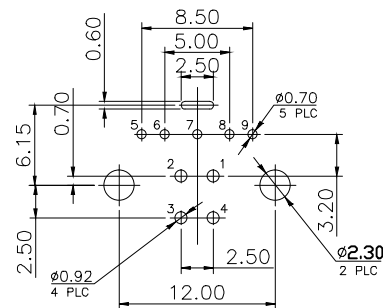
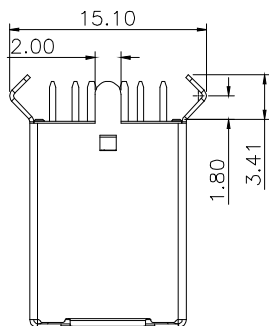
USB3.0 COMPLIANT

RECOMMEND P.C.B LAYOUT

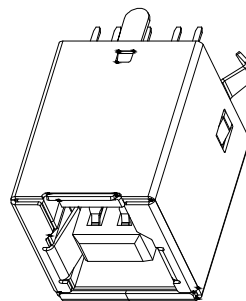
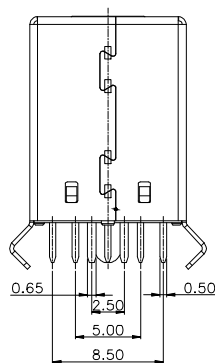
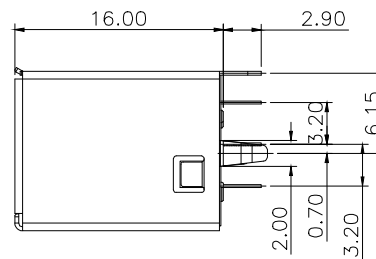
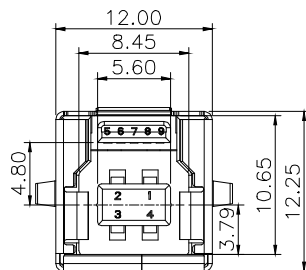

NOTE:

1.MATERIAL:

- 1.1 HOUSING: PBT UL 94V-0 Blue
- 1.2 CONTACT: Copper Alloy
- 1.3 SHELL: BRASS

2.PLATING:

- 2.1 CONTACT:
CONTACT AREA: 15U" Au
SOLDER AREA: TIN PLATED
UNDER PLATE: NI PLATED
- 2.2 SHELL: NI PLATED

3.MECHANICAL:

- 3.1 MATING FORCE: 3.57kg MAX
- 3.2 UNMATING FORCE: 1.02kg MIN
- 3.3 DURABILITY: 5000 CYCLES MIN

4.ELECTRICAL:

- 4.1 CONTACT RESISTANCE: 30mΩ MAX
- 4.2 CURRENT RATING: 1.5A
- 4.3 DIELECTRIC STRENGTH: 100V AC FOR 1MINUTE
- 4.4 INSULATION RESISTANCE 1000MΩ MIN

5.OPERATING TEMPERATURE: -55°C ~ 85°C

6.PACKING: TRAY

RoHS compliant
Unit: mm

Scale	Free					Date	Name	Customer-No.
TOLERANCE						Drawn	16.06.2015	Jesse
X.X	±0.30					Approved	16.06.2015	Jesse
X.XX	±0.20							
X.XXX	±0.10							
DIM	TOL							
		①	Drawn	16.06.2015	Jesse			
Angle		Id.	Modification	Date	Name			

ASSMANN WSW-No.

A-USB3 B-TOP

Drawing-No.

ASS 6865 CO

rev00

Replace

Sheet

1

2

3

4

5

6

7

SV3882