

DESCRIPTION

The MP3209 is a current mode step up converter intended for small, low power applications. The MP3209 switches at 1.4MHz and allows the use of tiny, low cost inductor and capacitor to achieve a solution less than 1mm in height. Internal soft start results in small inrush current and extends battery life.

The MP3209 includes under-voltage lockout, current limiting, and thermal overload protection to prevent damage in the event of an output overload. The MP3209 is available in small 5-pin TSOT23 and 2mm x 2mm ultra-thin QFN 8-pin packages.

FEATURES

- 2.5V to 6V Input Voltage Range
- On Board Power MOSFET
- Uses Tiny Capacitors and Inductors
- 1.4MHz Fixed Switching Frequency
- Internally Compensated
- Internal Soft-Start
- Operates with Input Voltage as Low as 2.5V and Output Voltage as High as 22V
- UVLO, Thermal Shutdown
- Internal Current Limit
- Available in TSOT23-5 and Ultra-Thin 2x2 QFN Packages

APPLICATIONS

- Cell Phones
- External Modems
- Small LCD Displays
- OLED Drivers

All MPS parts are lead-free and adhere to the RoHS directive. For MPS green status, please visit MPS website under Products, Quality Assurance page. "MPS" and "The Future of Analog IC Technology" are registered trademarks of Monolithic Power Systems, Inc.

TYPICAL APPLICATION

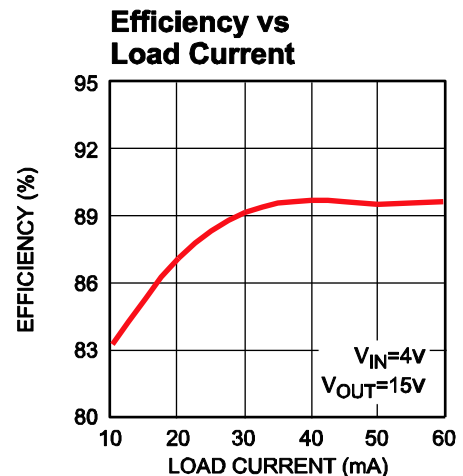
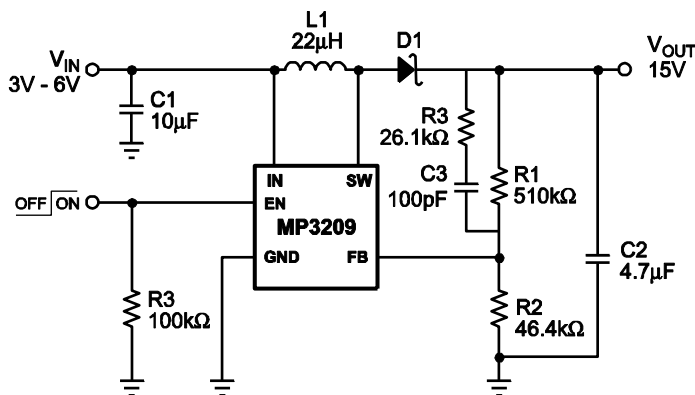

ORDERING INFORMATION

Part Number*	Package	Top Marking
MP3209DJ	TSOT23-5	N5
MP3209DGU	2x2 UTQFN	P7

* For Tape & Reel, add suffix -Z (e.g. MP3209DJ-Z);
 For RoHS compliant packaging, add suffix -LF (e.g. MP3209DJ-LF-Z)

* For Tape & Reel, add suffix -Z (e.g. MP3209DGU-Z);
 For RoHS compliant packaging, add suffix -LF (e.g. MP3209DGU-LF-Z)

PACKAGE REFERENCE

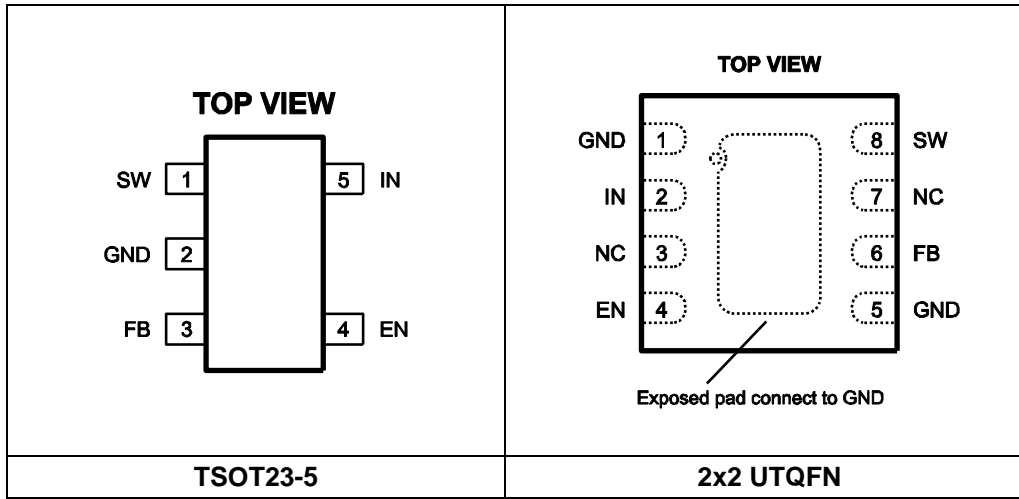

ABSOLUTE MAXIMUM RATINGS ⁽¹⁾

SW Pin	-0.3V to 25V
All Other Pins	-0.3V to 6.5V
Continuous Power Dissipation ($T_A = +25^\circ\text{C}$) ⁽²⁾	
TSOT23-5.....	0.57W
2x2 UTQFN.....	1.56W
Junction Temperature	150°C
Lead Temperature	260°C
Storage Temperature.....	-65°C to +150°C

Recommended Operating Conditions ⁽³⁾

Supply Voltage V_{IN}	2.5V to 6V
Output Voltage V_{OUT}	3V to 22V
Operating Temperature.....	-40°C to +85°C

Thermal Resistance ⁽⁴⁾ θ_{JA} θ_{JC}

TSOT23-5	220	110	°C/W
2x2 UTQFN	80	12	°C/W

Notes:

- Exceeding these ratings may damage the device.
- The maximum allowable power dissipation is a function of the maximum junction temperature T_J (MAX), the junction-to-ambient thermal resistance θ_{JA} , and the ambient temperature T_A . The maximum allowable continuous power dissipation at any ambient temperature is calculated by P_D (MAX) = $(T_J$ (MAX) - T_A) / θ_{JA} . Exceeding the maximum allowable power dissipation will cause excessive die temperature, and the regulator will go into thermal shutdown. Internal thermal shutdown circuitry protects the device from permanent damage.
- The device is not guaranteed to function outside of its operating conditions.
- Measured on JESD51-7, 4-layer PCB.

ELECTRICAL CHARACTERISTICS

$V_{IN} = V_{EN} = 5V$, $T_A = +25^{\circ}C$ unless otherwise specified.

Parameters	Symbol	Condition	Min	Typ	Max	Units
Operating Input Voltage	V_{IN}		2.5		6	V
UVLO Ramp Up	$V_{IN-UVLO}$			2.25	2.45	V
UVLO Hysteresis				92		mV
Supply Current (Shutdown)		$V_{EN} = 0V$		0.1	1	μA
Supply Current (Quiescent)		$V_{FB} = 1.3V$		635	850	μA
Switching Frequency	f_{SW}		1.15	1.4	1.65	MHz
Maximum Duty Cycle		$V_{FB} = 0V$	80	85		%
EN Threshold		V_{EN} Rising, $V_{IN}=2.5V$	1.0	1.3	1.6	V
EN Hysteresis				100		mV
EN Input Bias Current		$V_{EN} = 0V$, $V_{IN}=6V$			1	μA
FB Voltage	V_{FB}		1.21	1.25	1.29	V
FB Input Bias Current		$V_{FB} = 1.25V$	-100	-30		nA
SW On-Resistance ⁽⁴⁾	$R_{DS(ON)}$			0.5		Ω
SW Current Limit ⁽⁴⁾		Duty Cycle = 60%		0.35		A
SW Leakage		$V_{SW} = 15V$			1	μA
Thermal Shutdown ⁽⁴⁾				160		$^{\circ}C$

Note:

5) Guaranteed by design.

TYPICAL PERFORMANCE CHARACTERISTICS

C1=10μF, C2=4.7μF, L=22μH, R3=26.1kΩ, C3=100pF, Ta=25°C. Unless otherwise noted. (Figure 2)

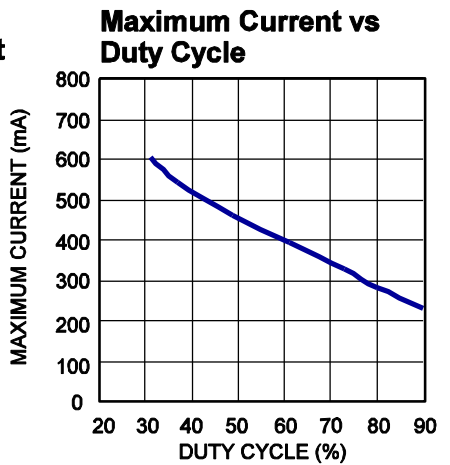
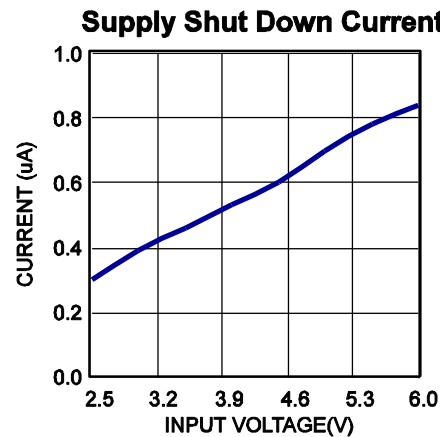
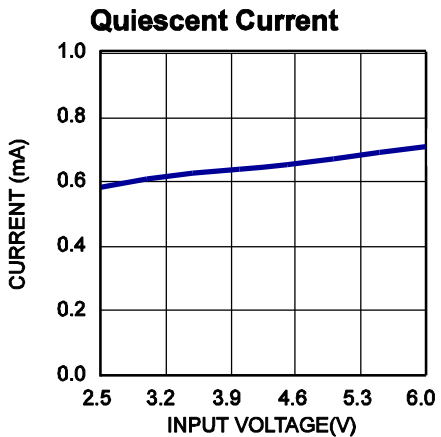
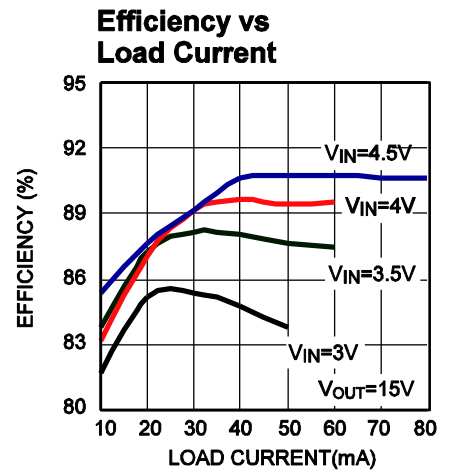
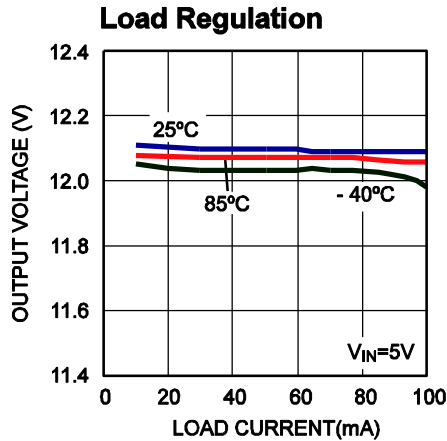
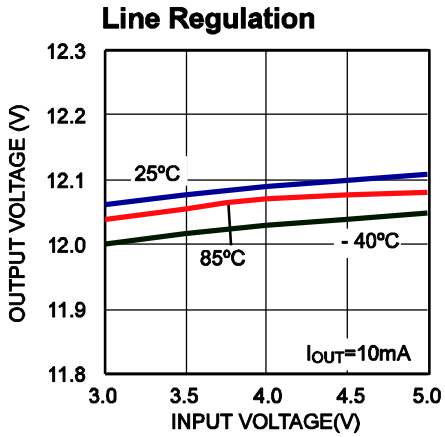
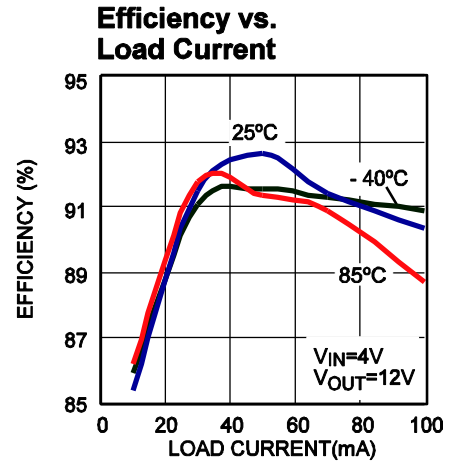
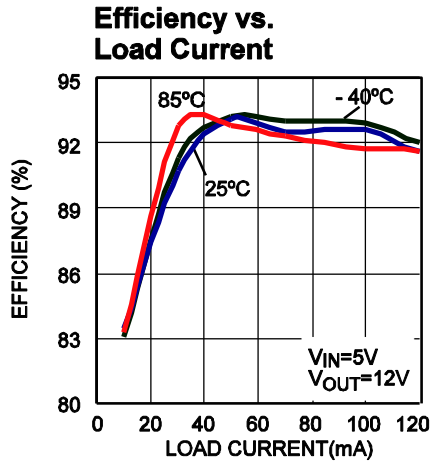
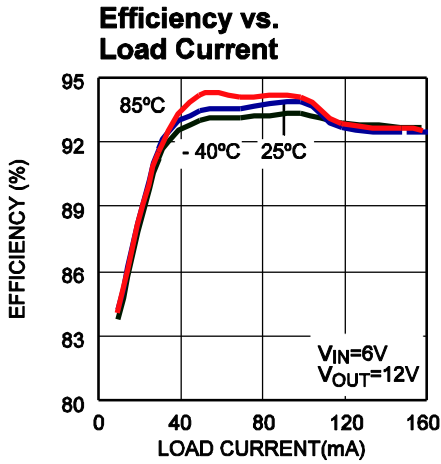

TYPICAL PERFORMANCE CHARACTERISTICS (continued)

C1=10 μ F, C2=4.7 μ F, L=22 μ H, R3=26.1k Ω , C3=100pF, Ta=25°C. Unless otherwise noted.

Enable Turn On vs. Outputs

V_{IN} = 3V, V_O = 15V, V_{EN} = 3V,
I_O = 30mA with Resistor load

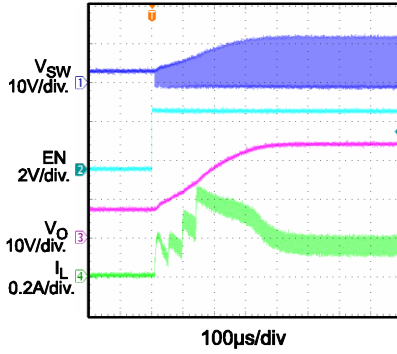
Enable Turn Off

V_{IN} = 3V, V_O = 15V, V_{EN} = 2V,
I_O = 30mA with Resistor load

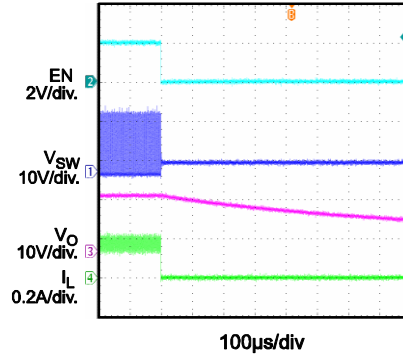
V_{IN} Ramp Up

V_{IN} = 3V, V_O = 15V, V_{EN} = 3V,
I_O = 30mA with Resistor load

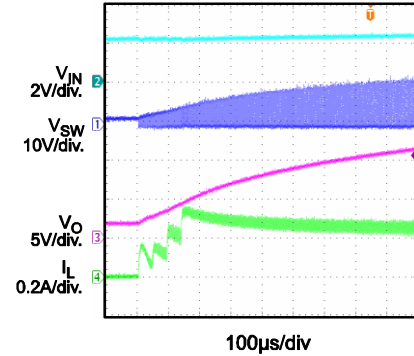
Line Transient

V_{IN} = V_{EN} = 4V to 5V, V_O = 12V
I_O = 60mA

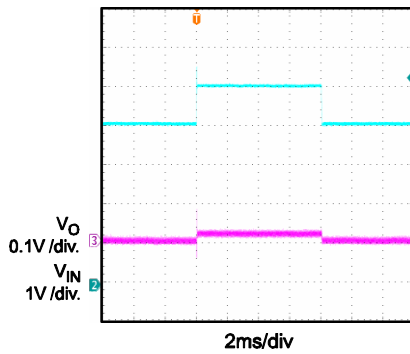
Steady State

V_{IN} = V_{EN} = 4V, V_O = 15V
I_O = 30mA

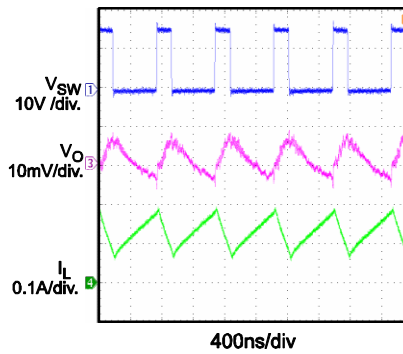
V_{IN} Ramp Up

V_{IN} = 3V, V_O = 15V, V_{EN} = 3V,
I_O = 30mA with Resistor load

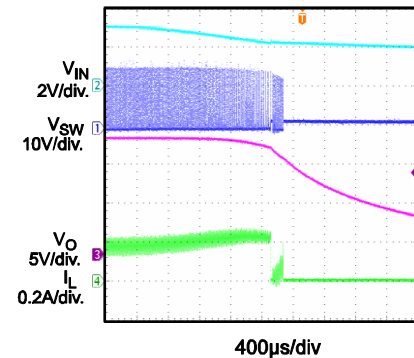
Load Transient

V_{IN} = 3.5V, V_O = 12V, V_{EN} = V_{IN},
I_O = 10mA to 60mA

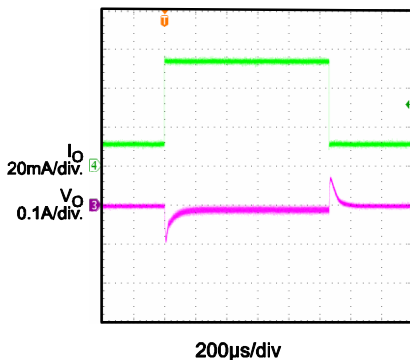
Thermal Protection

V_{IN} = V_{EN} = 3V, V_O = 12V
I_O = 50mA

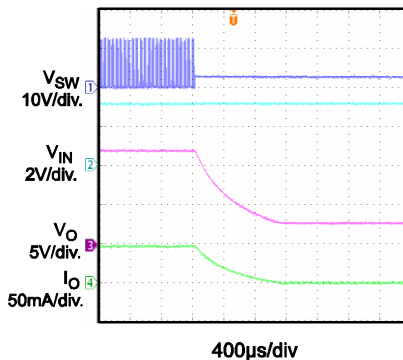
Thermal Protection Recovery

V_{IN} = V_{EN} = 3V, V_O = 12V
I_O = 50mA

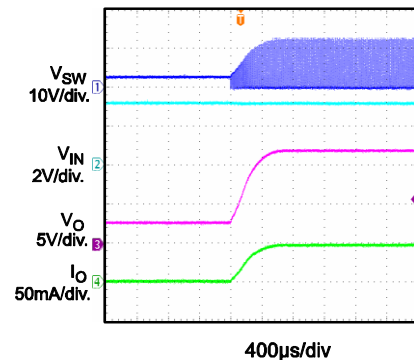

PIN FUNCTIONS

TSOT23-5 Pin #	UTQFN8 Pin #	Name	Function
1	8	SW	Power Switch Output. SW is the drain of the internal MOSFET switch. Connect the power inductor and output rectifier to SW. SW can swing between GND and 22V.
2	1, 5	GND	Ground.
3	6	FB	Feedback Input. FB voltage is 1.25V. Connect a resistor divider to FB.
4	4	EN	Regulator On/Off Control Input. A high input at EN turns on the converter, and a low input turns it off. When not used, connect EN to the input source for automatic startup. The EN pin cannot be left floating.
5	2	IN	Input Supply Pin. Must be locally bypassed.
	3, 7	NC	No Connect.

OPERATION

The MP3209 uses a fixed frequency, peak current mode boost regulator architecture to regulate voltage at the feedback pin. The operation of the MP3209 can be understood by referring to the block diagram of Figure 1. At the start of each oscillator cycle the MOSFET is turned on through the control circuitry. To prevent sub-harmonic oscillations at duty cycles greater than 50 percent, a stabilizing ramp is added to the output of the current sense amplifier and the result is fed into the negative input of the PWM comparator. When this voltage equals the output voltage of the error amplifier the power MOSFET is turned off. The voltage at the output of the error amplifier is an

amplified version of the difference between the 1.25V bandgap reference voltage and the feedback voltage. In this way the peak current level keeps the output in regulation. If the feedback voltage starts to drop, the output of the error amplifier increases. This results in more current to flow through the power MOSFET, thus increasing the power delivered to the output.

The MP3209 has internal soft start to limit the amount of input current at startup and to also limit the amount of overshoot on the output. The current limit is increased by a fourth every 40µs giving a total soft start time of 120µs.

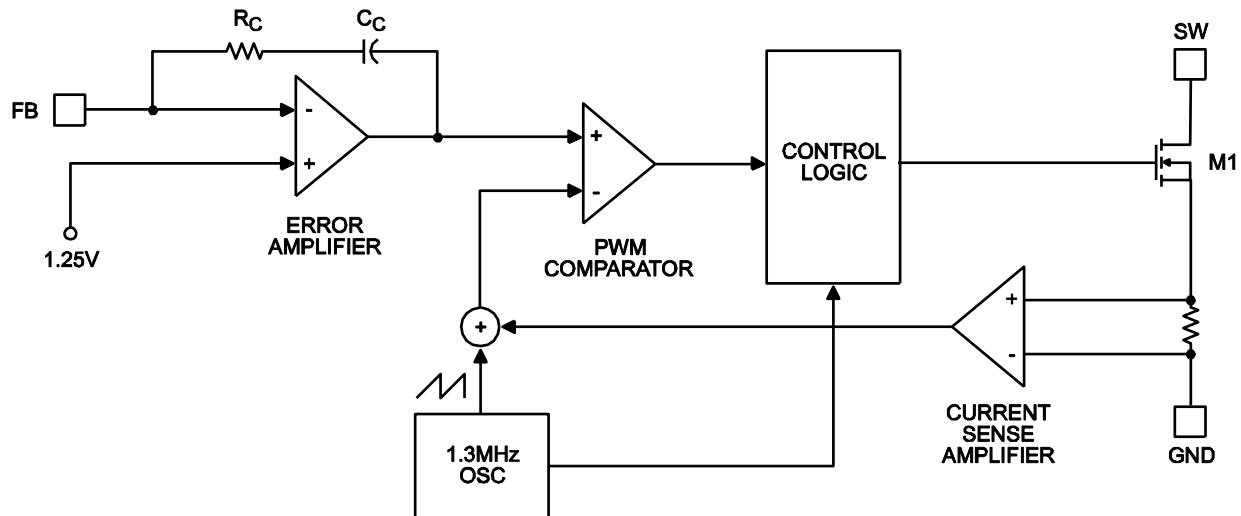

Figure 1—Functional Block Diagram

APPLICATIONS INFORMATION

COMPONENT SELECTION

Setting the Output Voltage

Set the output voltage by selecting the resistive voltage divider ratio. Use 510kΩ for the high-side resistor R1 of the voltage divider. Determine the low-side resistor R2 by the equation:

$$R2 = \frac{R1 \times V_{FB}}{V_{OUT} - V_{FB}}$$

where V_{OUT} is the output voltage.

(It is recommended to add feed-forward resistor R3 and C3 to improve the transient performance.) (Figure 2)

Selecting the Input Capacitor

An input capacitor is required to supply the AC ripple current to the inductor, while limiting noise at the input source. This capacitor must have low ESR, so ceramic is the best choice.

Use an input capacitor value of 4.7μF or greater. This capacitor must be placed physically close to the IN pin. Since it reduces the voltage ripple seen at IN, it also reduces the amount of EMI passed back along that line to the other circuitry.

Selecting the Output Capacitor

A single 4.7μF to 10μF ceramic capacitor usually provides sufficient output capacitance for most applications. If larger amount of capacitance is desired for improved line support and transient response, tantalum capacitors can be used in parallel with the ceramic. The impedance of the ceramic capacitor at the switching frequency is dominated by the capacitance, and so the output voltage ripple is mostly independent of the ESR. The output voltage ripple V_{RIPPLE} is calculated as:

$$V_{RIPPLE} = \frac{I_{LOAD} (V_{OUT} - V_{IN})}{V_{OUT} \times C2 \times f_{SW}}$$

Where V_{IN} is the input voltage, I_{LOAD} is the load current, C2 is the capacitance of the output capacitor, and f_{SW} is the 1.4MHz switching frequency.

Selecting the Inductor

The inductor is required to force the output voltage higher while being driven by the lower input voltage. Choose an inductor that does not saturate at the SW current limit. A good rule for determining the inductance is to allow the peak-to-peak ripple current to be approximately 30%-50% of the maximum input current. Make sure that the peak inductor current is below 75% of the typical current limit at the duty cycle used to prevent loss of regulation due to the current limit variation.

Calculate the required inductance value L using the equations:

$$L = \frac{V_{IN} (V_{OUT} - V_{IN})}{V_{OUT} \times f_{SW} \times \Delta I}$$

$$I_{IN(MAX)} = \frac{V_{OUT} \times I_{LOAD(MAX)}}{V_{IN} \times \eta}$$

$$\Delta I = (30\% - 50\%) I_{IN(MAX)}$$

Where $I_{LOAD(MAX)}$ is the maximum load current, ΔI is the peak-to-peak inductor ripple current, and η is efficiency. For the MP3209, 10μH is recommended for input voltages less than 3.3V and 22μH for inputs greater than 3.3V.

Selecting the Diode

The output rectifier diode supplies current to the inductor when the internal MOSFET is off. To reduce losses due to diode forward voltage and reverse recovery, use a Schottky diode. Choose a diode whose maximum reverse voltage rating is greater than the maximum output voltage. For output voltage less than 20V, it is recommended to choose the CMH5H-3 for most applications. This diode is used for load currents less than 300mA. For ultra-low-profile applications, choose BAT54-02 Schottky diode. Use two BAT54-02 in parallel for high load current.

LAYOUT CONSIDERATIONS

High frequency switching regulators require very careful layout for stable operation and low noise. All components must be placed as close to the IC as possible. Keep the path between MP3209, D1, and C2 extremely short for minimal noise and ringing. C1 must be placed close to the IN pin for best decoupling. All feedback components must be kept close to the FB pin to prevent noise injection on the FB pin trace. The ground return of C1 and C2 should be tied close to the GND pin. See the MP3209 demo board layout for reference.

TYPICAL APPLICATION CIRCUITS

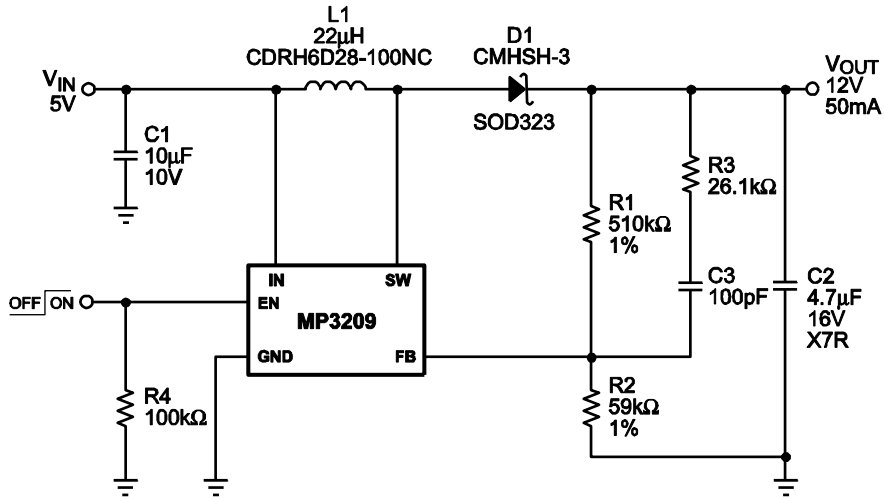
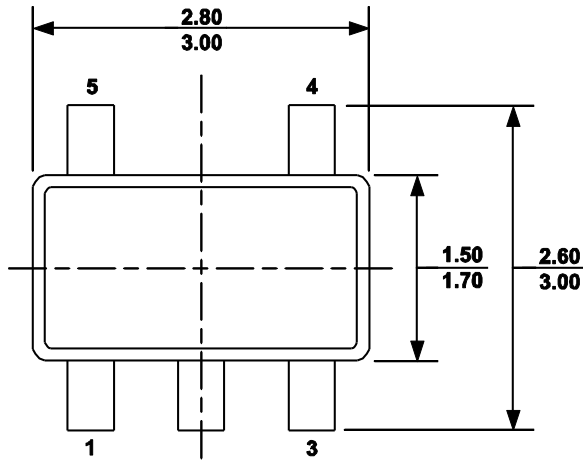

Figure 2— $V_{IN} = 5V$, $V_{OUT} = 12V$, $I_{OUT} = 50mA$ Boost Circuit

PACKAGE INFORMATION

TSOT23-5



TOP VIEW

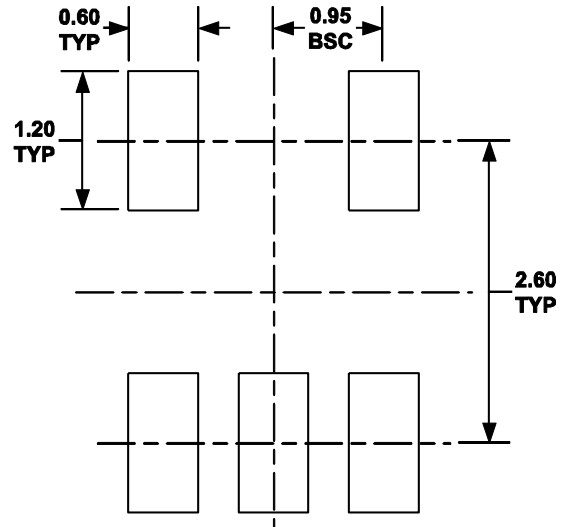

RECOMMENDED LAND PATTERN

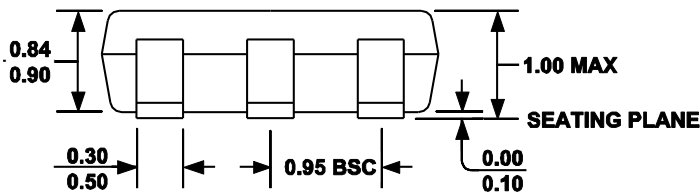

FRONT VIEW

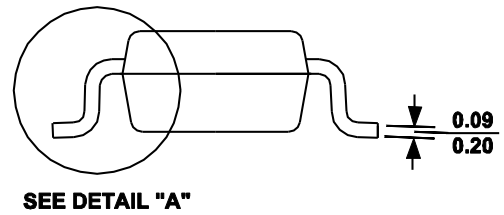

SEE DETAIL "A"

SIDE VIEW

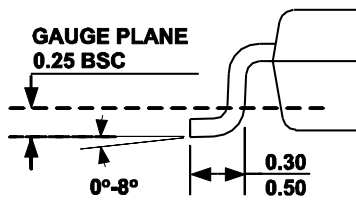

DETAIL "A"

NOTE:

- 1) ALL DIMENSIONS ARE IN MILLIMETERS.
- 2) PACKAGE LENGTH DOES NOT INCLUDE MOLD FLASH, PROTRUSION OR GATE BURR.
- 3) PACKAGE WIDTH DOES NOT INCLUDE INTERLEAD FLASH OR PROTRUSION.
- 4) LEAD COPLANARITY (BOTTOM OF LEADS AFTER FORMING) SHALL BE 0.10 MILLIMETERS MAX.
- 5) DRAWING CONFORMS TO JEDEC MO-193, VARIATION AA.
- 6) DRAWING IS NOT TO SCALE.

2mm x 2mm UTQFN8

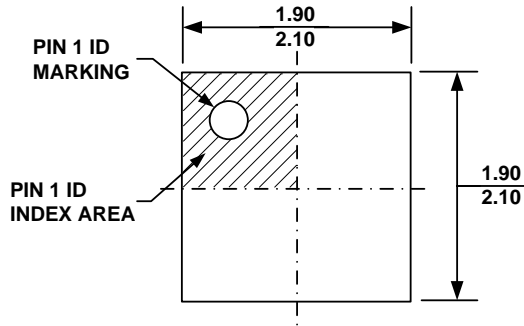

TOP VIEW

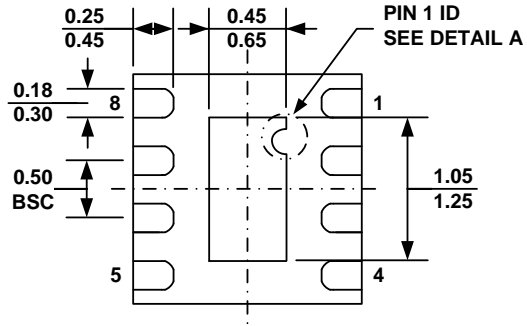

BOTTOM VIEW

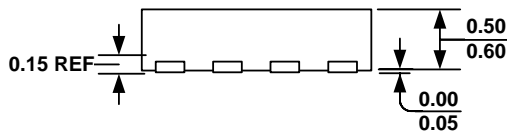

SIDE VIEW

**PIN 1 ID OPTION A
R0.10 TYP.**

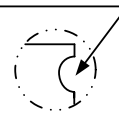

**PIN 1 ID OPTION B
R0.20 TYP.**

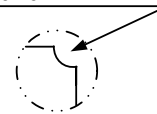

DETAIL A

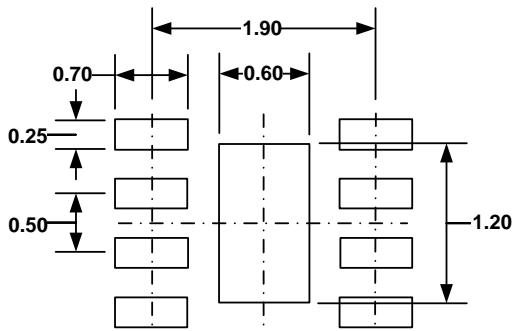

RECOMMENDED LAND PATTERN

NOTE:

- 1) ALL DIMENSIONS ARE IN MILLIMETERS.
- 2) EXPOSED PADDLE SIZE DOES NOT INCLUDE MOLD FLASH.
- 3) LEAD COPLANARITY SHALL BE 0.10 MILLIMETER MAX.
- 4) JEDEC REFERENCE IS MO-229, VARIATION VCCD-3.
- 5) DRAWING IS NOT TO SCALE.

NOTICE: The information in this document is subject to change without notice. Users should warrant and guarantee that third party Intellectual Property rights are not infringed upon when integrating MPS products into any application. MPS will not assume any legal responsibility for any said applications.