

1200V XPT™ Gen 4 IGBT

IXYK110N120B4

Extreme Light Punch Through IGBT for 5-30 kHz Switching

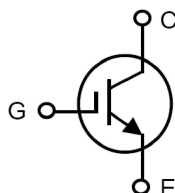

$V_{CES} = 1200V$
 $I_{C110} = 110A$
 $V_{CE(sat)} \leq 2.10V$
 $t_{fi(typ)} = 130ns$

TO-264 (IXYK)

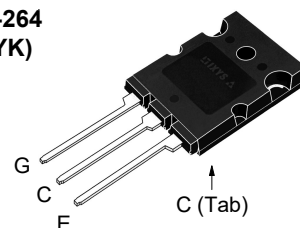

G = Gate C = Collector
 E = Emitter Tab = Collector

Symbol	Test Conditions	Maximum Ratings	
V_{CES}	$T_J = 25^\circ C$ to $175^\circ C$	1200	V
V_{CGR}	$T_J = 25^\circ C$ to $175^\circ C$, $R_{GE} = 1M\Omega$	1200	V
V_{GES}	Continuous	± 20	V
V_{GEM}	Transient	± 30	V
I_{C25}	$T_C = 25^\circ C$ (Chip Capability)	340	A
I_{LRMS}	Terminal Current Limit	160	A
I_{C110}	$T_C = 110^\circ C$	110	A
I_{CM}	$T_C = 25^\circ C$, 1ms	800	A
SSOA (RBSOA)	$V_{GE} = 15V$, $T_{VJ} = 150^\circ C$, $R_G = 2\Omega$ Clamped Inductive Load	$I_{CM} = 220$ $0.8 \cdot V_{CES}$	A V
P_C	$T_C = 25^\circ C$	1360	W
T_J		-55 ... +175	$^\circ C$
T_{JM}		175	$^\circ C$
T_{stg}		-55 ... +175	$^\circ C$
T_L	Maximum Lead Temperature for Soldering 1.6 mm (0.062 in.) from Case for 10s	300	$^\circ C$
M_d	Mounting Torque	1.13/10	Nm/lb.in.
Weight		10	g

Features

- Optimized for 5-30kHz Switching
- Positive Thermal Coefficient of $V_{ce(sat)}$
- International Standard Package

Advantages

- High Power Density
- Low Gate Drive Requirement

Applications

- Power Inverters
- UPS
- Motor Drives
- SMPS
- PFC Circuits
- Battery Chargers
- Welding Machines
- Lamp Ballasts

Symbol	Test Conditions ($T_J = 25^\circ C$, Unless Otherwise Specified)	Characteristic Values		
		Min.	Typ.	Max.
BV_{CES}	$I_C = 250\mu A$, $V_{GE} = 0V$	1200		V
$V_{GE(th)}$	$I_C = 3mA$, $V_{CE} = V_{GE}$	4.5		6.5 V
I_{CES}	$V_{CE} = V_{CES}$, $V_{GE} = 0V$ $T_J = 150^\circ C$			25 μA 1.5 mA
I_{GES}	$V_{CE} = 0V$, $V_{GE} = \pm 20V$			± 100 nA
$V_{CE(sat)}$	$I_C = I_{C110}$, $V_{GE} = 15V$, Note 1 $T_J = 150^\circ C$		1.66 1.95	2.10 V V

Symbol	Test Conditions ($T_J = 25^\circ\text{C}$ Unless Otherwise Specified)	Characteristic Values		
		Min.	Typ.	Max.
g_{fs}	$I_C = 55\text{A}, V_{CE} = 10\text{V}$, Note 1	40	68	S
C_{ies}	} $V_{CE} = 25\text{V}, V_{GE} = 0\text{V}, f = 1\text{MHz}$		5460	pF
C_{oes}			340	pF
C_{res}			220	pF
$Q_{g(on)}$	} $I_C = I_{C110}, V_{GE} = 15\text{V}, V_{CE} = 0.5 \cdot V_{CES}$		340	nC
Q_{ge}			52	nC
Q_{gc}			144	nC
$t_{d(on)}$	} Inductive load, $T_J = 25^\circ\text{C}$ $I_C = 50\text{A}, V_{GE} = 15\text{V}$ $V_{CE} = 0.5 \cdot V_{CES}, R_G = 2\Omega$ Note 2		45	ns
t_{ri}			50	ns
E_{on}			3.60	mJ
$t_{d(off)}$			390	ns
t_{fi}			130	ns
E_{off}			3.85	mJ
$t_{d(on)}$		} Inductive load, $T_J = 150^\circ\text{C}$ $I_C = 50\text{A}, V_{GE} = 15\text{V}$ $V_{CE} = 0.5 \cdot V_{CES}, R_G = 2\Omega$ Note 2		34
t_{ri}			38	ns
E_{on}			4.96	mJ
$t_{d(off)}$			440	ns
t_{fi}			210	ns
E_{off}			6.45	mJ
R_{thJC}				0.11 $^\circ\text{C/W}$
R_{thCS}		0.15	$^\circ\text{C/W}$	

Notes:

1. Pulse test, $t \leq 300\mu\text{s}$, duty cycle, $d \leq 2\%$.
2. Switching times & energy losses may increase for higher V_{CE} (clamp), T_J or R_G .

Littelfuse reserves the right to change limits, test conditions, and dimensions.

IXYS MOSFETs and IGBTs are covered	4,835,592	4,931,844	5,049,961	5,237,481	6,162,665	6,404,065 B1	6,683,344	6,727,585	7,005,734 B2	7,157,338B2
by one or more of the following U.S. patents:	4,860,072	5,017,508	5,063,307	5,381,025	6,259,123 B1	6,534,343	6,710,405 B2	6,759,692	7,063,975 B2	
	4,881,106	5,034,796	5,187,117	5,486,715	6,306,728 B1	6,583,505	6,710,463	6,771,478 B2	7,071,537	

Fig. 1. Output Characteristics @ $T_J = 25^\circ\text{C}$

Fig. 2. Extended Output Characteristics @ $T_J = 25^\circ\text{C}$

Fig. 3. Output Characteristics @ $T_J = 150^\circ\text{C}$

Fig. 4. Dependence of $V_{CE(sat)}$ on Junction Temperature

Fig. 5. Collector-to-Emitter Voltage vs. Gate-to-Emitter Voltage

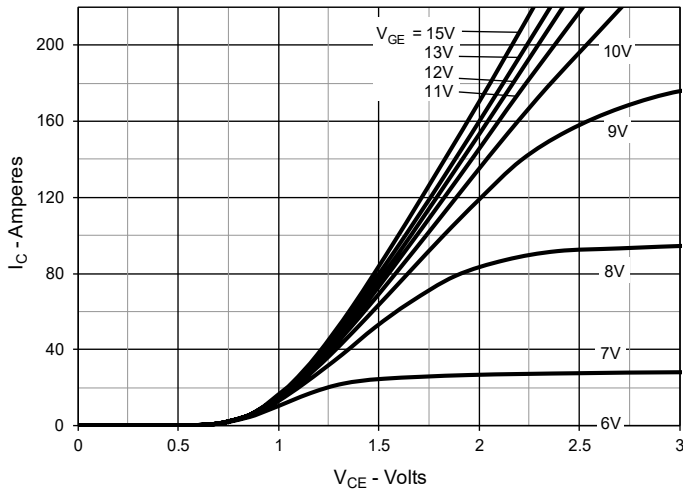
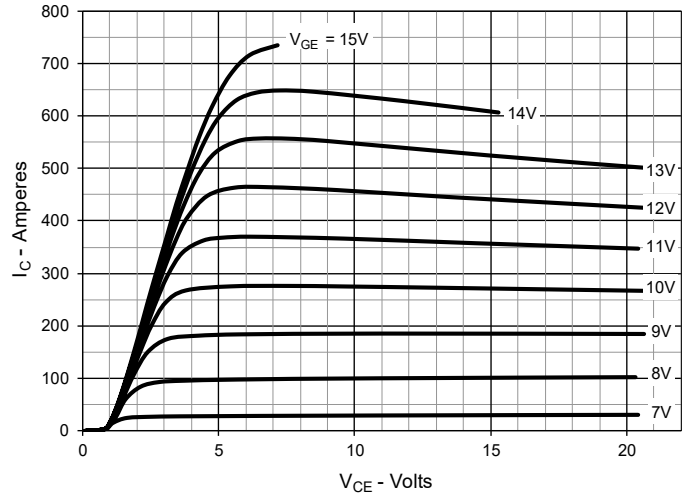
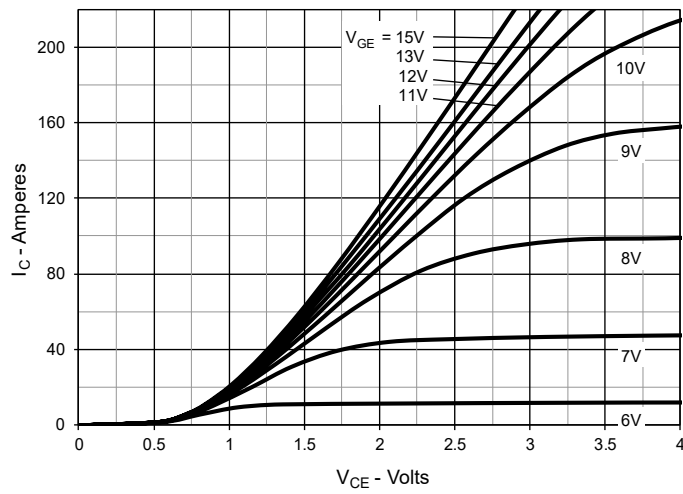
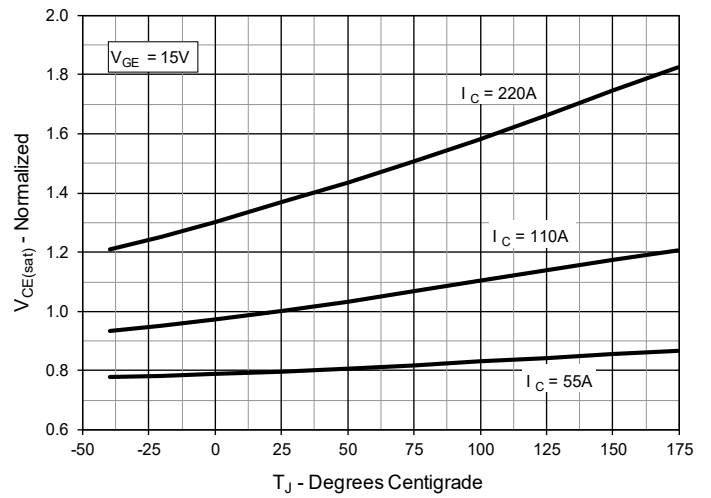
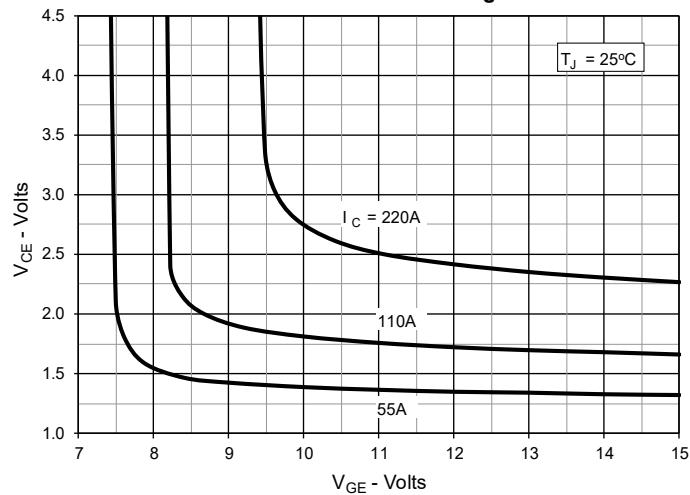
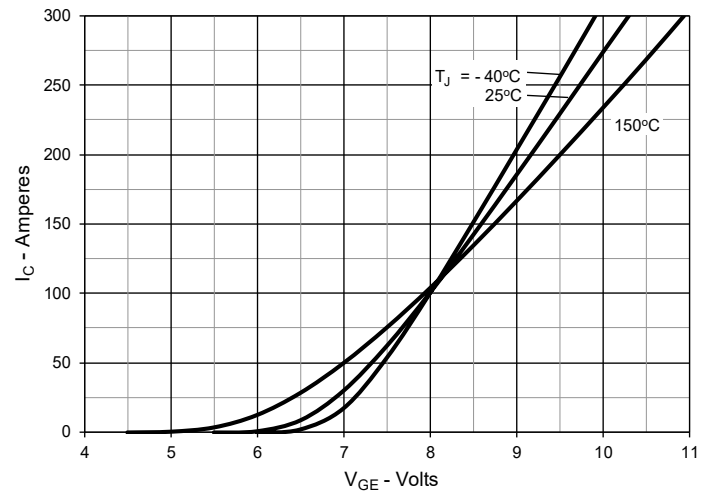
Fig. 6. Input Admittance

Fig. 7. Transconductance

Fig. 8. Gate Charge

Fig. 9. Capacitance

Fig. 10. Reverse-Bias Safe Operating Area

Fig. 11. Maximum Transient Thermal Impedance

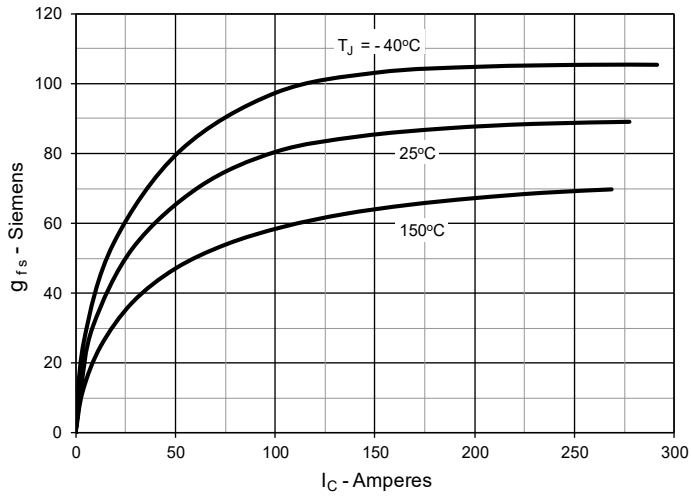
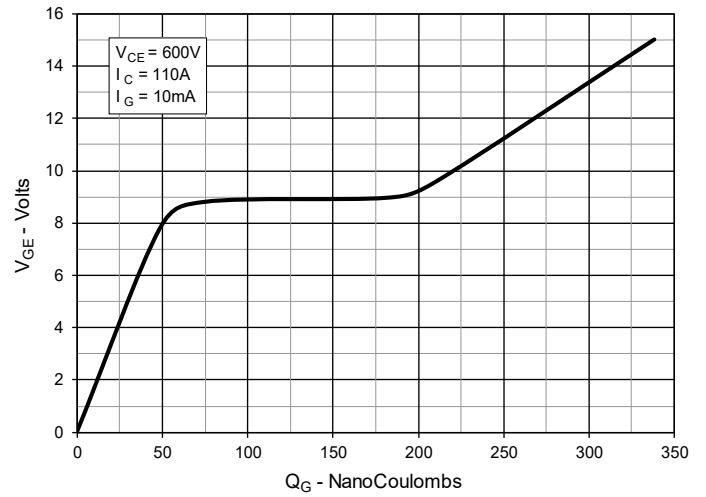
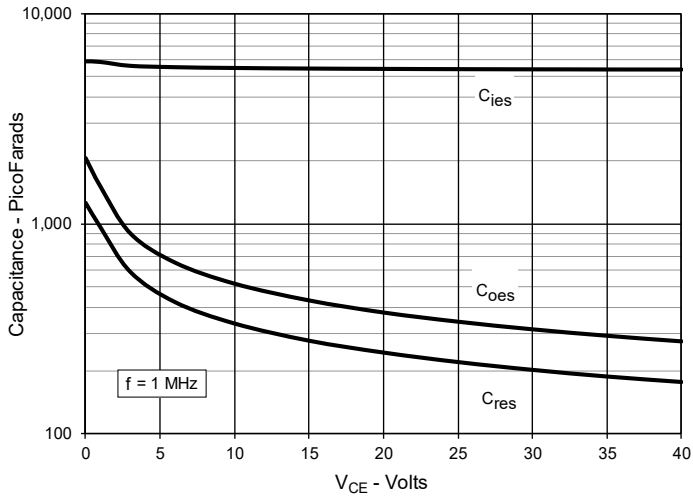
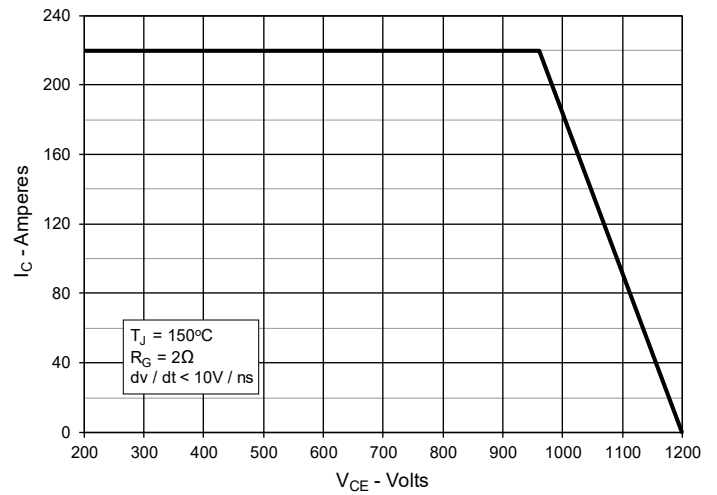
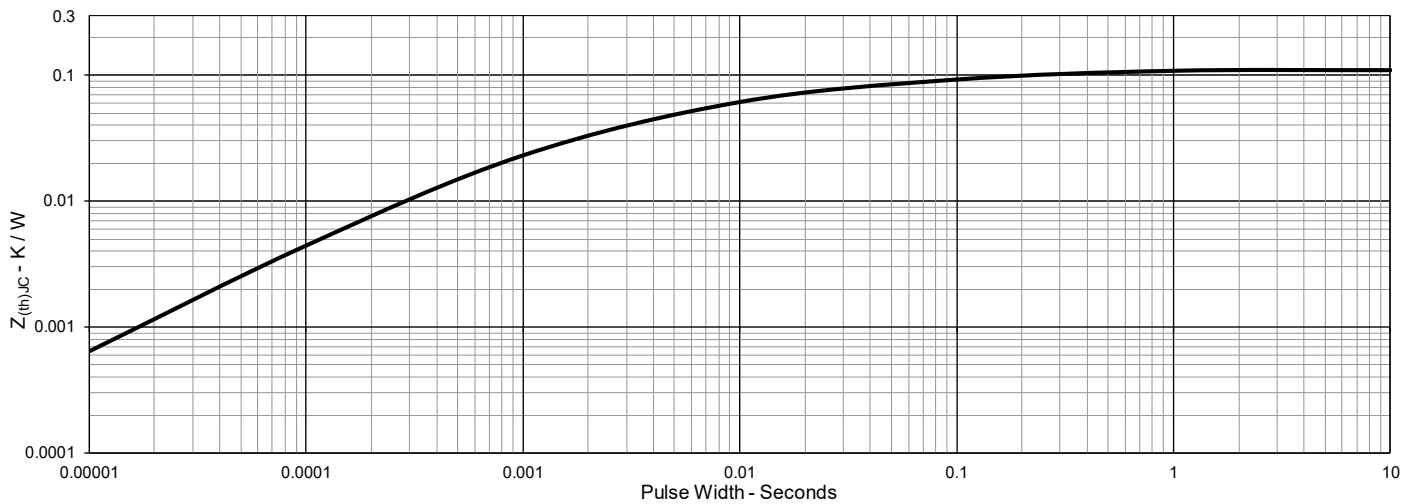
Fig. 12. Inductive Switching Energy Loss vs. Collector Current

Fig. 13. Inductive Switching Energy Loss vs. Collector-Emitter Voltage

Fig. 14. Inductive Switching Energy Loss vs. Gate Resistance

Fig. 15. Inductive Switching Energy Loss vs. Junction Temperature

Fig. 16. Inductive Turn-off Switching Times vs. Gate Resistance

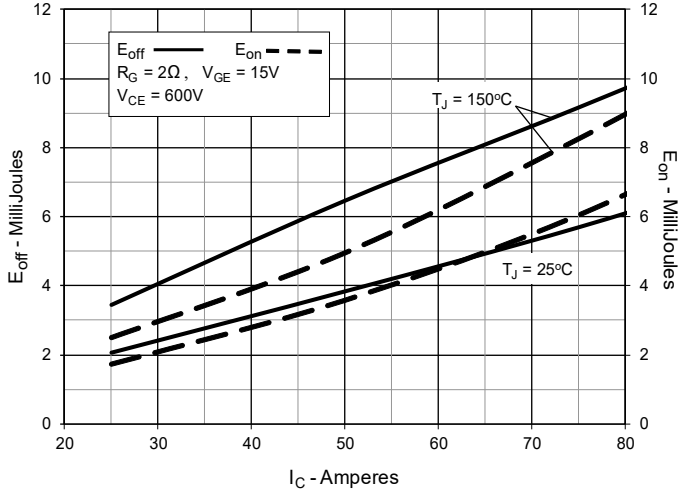
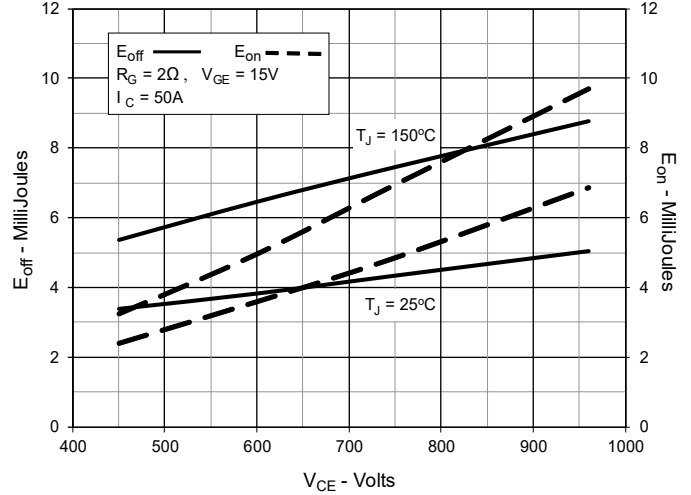
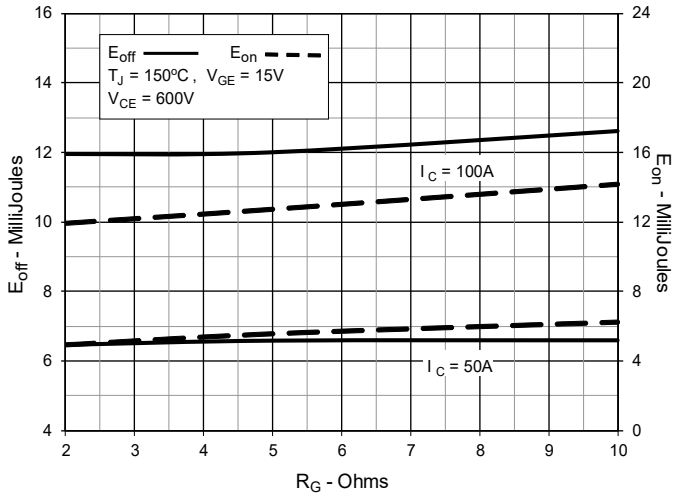
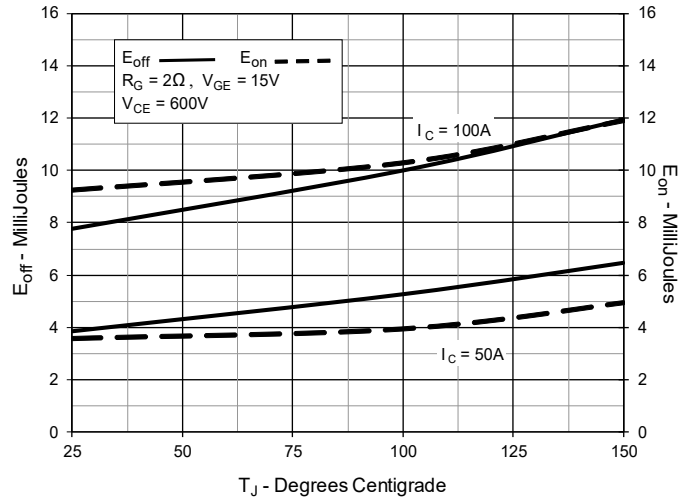
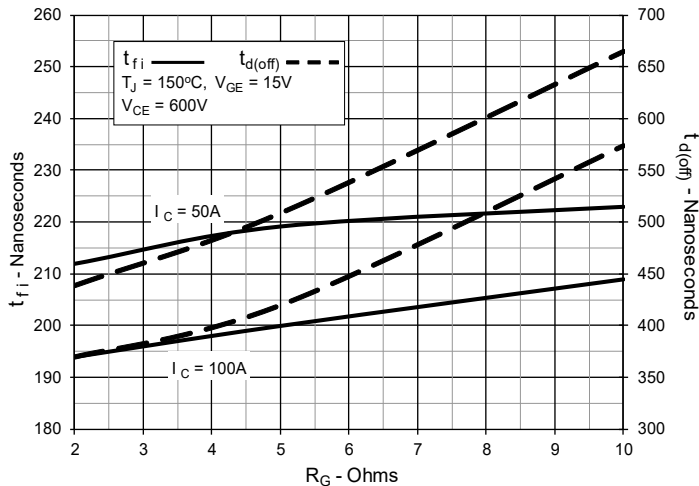
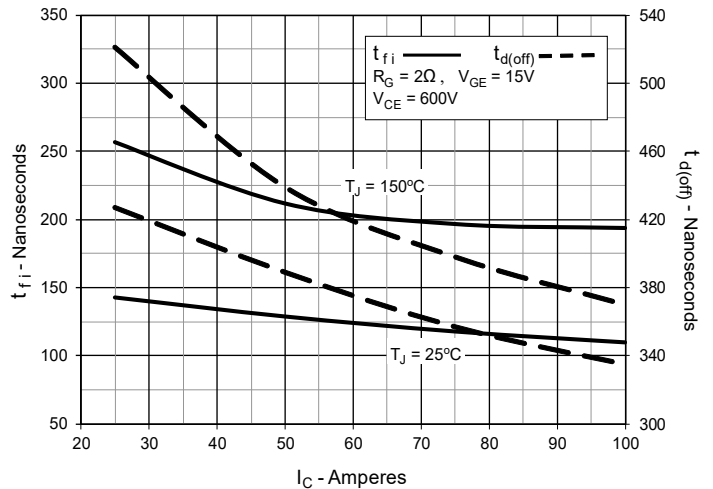
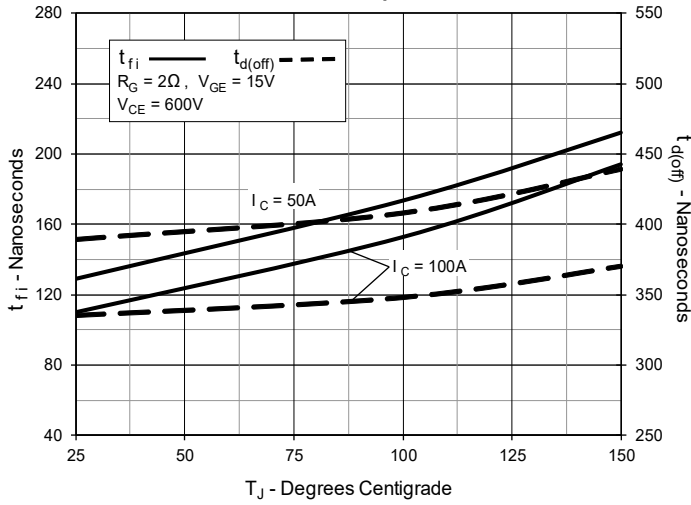
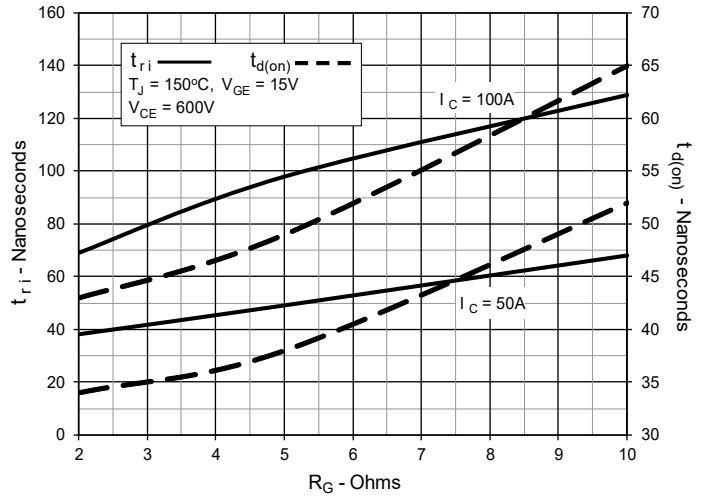
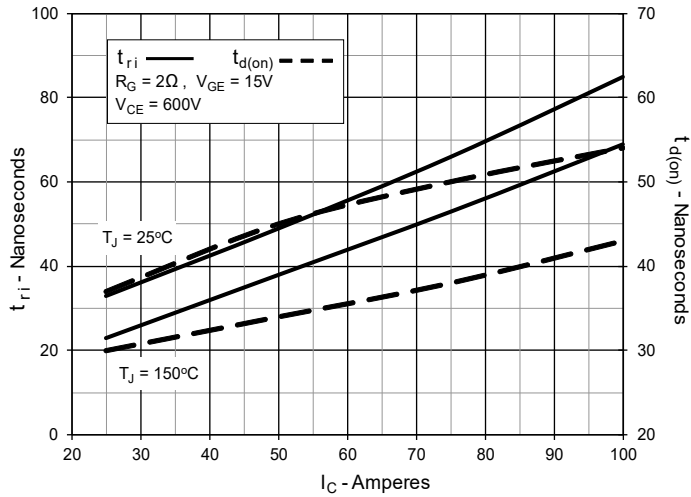
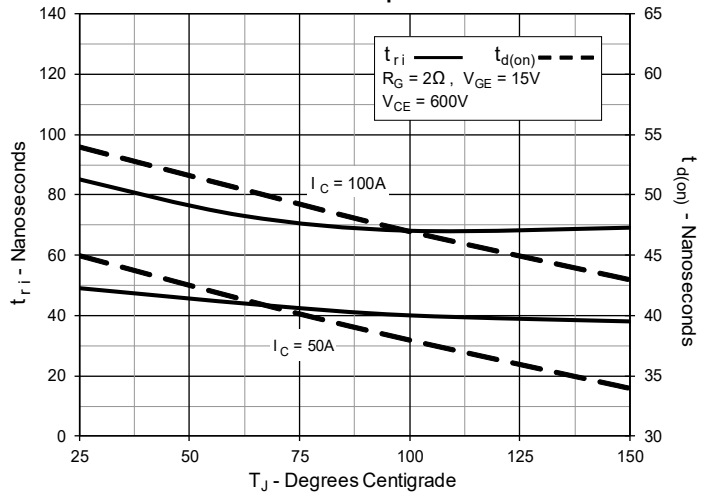
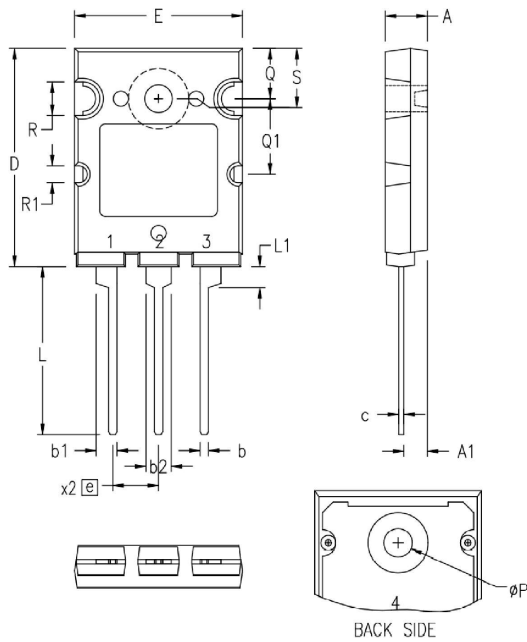
Fig. 17. Inductive Turn-off Switching Times vs. Collector Current

Fig. 18. Inductive Turn-off Switching Times vs. Junction Temperature

Fig. 19. Inductive Turn-on Switching Times vs. Gate Resistance

Fig. 20. Inductive Turn-on Switching Times vs. Collector Current

Fig. 21. Inductive Turn-on Switching Times vs. Junction Temperature

TO-264 Outline

- 1 - Gate**
- 2,4 - Collector**
- 3 - Emitter**

SYM	INCHES		MILLIMETERS	
	MIN	MAX	MIN	MAX
A	.185	.209	4.70	5.30
A1	.102	.118	2.60	3.00
b	.035	.049	0.90	1.25
b1	.091	.106	2.30	2.70
b2	.110	.126	2.80	3.20
c	.020	.033	0.50	0.85
D	1.012	1.035	25.70	26.30
E	.776	.799	19.70	20.30
e	.215BSC		5.46 BSC	
L	.768	.807	19.50	20.50
L1	.091	.106	2.30	2.70
øP	.122	.138	3.10	3.50
Q	.228	.244	5.80	6.20
Q1	.346	.362	8.80	9.20
øR	.150	.165	3.80	4.20
øR1	.071	.087	1.80	2.20
S	.228	.244	5.80	6.20