

November 1997

## 14A, 600V, UFS Series N-Channel IGBTs

### Features

- 14A, 600V,  $T_C = 25^\circ\text{C}$
- 600V Switching SOA Capability
- Typical Fall Time ..... 120ns at  $T_J = 150^\circ\text{C}$
- Short Circuit Rating
- Low Conduction Loss

### Ordering Information

PART NUMBER	PACKAGE	BRAND
HGTD7N60B3	TO-251AA	G7N60B
HGTD7N60B3S	TO-252AA	G7N60B
HGT1S7N60B3	TO-262AA	G7N60B3
HGT1S7N60B3S	TO-263AB	G7N60B3
HGTP7N60B3	TO-220AB	G7N60B3

NOTE: When ordering, use the entire part number. Add the suffix 9A to obtain the TO-252AA and TO-263AB variant in tape and reel, e.g., HGTD7N60B3S9A.

### Description

The HGTD7N60B3, HGTD7N60B3S, HGT1S7N60B3, HGT1S7N60B3S and HGTP7N60B3 are MOS gated high voltage switching devices combining the best features of MOS-FETs and bipolar transistors. These devices have the high input impedance of a MOSFET and the low on-state conduction loss of a bipolar transistor. The much lower on-state voltage drop varies only moderately between  $25^\circ\text{C}$  and  $150^\circ\text{C}$ .

The IGBT is ideal for many high voltage switching applications operating at moderate frequencies where low conduction losses are essential, such as: AC and DC motor controls, power supplies and drivers for solenoids, relays and contactors.

Formerly Developmental Type TA49190.

### Symbol

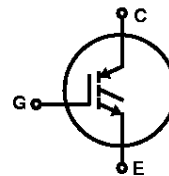

### Packaging

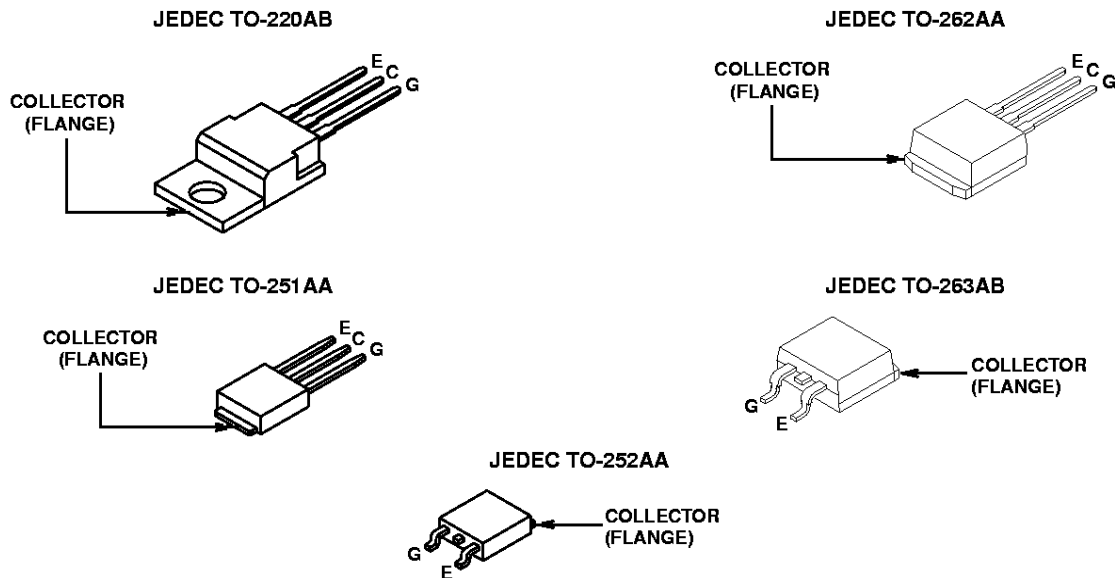

HARRIS SEMICONDUCTOR IGBT PRODUCT IS COVERED BY ONE OR MORE OF THE FOLLOWING U.S. PATENTS

4,364,073	4,417,385	4,430,792	4,443,931	4,466,176	4,516,143	4,532,534	4,567,641
4,587,713	4,598,461	4,605,948	4,618,872	4,620,211	4,631,564	4,639,754	4,639,762
4,641,162	4,644,637	4,682,195	4,684,413	4,694,313	4,717,679	4,743,952	4,783,690
4,794,432	4,801,986	4,803,533	4,809,045	4,809,047	4,810,665	4,823,176	4,837,606
4,860,080	4,883,767	4,888,627	4,890,143	4,901,127	4,904,609	4,933,740	4,963,951
4,969,027							

# HGTD7N60B3, HGTD7N60B3S, HGT1S7N60B3, HGT1S7N60B3S, HGTP7N60B3

## Absolute Maximum Ratings $T_C = 25^\circ\text{C}$ , Unless Otherwise Specified

	ALL TYPES	UNITS
Collector to Emitter Voltage	600	V
Collector Current Continuous		
At $T_C = 25^\circ\text{C}$	14	A
At $T_C = 110^\circ\text{C}$	7	A
Collector Current Pulsed (Note 1)	56	A
Gate to Emitter Voltage Continuous	$\pm 20$	V
Gate to Emitter Voltage Pulsed	$\pm 30$	V
Switching Safe Operating Area at $T_J = 150^\circ\text{C}$ , Figure 2	35A at 600V	
Power Dissipation Total at $T_C = 25^\circ\text{C}$	60	W
Power Dissipation Derating $T_C > 25^\circ\text{C}$	0.476	W/ $^\circ\text{C}$
Reverse Voltage Avalanche Energy	100	mJ
Operating and Storage Junction Temperature Range	-55 to 150	$^\circ\text{C}$
Maximum Lead Temperature for Soldering	260	$^\circ\text{C}$
Short Circuit Withstand Time (Note 2) at $V_{GE} = 15\text{V}$	2	$\mu\text{s}$
Short Circuit Withstand Time (Note 2) at $V_{GE} = 10\text{V}$	12	$\mu\text{s}$

CAUTION: Stresses above those listed in "Absolute Maximum Ratings" may cause permanent damage to the device. This is a stress only rating and operation of the device at these or any other conditions above those indicated in the operational sections of this specification is not implied.

### NOTES:

1. Single Pulse; Pulse width limited by maximum junction temperature. Parts may current limit at less than  $I_{CM}$ .
2.  $V_{CE} = 360\text{V}$ ,  $T_J = 125^\circ\text{C}$ ,  $R_{GE} = 50\Omega$ .

## Electrical Specifications $T_C = 25^\circ\text{C}$ , Unless Otherwise Specified

PARAMETERS	SYMBOL	TEST CONDITIONS	MIN	TYP	MAX	UNITS	
Collector to Emitter Breakdown Voltage	$BV_{CES}$	$I_C = 250\mu\text{A}$ , $V_{GE} = 0\text{V}$	600	-	-	V	
Emitter to Collector Breakdown Voltage	$BV_{ECS}$	$I_C = 3\text{mA}$ , $V_{GE} = 0\text{V}$	15	28	-	V	
Collector to Emitter Leakage Current	$I_{CES}$	$V_{CE} = BV_{CES}$	$T_C = 25^\circ\text{C}$	-	-	100	$\mu\text{A}$
			$T_C = 150^\circ\text{C}$	-	-	2.0	mA
Collector to Emitter Saturation Voltage	$V_{CE(SAT)}$	$I_C = I_{C110}$ , $V_{GE} = 15\text{V}$	$T_C = 25^\circ\text{C}$	-	1.8	2.1	V
			$T_C = 150^\circ\text{C}$	-	2.1	2.4	V
Gate to Emitter Threshold Voltage	$V_{GE(TH)}$	$I_C = 250\mu\text{A}$ , $V_{CE} = V_{GE}$	3.0	5.1	6.0	V	
Gate to Emitter Leakage Current	$I_{GES}$	$V_{GE} = \pm 20\text{V}$	-	-	$\pm 100$	nA	
Switching SOA	SSOA	$T_J = 150^\circ\text{C}$ $R_G = 50\Omega$ $V_{GE} = 15\text{V}$ $L = 100\text{H}$	$V_{CE} = 480\text{V}$	42	-	-	A
			$V_{CE} = 600\text{V}$	35	-	-	A
Gate to Emitter Plateau Voltage	$V_{GEP}$	$I_C = I_{C110}$ , $V_{CE} = 0.5 BV_{CES}$	-	7.7	-	V	
On-State Gate Charge	$Q_{G(ON)}$	$I_C = I_{C110}$ , $V_{CE} = 0.5 BV_{CES}$	$V_{GE} = 15\text{V}$	-	23	28	nC
			$V_{GE} = 20\text{V}$	-	30	37	nC

# HGTD7N60B3, HGTD7N60B3S, HGT1S7N60B3, HGT1S7N60B3S, HGTP7N60B3

## Electrical Specifications $T_C = 25^\circ\text{C}$ , Unless Otherwise Specified (Continued)

PARAMETERS	SYMBOL	TEST CONDITIONS	MIN	TYP	MAX	UNITS
Current Turn-On Delay Time	$t_{d(ON)}$	IGBT and Diode Both at $T_J = 25^\circ\text{C}$ $I_{CE} = I_{C110}$ , $V_{CE} = 0.8 V_{CES}$ , $V_{GE} = 15\text{V}$ , $R_G = 50\Omega$ , $L = 2\text{mH}$ Test Circuit (Figure 17)	-	26	-	ns
Current Rise Time	$t_{r1}$		-	21	-	ns
Current Turn-Off Delay Time	$t_{d(OFF)}$		-	130	160	ns
Current Fall Time	$t_{f1}$		-	60	80	ns
Turn-On Energy (Note 4)	$E_{ON1}$		-	72	-	$\mu\text{J}$
Turn-On Energy (Note 4)	$E_{ON2}$		-	160	200	$\mu\text{J}$
Turn-Off Energy (Note 3)	$E_{OFF}$		-	120	200	$\mu\text{J}$
Current Turn-On Delay Time	$t_{d(ON)}$	IGBT and Diode Both at $T_J = 150^\circ\text{C}$ $I_{CE} = I_{C110}$ , $V_{CE} = 0.8 V_{CES}$ , $V_{GE} = 15\text{V}$ , $R_G = 50\Omega$ , $L = 2\text{mH}$ Test Circuit (Figure 17)	-	24	-	ns
Current Rise Time	$t_{r1}$		-	22	-	ns
Current Turn-Off Delay Time	$t_{d(OFF)}$		-	230	295	ns
Current Fall Time	$t_{f1}$		-	120	175	ns
Turn-On Energy (Note 4)	$E_{ON1}$		-	80	-	$\mu\text{J}$
Turn-On Energy (Note 4)	$E_{ON2}$		-	310	350	$\mu\text{J}$
Turn-Off Energy (Note 3)	$E_{OFF}$		-	350	500	$\mu\text{J}$
Thermal Resistance Junction To Case	$R_{\theta JC}$		-	-	2.1	$^\circ\text{C}/\text{W}$

### NOTE:

- Turn-Off Energy Loss ( $E_{OFF}$ ) is defined as the integral of the instantaneous power loss starting at the trailing edge of the input pulse and ending at the point where the collector current equals zero ( $I_{CE} = 0\text{A}$ ). All devices were tested per JEDEC standard No. 24-1 Method for Measurement of Power Device Turn-Off Switching Loss. This test method produces the true total Turn-Off Energy Loss. Turn-On losses include losses due to diode recovery.
- Values for two Turn-On loss conditions are shown for the convenience of the circuit designer.  $E_{ON1}$  is the Turn-On loss of the IGBT only.  $E_{ON2}$  is the Turn-On loss when a typical diode is used in the test circuit and the diode is at the same  $T_J$  as the IGBT. The diode type is specified in Figure 17.

## Typical Performance Curves (Unless Otherwise Specified)

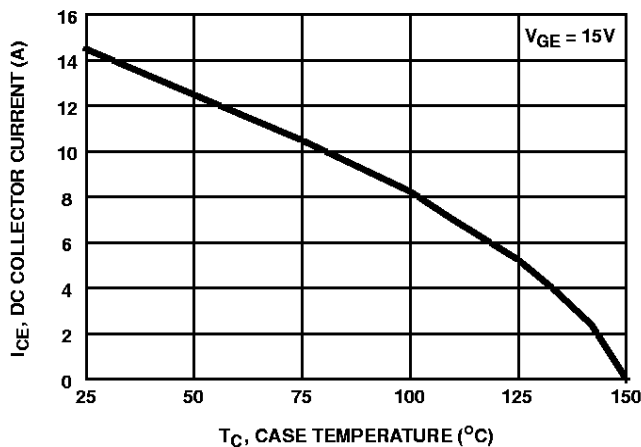

FIGURE 1. DC COLLECTOR CURRENT AS A FUNCTION OF CASE TEMPERATURE

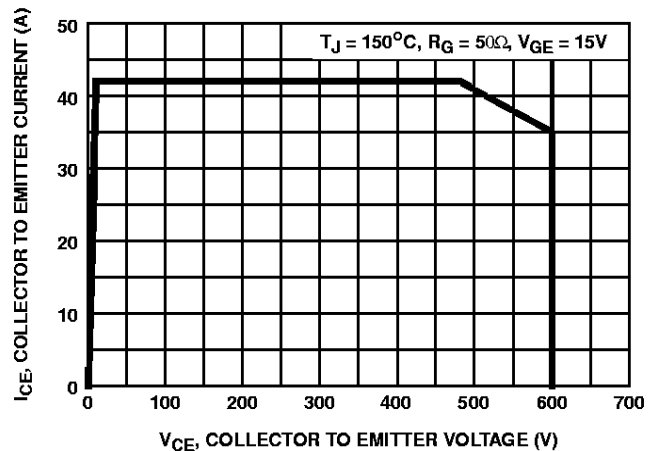

FIGURE 2. MINIMUM SWITCHING SAFE OPERATING AREA

Typical Performance Curves (Unless Otherwise Specified) (Continued)

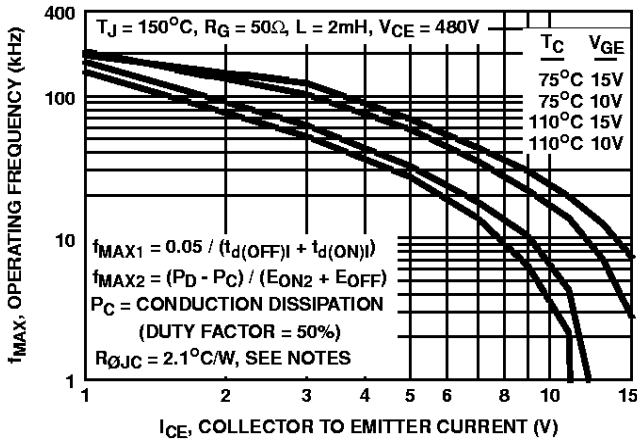

FIGURE 3. OPERATING FREQUENCY AS A FUNCTION OF COLLECTOR TO EMITTER CURRENT

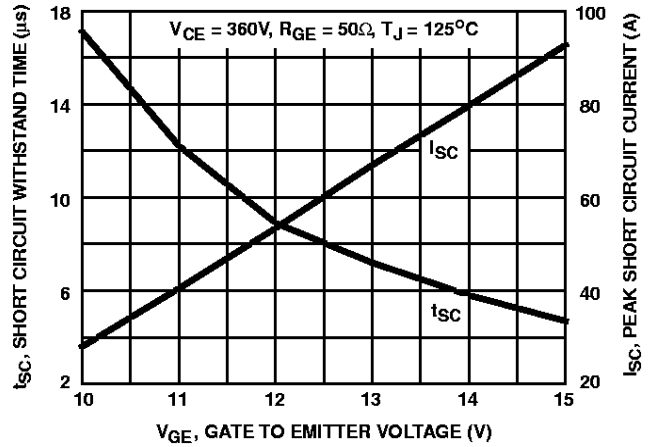

FIGURE 4. SHORT CIRCUIT WITHSTAND TIME

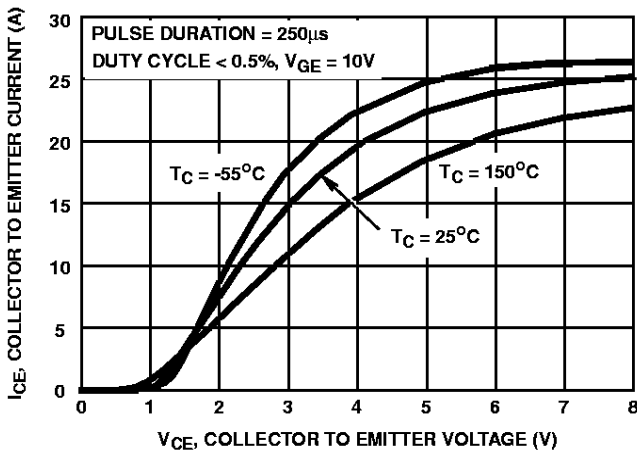

FIGURE 5. COLLECTOR TO EMITTER ON STATE VOLTAGE

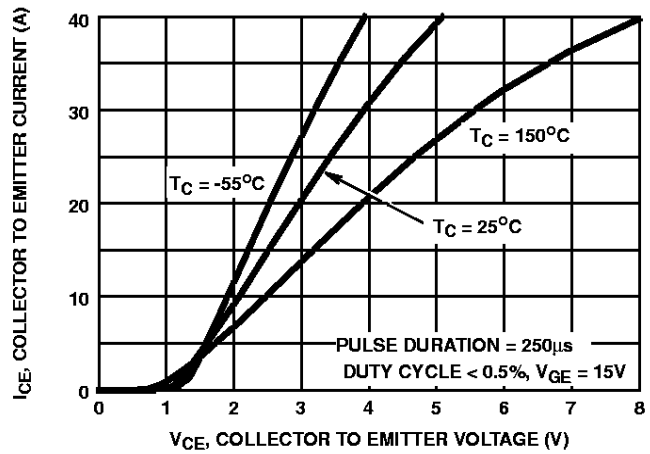

FIGURE 6. COLLECTOR TO EMITTER ON STATE VOLTAGE

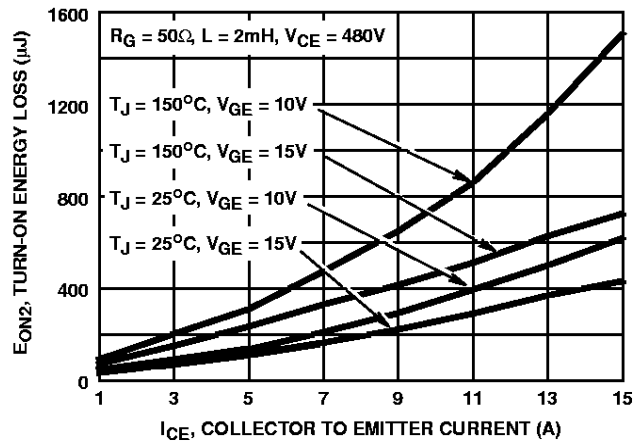

FIGURE 7. TURN-ON ENERGY LOSS AS A FUNCTION OF COLLECTOR TO EMITTER CURRENT

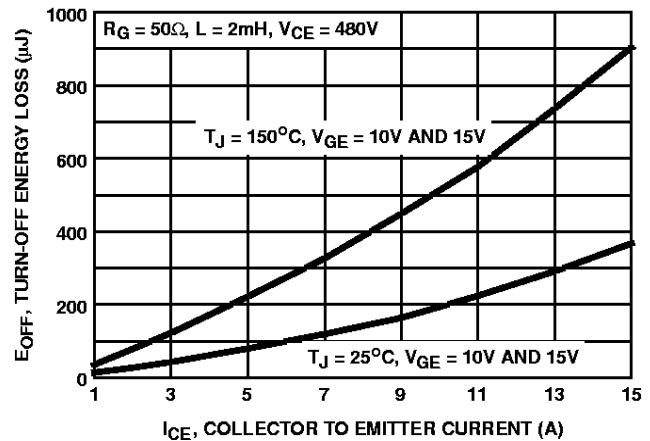

FIGURE 8. TURN-OFF ENERGY LOSS AS A FUNCTION OF COLLECTOR TO EMITTER CURRENT

Typical Performance Curves (Unless Otherwise Specified) (Continued)

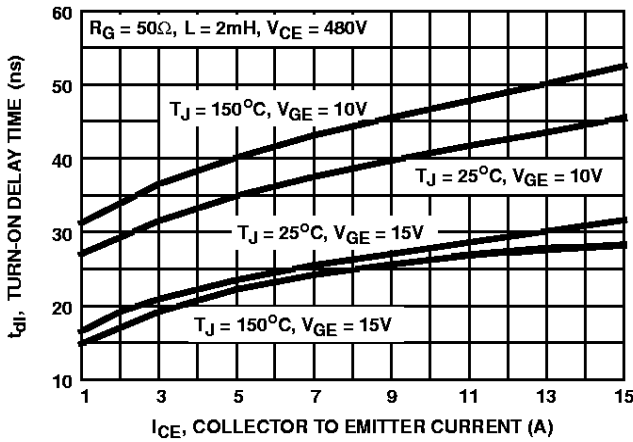

FIGURE 9. TURN-ON DELAY TIME AS A FUNCTION OF COLLECTOR TO EMITTER CURRENT

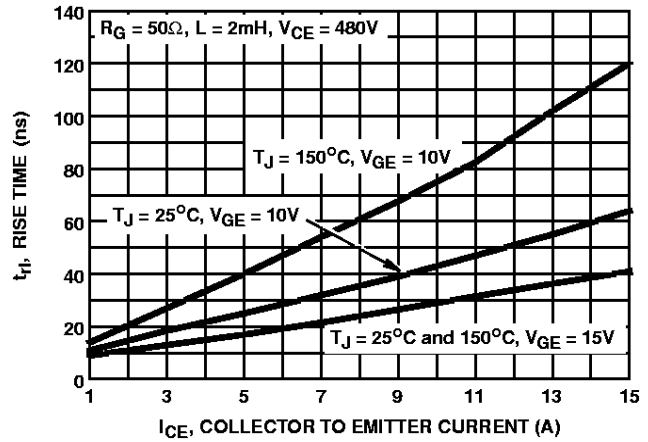

FIGURE 10. TURN-ON RISE TIME AS A FUNCTION OF COLLECTOR TO EMITTER CURRENT

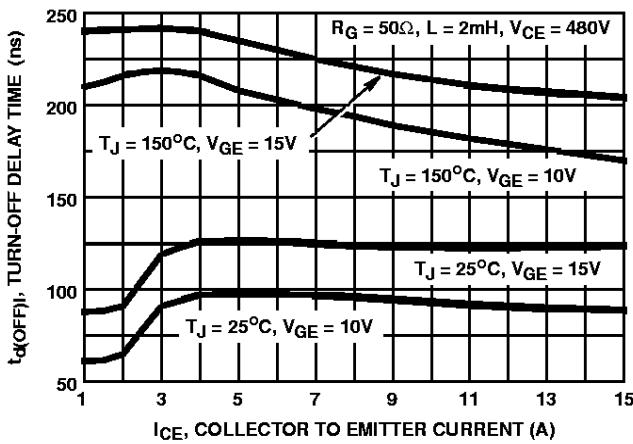

FIGURE 11. TURN-OFF DELAY TIME AS A FUNCTION OF COLLECTOR TO EMITTER CURRENT

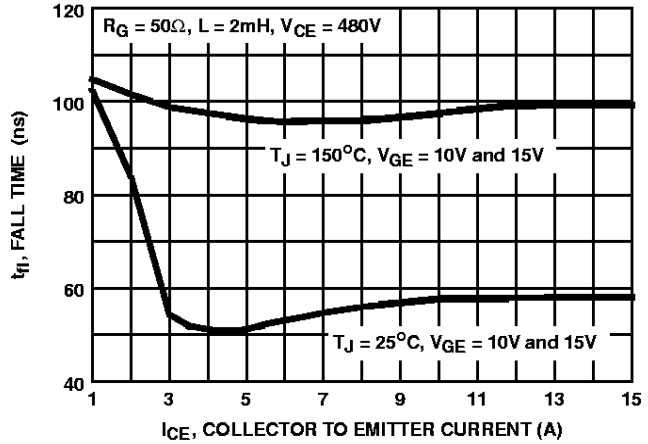

FIGURE 12. FALL TIME AS A FUNCTION OF COLLECTOR TO EMITTER CURRENT

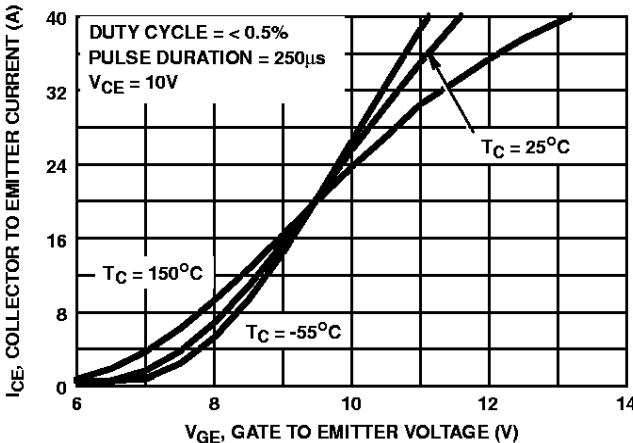

FIGURE 13. TRANSFER CHARACTERISTIC

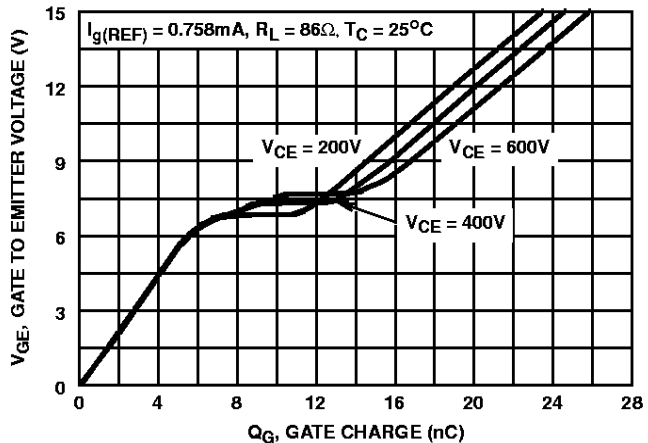

FIGURE 14. GATE CHARGE WAVEFORMS

Typical Performance Curves (Unless Otherwise Specified) (Continued)

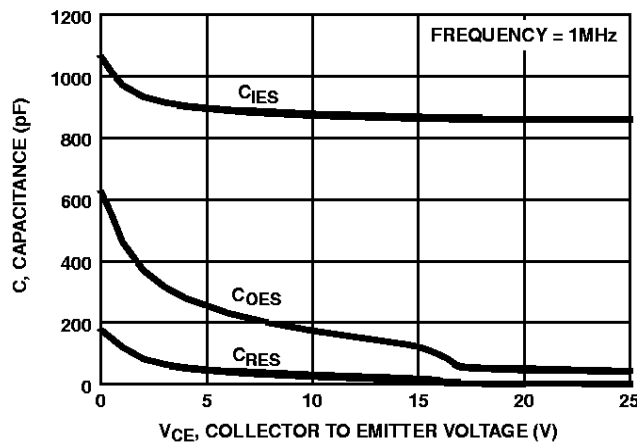

FIGURE 15. CAPACITANCE AS A FUNCTION OF COLLECTOR TO EMITTER VOLTAGE

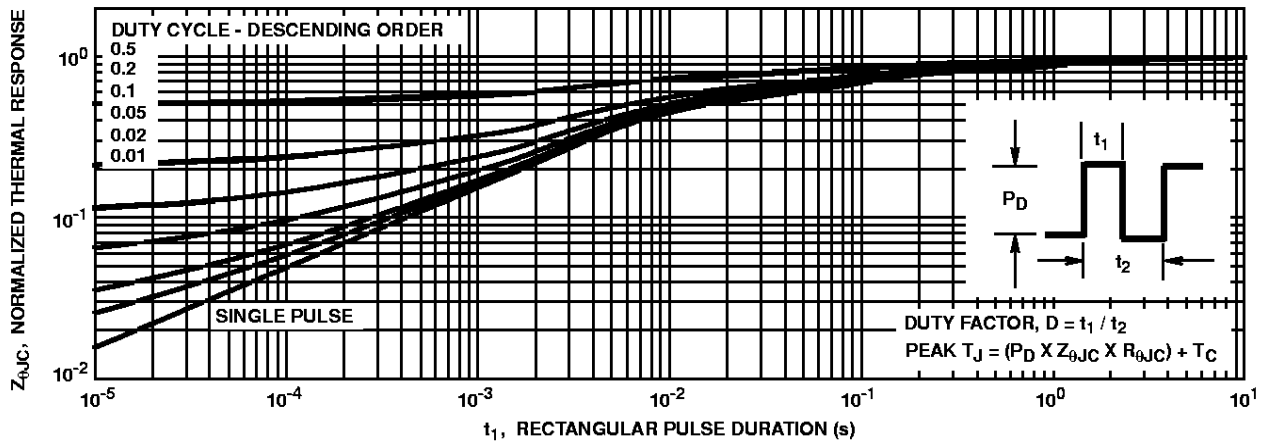

FIGURE 16. NORMALIZED TRANSIENT THERMAL RESPONSE, JUNCTION TO CASE

Test Circuit and Waveforms

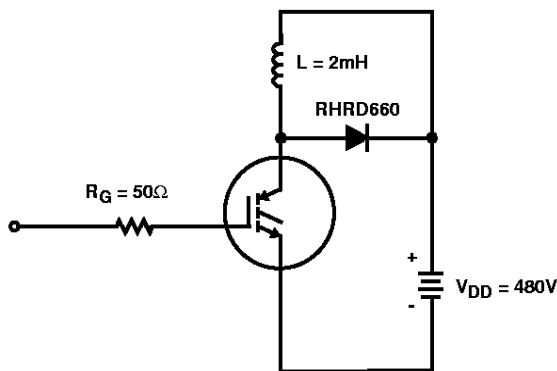

FIGURE 17. INDUCTIVE SWITCHING TEST CIRCUIT

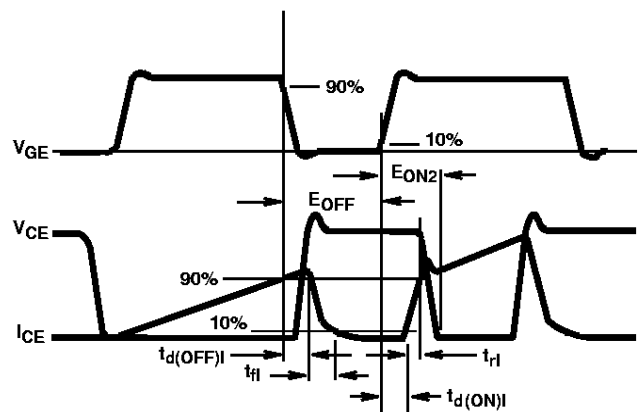

FIGURE 18. SWITCHING TEST WAVEFORMS

### Handling Precautions for IGBTs

Insulated Gate Bipolar Transistors are susceptible to gate-insulation damage by the electrostatic discharge of energy through the devices. When handling these devices, care should be exercised to assure that the static charge built in the handler's body capacitance is not discharged through the device. With proper handling and application procedures, however, IGBTs are currently being extensively used in production by numerous equipment manufacturers in military, industrial and consumer applications, with virtually no damage problems due to electrostatic discharge. IGBTs can be handled safely if the following basic precautions are taken:

1. Prior to assembly into a circuit, all leads should be kept shorted together either by the use of metal shorting springs or by the insertion into conductive material such as "ECCOSORBD™ LD26" or equivalent.
2. When devices are removed by hand from their carriers, the hand being used should be grounded by any suitable means - for example, with a metallic wristband.
3. Tips of soldering irons should be grounded.
4. Devices should never be inserted into or removed from circuits with power on.
5. **Gate Voltage Rating** - Never exceed the gate-voltage rating of  $V_{GEM}$ . Exceeding the rated  $V_{GE}$  can result in permanent damage to the oxide layer in the gate region.
6. **Gate Termination** - The gates of these devices are essentially capacitors. Circuits that leave the gate open-circuited or floating should be avoided. These conditions can result in turn-on of the device due to voltage buildup on the input capacitor due to leakage currents or pickup.
7. **Gate Protection** - These devices do not have an internal monolithic Zener diode from gate to emitter. If gate protection is required an external Zener is recommended.

### Operating Frequency Information

Operating frequency information for a typical device (Figure 3) is presented as a guide for estimating device performance for a specific application. Other typical frequency vs collector current ( $I_{CE}$ ) plots are possible using the information shown for a typical unit in Figures 5, 6, 7, 8, 9 and 11. The operating frequency plot (Figure 3) of a typical device shows  $f_{MAX1}$  or  $f_{MAX2}$ ; whichever is smaller at each point. The information is based on measurements of a typical device and is bounded by the maximum rated junction temperature.

$f_{MAX1}$  is defined by  $f_{MAX1} = 0.05/(t_{d(OFF)} + t_{d(ON)})$ . Dead-time (the denominator) has been arbitrarily held to 10% of the on-state time for a 50% duty factor. Other definitions are possible.  $t_{d(OFF)}$  and  $t_{d(ON)}$  are defined in Figure 18. Device turn-off delay can establish an additional frequency limiting condition for an application other than  $T_{JMAX}$ .  $t_{d(OFF)}$  is important when controlling output ripple under a lightly loaded condition.

$f_{MAX2}$  is defined by  $f_{MAX2} = (P_D - P_C)/(E_{OFF} + E_{ON2})$ . The allowable dissipation ( $P_D$ ) is defined by  $P_D = (T_{JMAX} - T_C)/R_{\theta JC}$ . The sum of device switching and conduction losses must not exceed  $P_D$ . A 50% duty factor was used (Figure 3) and the conduction losses ( $P_C$ ) are approximated by  $P_C = (V_{CE} \times I_{CE})/2$ .

$E_{ON2}$  and  $E_{OFF}$  are defined in the switching waveforms shown in Figure 18.  $E_{ON2}$  is the integral of the instantaneous power loss ( $I_{CE} \times V_{CE}$ ) during turn-on and  $E_{OFF}$  is the integral of the instantaneous power loss ( $I_{CE} \times V_{CE}$ ) during turn-off. All tail losses are included in the calculation for  $E_{OFF}$ ; i.e., the collector current equals zero ( $I_{CE} = 0$ ).

HGTD7N60B3, HGTD7N60B3S, HGT1S7N60B3, HGT1S7N60B3S, HGTP7N60B3

**TO-251AA**

3 LEAD JEDEC TO-251AA PLASTIC PACKAGE

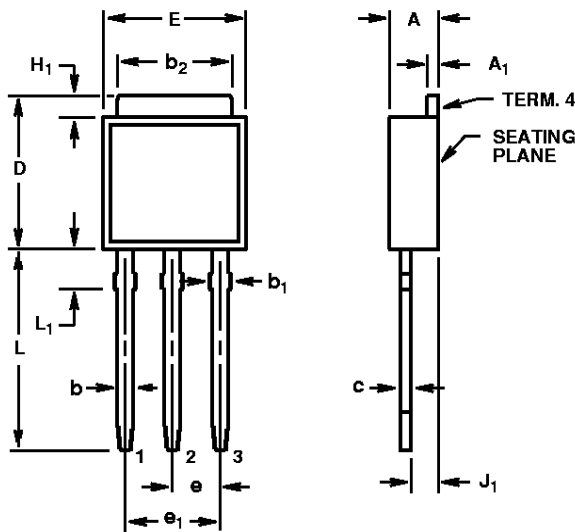

SYMBOL	INCHES		MILLIMETERS		NOTES
	MIN	MAX	MIN	MAX	
A	0.086	0.094	2.19	2.38	-
A <sub>1</sub>	0.018	0.022	0.46	0.55	3, 4
b	0.028	0.032	0.72	0.81	3, 4
b <sub>1</sub>	0.033	0.040	0.84	1.01	3
b <sub>2</sub>	0.205	0.215	5.21	5.46	3, 4
c	0.018	0.022	0.46	0.55	3, 4
D	0.270	0.290	6.86	7.36	-
E	0.250	0.265	6.35	6.73	-
e	0.090 TYP		2.28 TYP		5
e <sub>1</sub>	0.180 BSC		4.57 BSC		5
H <sub>1</sub>	0.035	0.045	0.89	1.14	-
J <sub>1</sub>	0.040	0.045	1.02	1.14	6
L	0.355	0.375	9.02	9.52	-
L <sub>1</sub>	0.075	0.090	1.91	2.28	2

NOTES:

1. These dimensions are within allowable dimensions of Rev. C of JEDEC TO-251AA outline dated 9-88.
2. Solder finish uncontrolled in this area.
3. Dimension (without solder).
4. Add typically 0.002 inches (0.05mm) for solder plating.
5. Position of lead to be measured 0.250 inches (6.35mm) from bottom of dimension D.
6. Position of lead to be measured 0.100 inches (2.54mm) from bottom of dimension D.
7. Controlling dimension: Inch.
8. Revision 2 dated 10-95.

**TO-252AA**

SURFACE MOUNT JEDEC TO-252AA PLASTIC PACKAGE

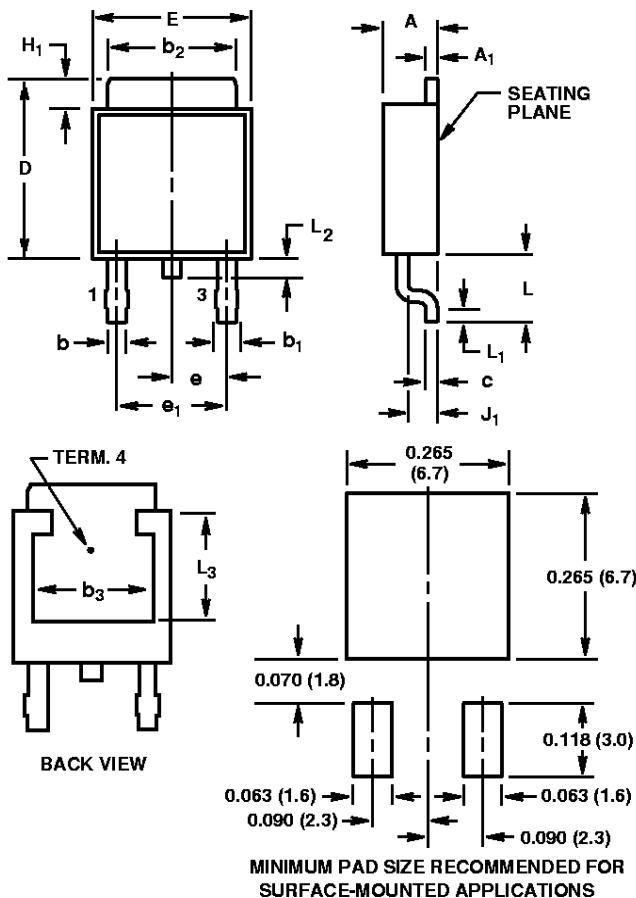

SYMBOL	INCHES		MILLIMETERS		NOTES
	MIN	MAX	MIN	MAX	
A	0.086	0.094	2.19	2.38	-
A <sub>1</sub>	0.018	0.022	0.46	0.55	4, 5
b	0.028	0.032	0.72	0.81	4, 5
b <sub>1</sub>	0.033	0.040	0.84	1.01	4
b <sub>2</sub>	0.205	0.215	5.21	5.46	4, 5
b <sub>3</sub>	0.190	-	4.83	-	2
c	0.018	0.022	0.46	0.55	4, 5
D	0.270	0.290	6.86	7.36	-
E	0.250	0.265	6.35	6.73	-
e	0.090 TYP		2.28 TYP		7
e <sub>1</sub>	0.180 BSC		4.57 BSC		7
H <sub>1</sub>	0.035	0.045	0.89	1.14	-
J <sub>1</sub>	0.040	0.045	1.02	1.14	-
L	0.100	0.115	2.54	2.92	-
L <sub>1</sub>	0.020	-	0.51	-	4, 6
L <sub>2</sub>	0.025	0.040	0.64	1.01	3
L <sub>3</sub>	0.170	-	4.32	-	2

NOTES:

1. These dimensions are within allowable dimensions of Rev. B of JEDEC TO-252AA outline dated 9-88.
2. L<sub>3</sub> and b<sub>3</sub> dimensions establish a minimum mounting surface for terminal 4.
3. Solder finish uncontrolled in this area.
4. Dimension (without solder).
5. Add typically 0.002 inches (0.05mm) for solder plating.
6. L<sub>1</sub> is the terminal length for soldering.
7. Position of lead to be measured 0.090 inches (2.28mm) from bottom of dimension D.
8. Controlling dimension: Inch.
9. Revision 7 dated 7-97.



**TO-252AA**

16mm TAPE AND REEL

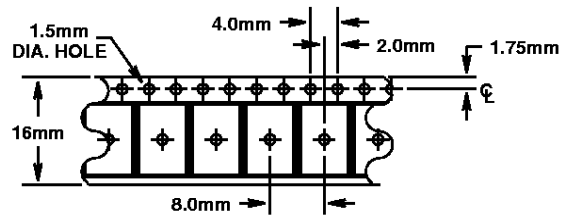
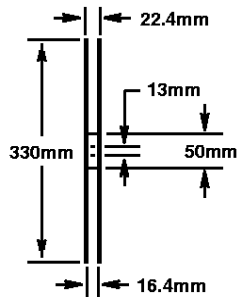
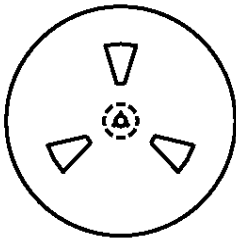

USER DIRECTION OF FEED

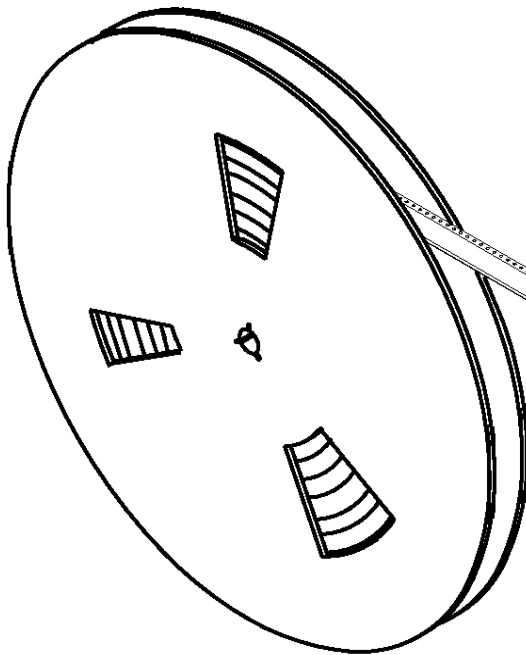
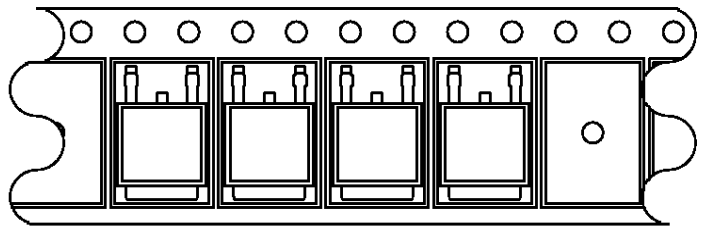

COVER TAPE

**GENERAL INFORMATION**

1. USE "9A" SUFFIX ON PART NUMBER.  
USE "T" SUFFIX ON PART FOR "HUF" SERIES.
2. 2500 PIECES PER REEL.
3. ORDER IN MULTIPLES OF FULL REELS ONLY.
4. MEETS EIA-481 REVISION "A" SPECIFICATIONS.

Revision 7 dated 7-97

HGTD7N60B3, HGTD7N60B3S, HGT1S7N60B3, HGT1S7N60B3S, HGTP7N60B3

**TO-262AA** 3 LEAD JEDEC TO-262AA PLASTIC PACKAGE

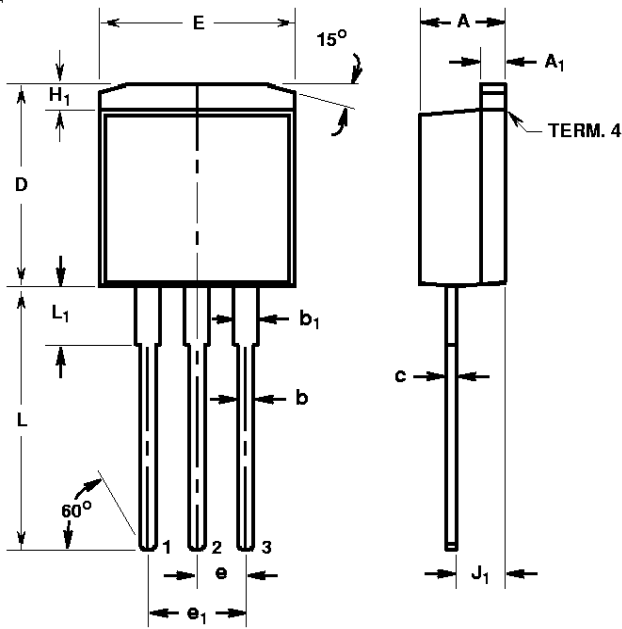

SYMBOL	INCHES		MILLIMETERS		NOTES
	MIN	MAX	MIN	MAX	
A	0.170	0.180	4.32	4.57	-
A <sub>1</sub>	0.048	0.052	1.22	1.32	3, 4
b	0.030	0.034	0.77	0.86	3, 4
b <sub>1</sub>	0.045	0.055	1.15	1.39	3, 4
c	0.018	0.022	0.46	0.55	3, 4
D	0.405	0.425	10.29	10.79	-
E	0.395	0.405	10.04	10.28	-
e	0.100 TYP		2.54 TYP		5
e <sub>1</sub>	0.200 BSC		5.08 BSC		5
H <sub>1</sub>	0.045	0.055	1.15	1.39	-
J <sub>1</sub>	0.095	0.105	2.42	2.66	6
L	0.530	0.550	13.47	13.97	-
L <sub>1</sub>	0.110	0.130	2.80	3.30	2

NOTES:

1. These dimensions are within allowable dimensions of Rev. A of JEDEC TO-262AA outline dated 6-90.
2. Solder finish uncontrolled in this area.
3. Dimension (without solder).
4. Add typically 0.002 inches (0.05mm) for solder plating.
5. Position of lead to be measured 0.250 inches (6.35mm) from bottom of dimension D.
6. Position of lead to be measured 0.100 inches (2.54mm) from bottom of dimension D.
7. Controlling dimension: Inch.
8. Revision 5 dated 7-97.

**TO-263AB** SURFACE MOUNT JEDEC TO-263AB PLASTIC PACKAGE

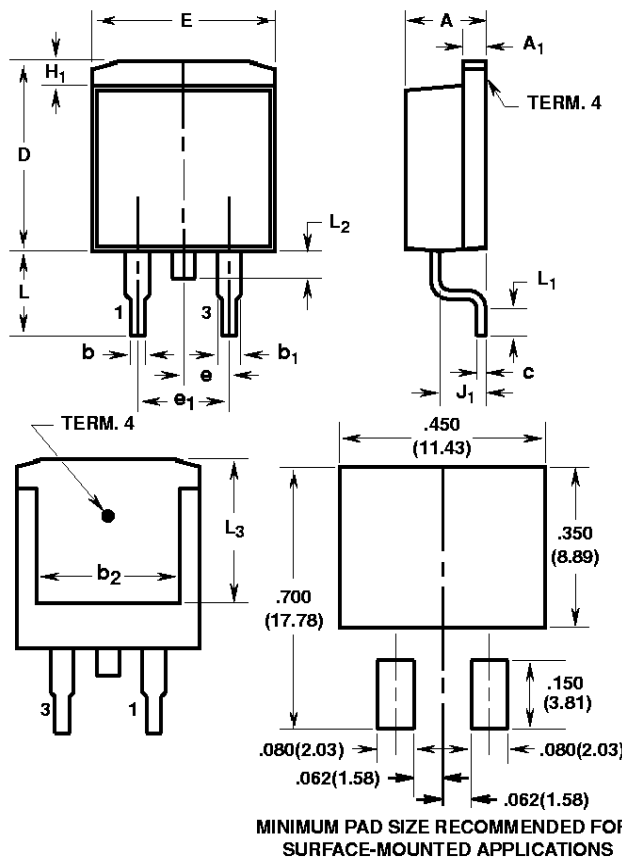

SYMBOL	INCHES		MILLIMETERS		NOTES
	MIN	MAX	MIN	MAX	
A	0.170	0.180	4.32	4.57	-
A <sub>1</sub>	0.048	0.052	1.22	1.32	4, 5
b	0.030	0.034	0.77	0.86	4, 5
b <sub>1</sub>	0.045	0.055	1.15	1.39	4, 5
b <sub>2</sub>	0.310	-	7.88	-	2
c	0.018	0.022	0.46	0.55	4, 5
D	0.405	0.425	10.29	10.79	-
E	0.395	0.405	10.04	10.28	-
e	0.100 TYP		2.54 TYP		7
e <sub>1</sub>	0.200 BSC		5.08 BSC		7
H <sub>1</sub>	0.045	0.055	1.15	1.39	-
J <sub>1</sub>	0.095	0.105	2.42	2.66	-
L	0.175	0.195	4.45	4.95	-
L <sub>1</sub>	0.090	0.110	2.29	2.79	4, 6
L <sub>2</sub>	0.050	0.070	1.27	1.77	3
L <sub>3</sub>	0.315	-	8.01	-	2

NOTES:

1. These dimensions are within allowable dimensions of Rev. C of JEDEC TO-263AB outline dated 2-92.
2.  $L_3$  and  $b_2$  dimensions established a minimum mounting surface for terminal 4.
3. Solder finish uncontrolled in this area.
4. Dimension (without solder).
5. Add typically 0.002 inches (0.05mm) for solder plating.
6.  $L_1$  is the terminal length for soldering.
7. Position of lead to be measured 0.120 inches (3.05mm) from bottom of dimension D.
8. Controlling dimension: Inch.
9. Revision 8 dated 7-97.

**TO-263AB**

24mm TAPE AND REEL

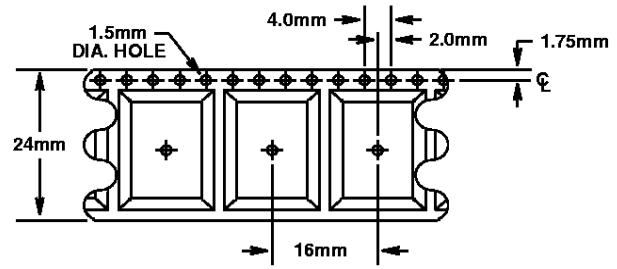
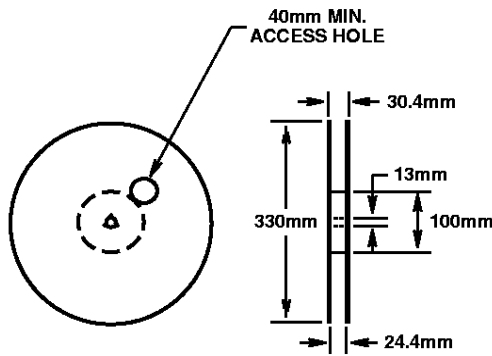

USER DIRECTION OF FEED

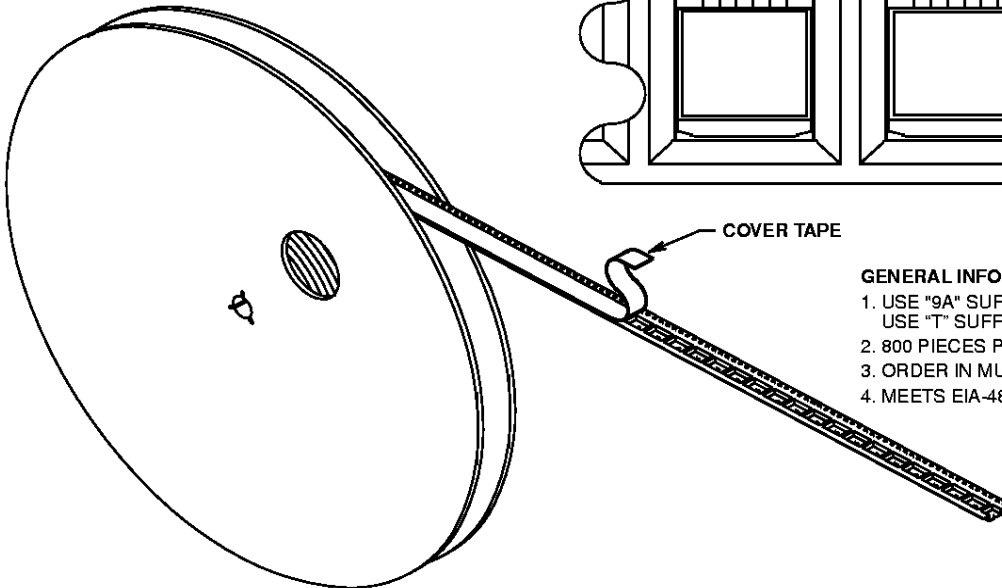
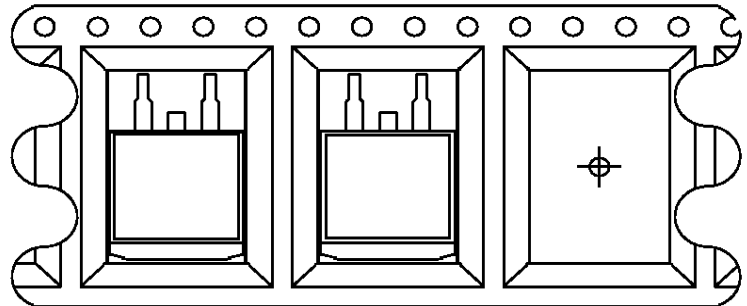

COVER TAPE

**GENERAL INFORMATION**

1. USE "9A" SUFFIX ON PART NUMBER.  
USE "T" SUFFIX ON PART FOR "HUF" SERIES.
2. 800 PIECES PER REEL.
3. ORDER IN MULTIPLES OF FULL REELS ONLY.
4. MEETS EIA-481 REVISION "A" SPECIFICATIONS.

Revision 8 dated 7-97

HGTD7N60B3, HGTD7N60B3S, HGT1S7N60B3, HGT1S7N60B3S, HGTP7N60B3

**TO-220AB**

3 LEAD JEDEC TO-220AB PLASTIC PACKAGE

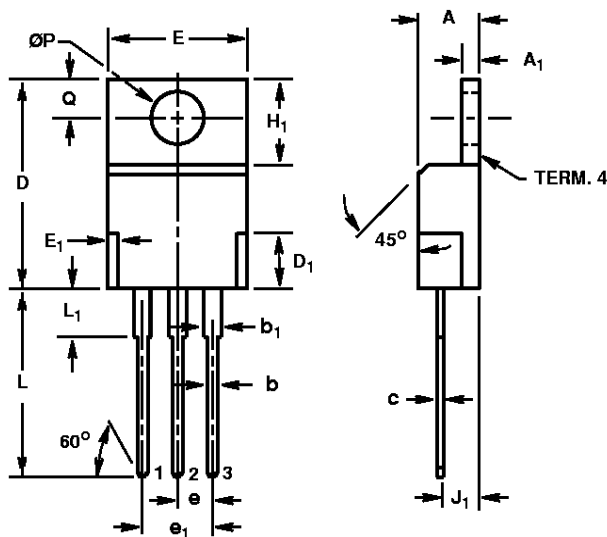

SYMBOL	INCHES		MILLIMETERS		NOTES
	MIN	MAX	MIN	MAX	
A	0.170	0.180	4.32	4.57	-
A <sub>1</sub>	0.048	0.052	1.22	1.32	-
b	0.030	0.034	0.77	0.86	3, 4
b <sub>1</sub>	0.045	0.055	1.15	1.39	2, 3
c	0.014	0.019	0.36	0.48	2, 3, 4
D	0.590	0.610	14.99	15.49	-
D <sub>1</sub>	-	0.160	-	4.06	-
E	0.395	0.410	10.04	10.41	-
E <sub>1</sub>	-	0.030	-	0.76	-
e	0.100 TYP		2.54 TYP		5
e <sub>1</sub>	0.200 BSC		5.08 BSC		5
H <sub>1</sub>	0.235	0.255	5.97	6.47	-
J <sub>1</sub>	0.100	0.110	2.54	2.79	6
L	0.530	0.550	13.47	13.97	-
L <sub>1</sub>	0.130	0.150	3.31	3.81	2
$\varnothing P$	0.149	0.153	3.79	3.88	-
Q	0.102	0.112	2.60	2.84	-

NOTES:

1. These dimensions are within allowable dimensions of Rev. J of JEDEC TO-220AB outline dated 3-24-87.
2. Lead dimension and finish uncontrolled in L<sub>1</sub>.
3. Lead dimension (without solder).
4. Add typically 0.002 inches (0.05mm) for solder coating.
5. Position of lead to be measured 0.250 inches (6.35mm) from bottom of dimension D.
6. Position of lead to be measured 0.100 inches (2.54mm) from bottom of dimension D.
7. Controlling dimension: Inch.
8. Revision 2 dated 7-97.

All Harris Semiconductor products are manufactured, assembled and tested under **ISO9000** quality systems certification.

*Harris Semiconductor products are sold by description only. Harris Semiconductor reserves the right to make changes in circuit design and/or specifications at any time without notice. Accordingly, the reader is cautioned to verify that data sheets are current before placing orders. Information furnished by Harris is believed to be accurate and reliable. However, no responsibility is assumed by Harris or its subsidiaries for its use; nor for any infringements of patents or other rights of third parties which may result from its use. No license is granted by implication or otherwise under any patent or patent rights of Harris or its subsidiaries.*

**Sales Office Headquarters**

For general information regarding Harris Semiconductor and its products, call **1-800-4-HARRIS**

**NORTH AMERICA**  
 Harris Semiconductor  
 P. O. Box 883, Mail Stop 53-210  
 Melbourne, FL 32902  
 TEL: 1-800-442-7747  
 (407) 729-4984  
 FAX: (407) 729-5321

**EUROPE**  
 Harris Semiconductor  
 Mercure Center  
 100, Rue de la Fusee  
 1130 Brussels, Belgium  
 TEL: (32) 2.724.2111  
 FAX: (32) 2.724.22.05

**ASIA**  
 Harris Semiconductor PTE Ltd.  
 No. 1 Tannery Road  
 Cencon 1, #09-01  
 Singapore 1334  
 TEL: (65) 748-4200  
 FAX: (65) 748-0400

