

Features

- 3V and 5V Input compatible
- Clocking speeds up to 10MHz
- Reduced clock skew
- 20ns Switching/delay time
- 2A Peak drive
- Low quiescent current
- Wide operating voltage – 4.5V-16V

Applications

- CCD Drivers requiring high-contrast imaging
- Differential line drivers
- Push-pull circuits

Ordering Information

Part No.	Package	Tape & Reel	Outline #
EL7182CN	PDIP-8	-	MDP0031
EL7182CS	SO-8	-	MDP0027
EL7182CS-T7	SO-8	7 in	MDP0027
EL7182CS-T13	SO-8	13 in	MDP0027

General Description

The EL7182C is extremely well suited for driving CCD's, especially where high contrast imaging is desirable. The 16V supply rating is attractive for higher voltage CCD applications, as in color fax machines. The input is TTL and 3V compatible. The low quiescent current requirement is advantageous in portable/battery powered systems. The EL7182C is available in 8-pin PDIP and 8-lead SO packages.

Connection Diagrams

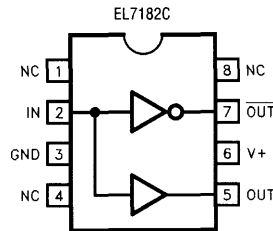

Manufactured under U.S. Patent Nos. 5,334,883, #5,341,047

EL7182C

2-Phase, High Speed CCD Driver

Absolute Maximum Ratings (T_A = 25 °C)

Supply (V+ to Gnd)	16.5V	Operating Junction Temperature	125°C
Input Pins	-0.3V to +0.3V above V+	Power Dissipation	
Combined Peak Output Current	4A	SO	570mW
Storage Temperature Range	-65°C to +150°C	PDIP	1050mW
Ambient Operating Temperature	-40°C to +85°C		

Important Note:

All parameters having Min/Max specifications are guaranteed. Typ values are for information purposes only. Unless otherwise noted, all tests are at the specified temperature and are pulsed tests, therefore: T_J = T_C = T_A

DC Electrical Characteristics

T_A = 25°C, V = 15V unless otherwise specified

Parameter	Description	Test Conditions	Min	Typ	Max	Units
Input	V _{IH}	Logic "1" Input Voltage	2.4			V
	I _{IH}	Logic "1" Input Current	@V+	0.1	10	μA
	V _{IL}	Logic "0" Input Voltage			0.8	V
	I _{IL}	Logic "0" Input Current	@0V	0.1	10	μA
	V _{HVS}	Input Hysteresis		0.3		V
Output	R _{OH}	Pull-Up Resistance	I _{OUT} = -100mA	3	6	Ω
	R _{OL}	Pull-Down Resistance	I _{OUT} = +100mA	4	6	Ω
	I _{PK}	Peak Output Current	Source Sink	2 2		A
	I _{DC}	Continuous Output Current	Source/Sink	100		mA
Power Supply	I _S	Power Supply Current	Input High	2.5	5	mA
	V _S	Operating Voltage		4.5	16	V

AC Electrical Characteristics

T_A = 25°C, V = 15V unless otherwise specified

Parameter	Description	Test Conditions	Min	Typ	Max	Units
Switching Characteristics	t _R	Rise Time	C _L = 500pF C _L = 1000pF	7.5 10	20	ns
	t _F	Fall Time	C _L = 500pF C _L = 1000pF	10 13	20	ns
	t _{D-ON}	Turn-On Delay Time		18	25	ns
	t _{D-OFF}	Turn-Off Delay Time		20	25	ns

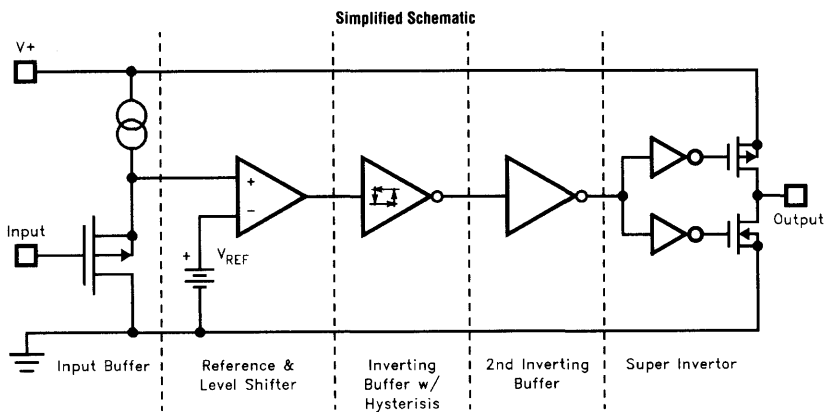
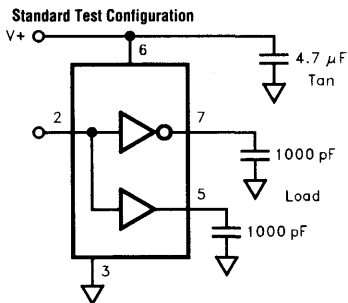
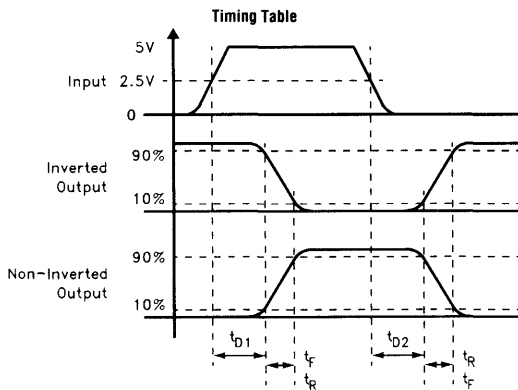

EL7182C

2-Phase, High Speed CCD Driver

Typical Performance Curves

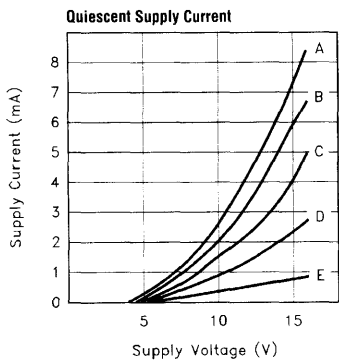
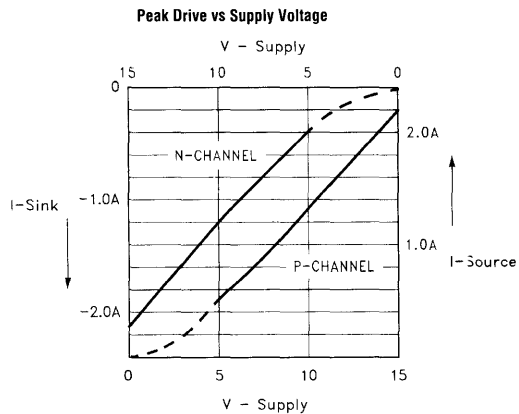
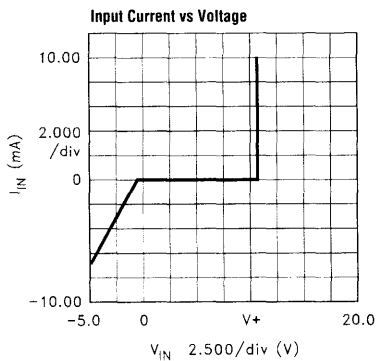
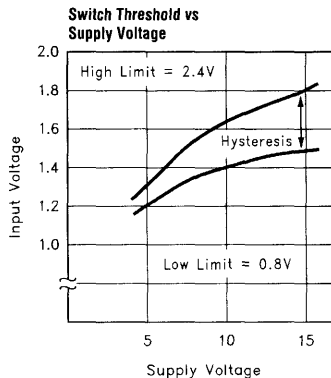
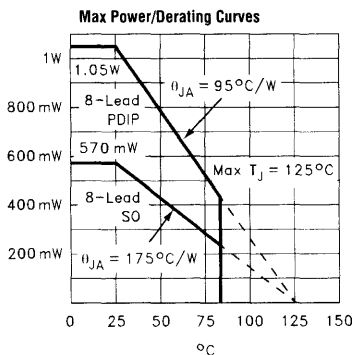

CASE:

Input Level	Curve
GND	B
V+	D

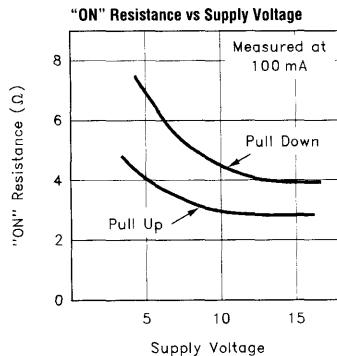

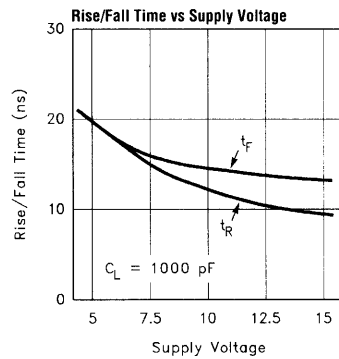
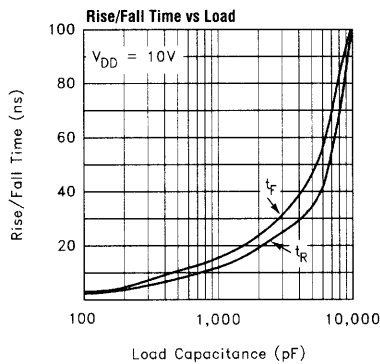
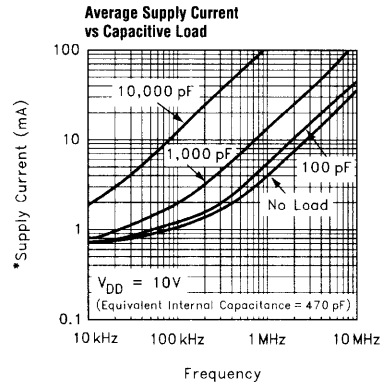
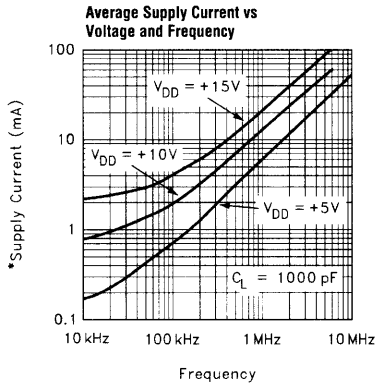

EL7182C

2-Phase, High Speed CCD Driver

