



MPQ2178A

5.5V, 2A, 2.4MHz, Synchronous Step-Down Converter with Power Good and Soft Start, AEC-Q100 Qualified

DESCRIPTION

The MPQ2178A is a monolithic, step-down switch-mode converter with built-in internal power MOSFETs. It achieves 2A of continuous output current across a 2.5V to 5.5V input voltage range, with excellent load and line regulation. The output voltage (V_{OUT}) can be regulated to as low as 0.6V.

The constant-on-time (COT) control scheme provides fast transient response and eases loop stabilization. Fault protections include cycle-by-cycle current limiting and thermal shutdown.

The MPQ2178A is ideal for a wide range of applications, including automotive infotainment systems, clusters, and telematics.

The MPQ2178A requires a minimal number of readily available, standard external components. It is available in an ultra-small QFN-8 (1.5mmx2mm) package.

FEATURES

- Designed for Automotive Applications:
 - Wide 2.5V to 5.5V Operating Input Voltage Range
 - Up to 2A Output Current
 - 1% FB Accuracy
 - Junction Temperature Operates from -40°C to +150°C
 - AEC-Q100 Grade 1 Qualified
- Improved Battery Life:
 - 21µA Sleep Mode Quiescent Current
 - Advanced Asynchronous Mode (AAM) Increases Efficiency under Light Loads
- High Performance for Improved Thermals:
 - 70mΩ and 40mΩ Internal Power MOSFET Switches
- Optimized for EMC/EMI:
 - 2.4MHz Switching Frequency
 - MeshConnect™ Flip-Chip Package
- Optimized for Board Size and BOM:
 - Built-In Internal Power MOSFETs
 - Integrated Compensation Network
 - Available in a Compact QFN-8 (1.5mmx2mm) Package
- Additional Features:
 - EN for Power Sequencing
 - Power Good (PG)
 - 100% Duty On
 - External Soft Start (SS) Control
 - Output Discharge
 - Output Over-Voltage Protection (OVP)
 - Short-Circuit Protection (SCP) with Hiccup Mode
 - Available in a Wettable Flank Package

APPLICATIONS

- Automotive Infotainment
- Camera Modules
- Key Fobs
- Automotive Clusters
- Automotive Telematics
- Industrial Supplies
- Battery-Powered Devices

All MPS parts are lead-free, halogen-free, and adhere to the RoHS directive. For MPS green status, please visit the MPS website under Quality Assurance. "MPS", the MPS logo, and "Simple, Easy Solutions" are trademarks of Monolithic Power Systems, Inc. or its subsidiaries.

TYPICAL APPLICATION

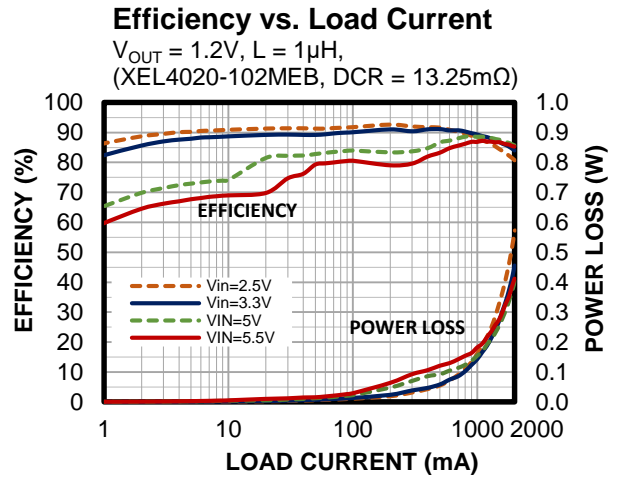
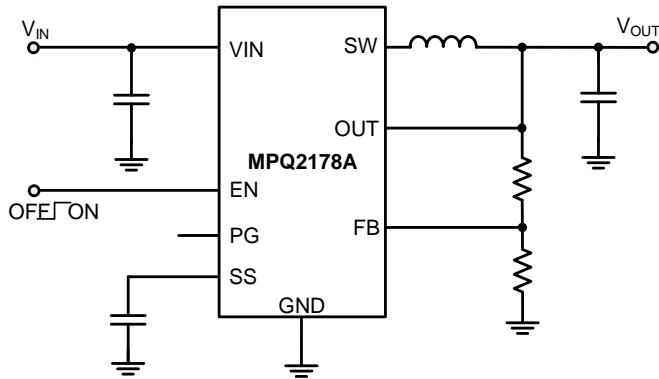

ORDERING INFORMATION

Part Number*	Package	Top Marking	MSL Rating**
MPQ2178AGQHE-AEC1***	QFN-8 (1.5mmx2mm)	See Below	1

* For Tape & Reel, add suffix -Z (e.g. MPQ2178AGQHE-AEC1-Z).

** Moisture Sensitivity Level Rating

*** Wettable flank

TOP MARKING

—
MB

LL

MB: Product code of MPQ2178AGQHE-AEC1

LL: Lot number

PACKAGE REFERENCE

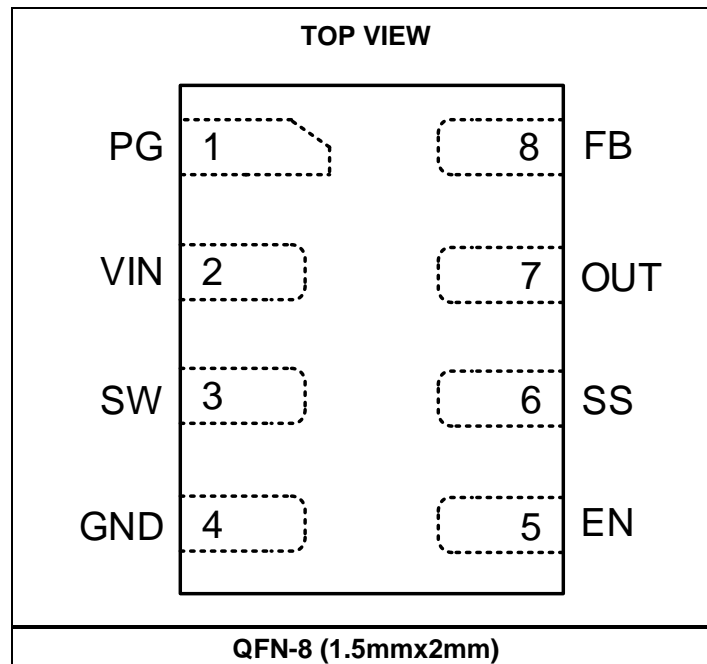

PIN FUNCTIONS

Pin #	Name	Description
1	PG	Power good indicator. The output of the PG pin is an open drain. Connect PG to a voltage source using an external resistor. PG is pulled high when V_{FB} exceeds 90% of V_{REF} ; PG is pulled low to GND when V_{FB} drops below 85% of V_{REF} . Float this pin if it is not used.
2	VIN	Supply voltage. The MPQ2178A operates from a 2.5V to 5.5V input. A decouple capacitor is required to prevent large voltage spikes from appearing at the input.
3	SW	Output switching node. SW is the drain of the internal high-side P-channel MOSFET. Connect the inductor to SW to complete the converter.
4	GND	Ground.
5	EN	Enable control. Pull EN below the falling threshold (0.65V) to shut down the chip. Pull EN above the rising threshold (0.9V) to enable the chip. There is an internal 2M Ω resistor connected from the EN pin to ground.
6	SS	Soft start. Connect a capacitor across SS and GND to set the soft-start time (t_{SS}) to avoid start-up inrush current. The minimum recommended soft-start capacitance (C_{SS}) is 1nF.
7	OUT	Output voltage. OUT is the power rail and input sense pin for the output voltage. Connect the load to this pin. An output capacitor is required to reduce the output voltage ripple.
8	FB	Feedback. Connect an external resistor divider from the output to GND, tapped to the FB pin. The FB voltage (V_{FB}) is compared to the internal 0.6V reference voltage (V_{REF}) to set the regulation voltage.

ABSOLUTE MAXIMUM RATINGS ⁽¹⁾

All pins	-0.3V to +6.5V
Junction temperature	150°C
Lead temperature	260°C
Continuous power dissipation ($T_A = 25^\circ\text{C}$) ^{(2) (4)}	2.2W
Storage temperature	-65°C to +150°C

ESD Ratings

Human body model (HBM)	$\pm 2000\text{V}$
Charged device model (CDM)	$\pm 750\text{V}$

Recommended Operating Conditions

Supply Voltage (V_{IN}).....	2.5V to 5.5V
Output Voltage (V_{OUT}).....	0.6V to $V_{IN} - 0.5\text{V}$
Operating junction temp (T_J)....	-40°C to +150°C

Thermal Resistance

	θ_{JA}	θ_{JC}
QFN-8 (1.5mmx2mm)		
JESD51-7 ⁽³⁾	130.....	25.....°C/W
EVQ2178A-LE-00A ⁽⁴⁾	59.....	14....°C/W

Notes:

- Exceeding these ratings may damage the device.
- The maximum allowable power dissipation is a function of the maximum junction temperature, T_J (MAX), the junction-to-ambient thermal resistance, θ_{JA} , and the ambient temperature, T_A . The maximum allowable continuous power dissipation at any ambient temperature is calculated by P_D (MAX) = $(T_J$ (MAX) - T_A) / θ_{JA} . Exceeding the maximum allowable power dissipation can cause excessive die temperature, and the device may go into thermal shutdown. Internal thermal shutdown circuitry protects the device from permanent damage.
- Measured on JESD51-7, 4-layer PCB. The values given in this table are only valid for comparison with other packages and cannot be used for design purposes. These values were calculated in accordance with JESD51-7, and simulated on a specified JEDEC board. They do not represent the performance obtained in an actual application.
- Measured on EVQ2178A-LE-00A, 6.3cmx6.3cm, 2oz per layer, 4-layer PCB.

ELECTRICAL CHARACTERISTICS

$V_{IN} = 3.6V$, $T_J = -40^{\circ}C$ to $+150^{\circ}C$, typical value tested at $T_J = 25^{\circ}C$, unless otherwise noted.

Parameter	Symbol	Condition	Min	Typ	Max	Units
V_{IN} range			2.5		5.5	V
Under-voltage lockout rising threshold				2.3	2.45	V
Under-voltage lockout threshold hysteresis				200		mV
Shutdown supply current		$V_{EN} = 0V$, $T_J = 25^{\circ}C$		0.01	1	μA
		$V_{EN} = 0V$, $T_J = -40^{\circ}C$ to $+125^{\circ}C$ ⁽⁶⁾			3	μA
		$V_{EN} = 0V$, $T_J = -40^{\circ}C$ to $+150^{\circ}C$			20	μA
Quiescent supply current		$V_{EN} = 2V$, $V_{FB} = 0.63V$, $V_{IN} = 3.6V$, $T_J = 25^{\circ}C$		21	30	μA
		$V_{EN} = 2V$, $V_{FB} = 0.63V$, $V_{IN} = 3.6V$, $T_J = -40^{\circ}C$ to $+125^{\circ}C$ ⁽⁶⁾			40	μA
		$V_{EN} = 2V$, $V_{FB} = 0.63V$, $V_{IN} = 3.6V$, $T_J = -40^{\circ}C$ to $+150^{\circ}C$			80	μA
Feedback voltage	V_{FB}	$T_J = 25^{\circ}C$	594	600	606	mV
		$T_J = -40^{\circ}C$ to $+150^{\circ}C$	591	600	609	
Feedback current	I_{FB}	$V_{FB} = 0.63V$		50	100	nA
P-channel MOSFET switch on resistance	$R_{DS(ON)_P}$	$V_{IN} = 5V$		70	100	m Ω
N-channel MOSFET switch on resistance	$R_{DS(ON)_N}$	$V_{IN} = 5V$		40	60	m Ω
ZCD				50		mA
Switch leakage		$V_{EN} = 0V$, $V_{IN} = 6V$, $V_{SW} = 0V$ or $6V$, $T_J = 25^{\circ}C$		0	1	μA
		$V_{EN} = 0V$, $V_{IN} = 6V$, $V_{SW} = 0V$ or $6V$, $T_J = -40^{\circ}C$ to $+125^{\circ}C$ ⁽⁶⁾			30	μA
Switching frequency	f_{SW}	$V_{IN} = 5V$, $V_{OUT} = 1.2V$, operating under CCM	2000	2400	2640	kHz
Minimum on time ⁽⁶⁾	t_{MIN-ON}	$V_{IN} = 5V$		50		ns
Minimum off time ⁽⁶⁾	$t_{MIN-OFF}$	$V_{IN} = 5V$		80		ns
P-channel MOSFET peak current limit			2.5	3.5	4.5	A
N-channel MOSFET valley current limit			1	2	3	A
Soft-start current	I_{SS_ON}		1.5	3	4.5	μA
Maximum duty cycle				100		%
Power good UV rising threshold		FB rising edge	87	90	93	%
Power good UV falling threshold		FB falling edge	82	85	88	%
Power good delay	t_{PGD}	PG rising/falling edge		80		μs

ELECTRICAL CHARACTERISTICS (continued)
 $V_{IN} = 3.6V$, $T_J = -40^{\circ}C$ to $+150^{\circ}C$, typical value tested at $T_J = 25^{\circ}C$, unless otherwise noted.

Parameter	Symbol	Condition	Min	Typ	Max	Units
Power good sink current capability	V_{PG-L}	Sink 1mA			0.4	V
Power good logic high voltage	V_{PG-H}	$V_{IN} = 5V$, $V_{FB} = 0.6V$	4.9			V
Self-biased PG ⁽⁵⁾					0.7	V
Power good leakage current/logic high		5V logic high			100	nA
EN turn-on delay		EN on to SW active		100		us
EN turn-off delay		EN off to stop switching		30		us
EN input logic low voltage			0.4	0.65		V
EN input logic high voltage				0.9	1.2	V
EN pull-down resistor				2		MΩ
Output discharge resistor	R_{DIS}	$V_{EN} = 0V$, $V_{OUT} = 1.2V$		150		Ω
EN input current		$V_{EN} = 2V$		1.2		μA
		$V_{EN} = 0V$		0		μA
Output over-voltage rising threshold	V_{OVP}		110%	115%	120%	V_{FB}
Output over-voltage hysteresis	V_{OVP_HYS}			10%		V_{FB}
Output over-voltage delay				2		us
Low-side current limit		Current flowing from SW to GND		1.2		A
Absolute V_{IN} OVP		After V_{OUT} OVP is enabled		6.1		V
Absolute V_{IN} OVP hysteresis				160		mV
Thermal shutdown ⁽⁶⁾				170		°C
Thermal shutdown hysteresis ⁽⁶⁾				20		°C

Notes:

- 5) $V_{IN} = 0V$, $EN = 0V$, PG pulled up to 3.0V to 5.5V with a 100kΩ resistor.
 6) Guaranteed by design and bench characterization. Not tested in production.

TYPICAL CHARACTERISTICS

$V_{IN} = 3.6V$, $T_J = -40^{\circ}C$ to $+150^{\circ}C$, unless otherwise noted.

V_{IN} UVLO Threshold vs. Temperature

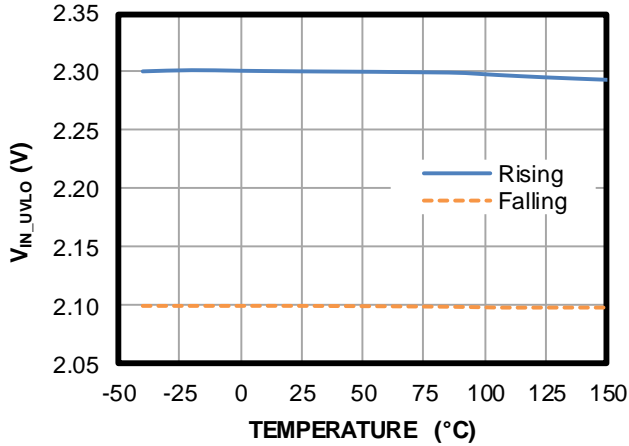

EN Rising and Falling Threshold vs. Temperature

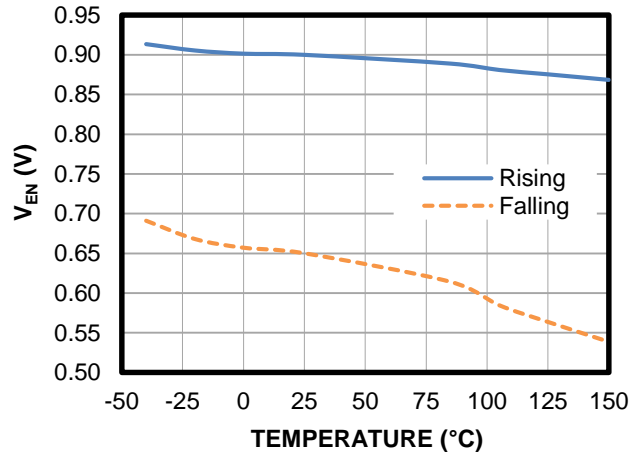

Shutdown Current vs. Temperature

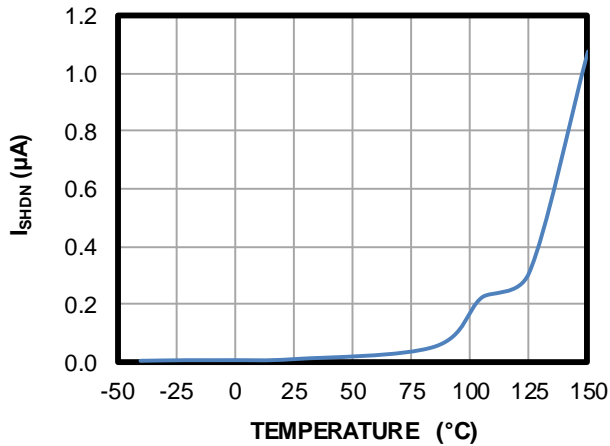

Quiescent Current vs. Temperature

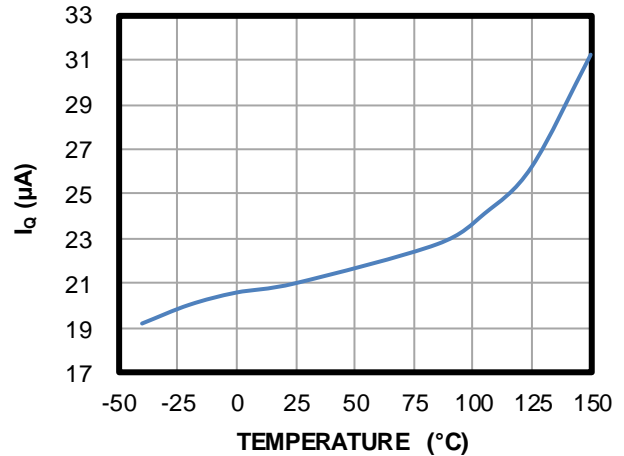

Feedback Voltage vs. Temperature

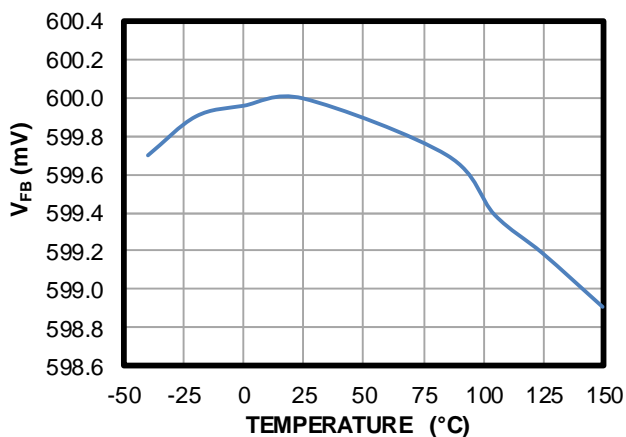

Switching Frequency vs. Temperature

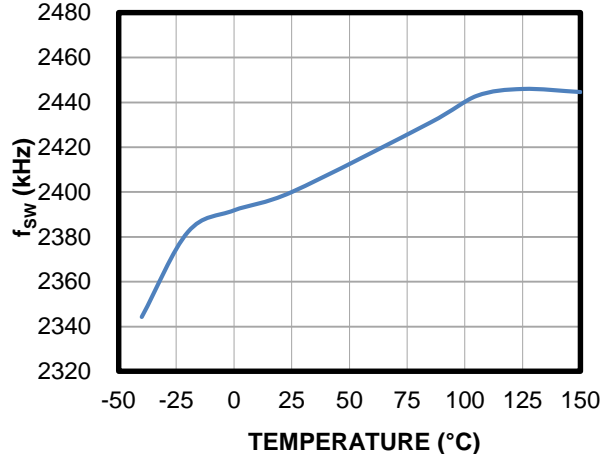

TYPICAL CHARACTERISTICS (continued)
 $V_{IN} = 3.6V$, $T_J = -40^{\circ}C$ to $+150^{\circ}C$, unless otherwise noted.

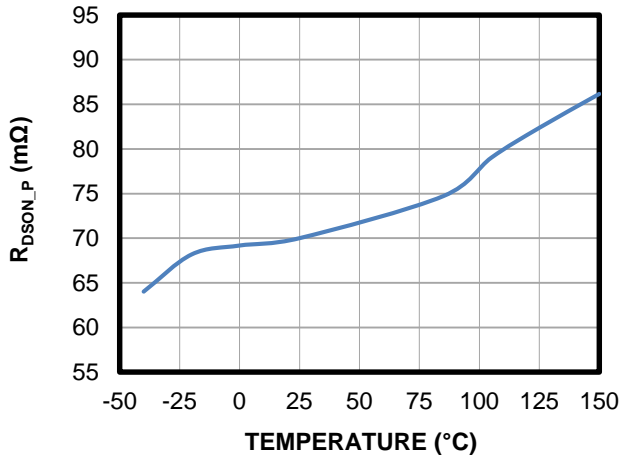
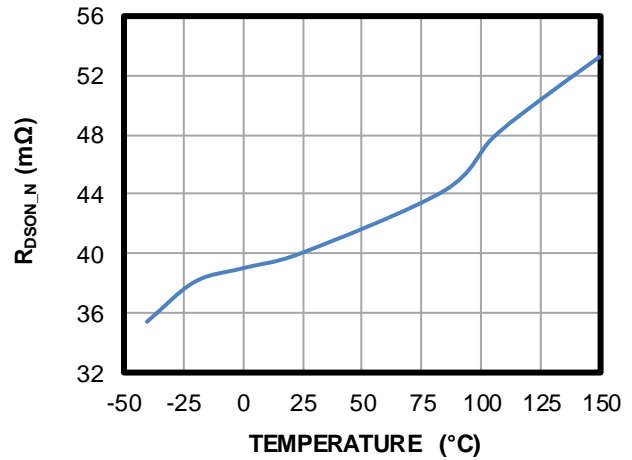
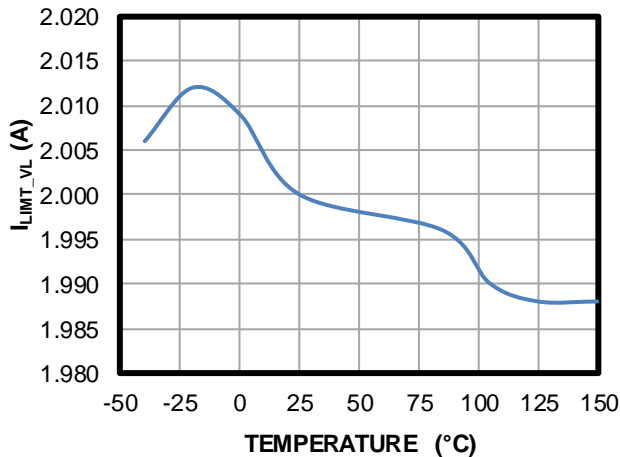
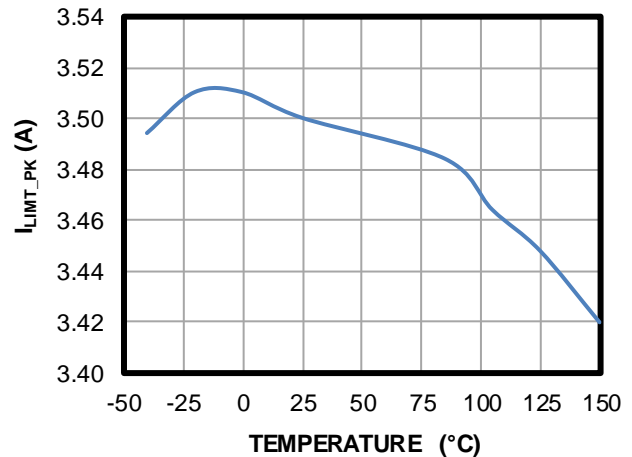
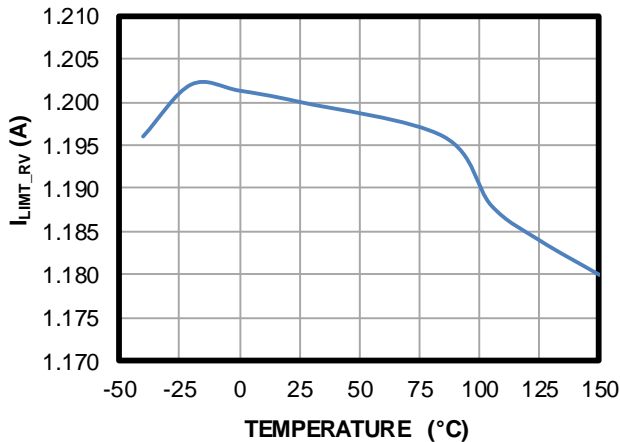
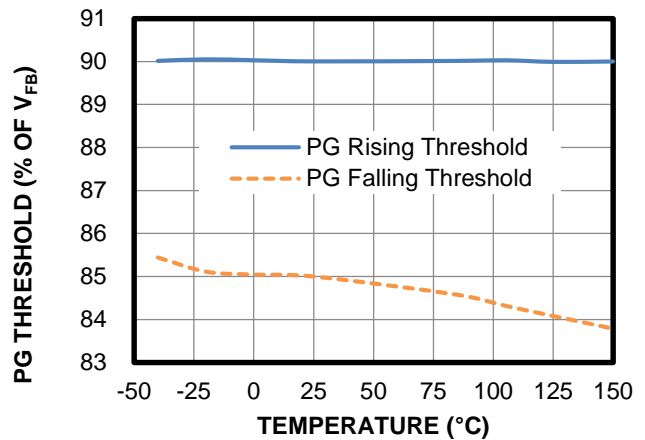
P-Channel MOSFET On Resistance vs. Temperature

N-Channel MOSFET On Resistance vs. Temperature

N-Channel MOSFET Valley Current Limit vs. Temperature

P-Channel MOSFET Peak Current Limit vs. Temperature

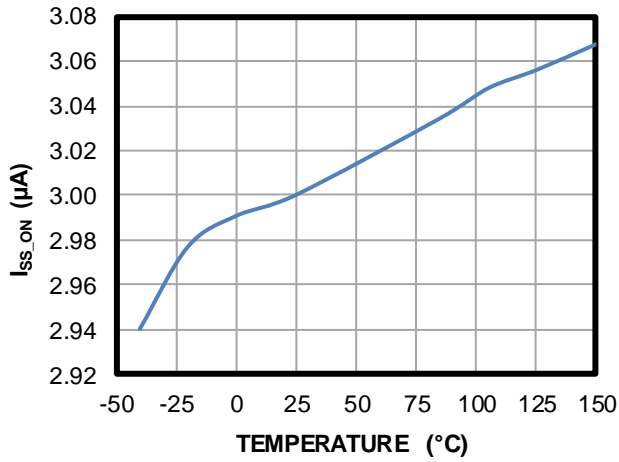
Low-Side Reverse Current Limit vs. Temperature

PG Rising/Falling Threshold vs. Temperature

TYPICAL CHARACTERISTICS (continued)

$V_{IN} = 3.6V$, $T_J = -40^{\circ}C$ to $+150^{\circ}C$, unless otherwise noted.

Soft-Start Current vs. Temperature



ZCD Current vs. Temperature

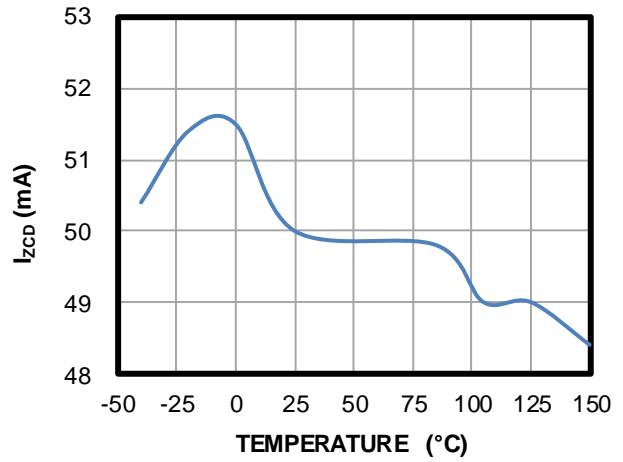

TYPICAL PERFORMANCE CHARACTERISTICS

$V_{IN} = 3.3V$, $V_{OUT} = 1.2V$, $L = 1\mu H$, $C_{OUT} = 22\mu F$, $T_A = 25^\circ C$, unless otherwise noted.

Efficiency vs. Load Current

$V_{OUT} = 1.2V$, $L = 1\mu H$,
(XEL4020-102MEB, DCR = 13.25m Ω)

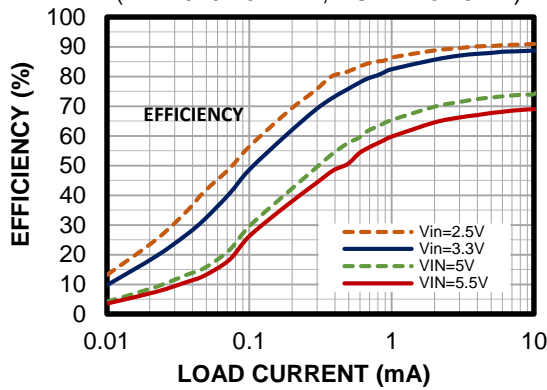

Efficiency vs. Load Current

$V_{OUT} = 1.2V$, $L = 1\mu H$,
(XEL4020-102MEB, DCR = 13.25m Ω)

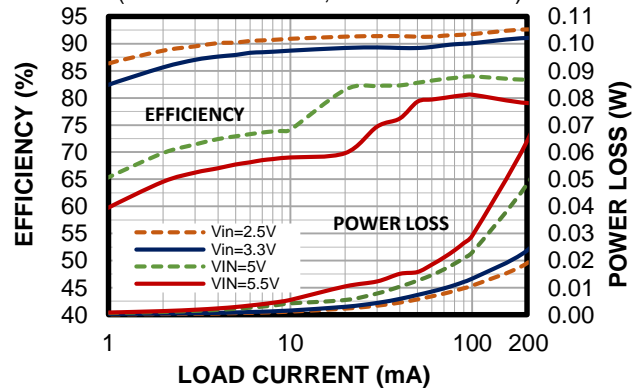

Efficiency vs. Load Current

$V_{OUT} = 1.2V$, $L = 1\mu H$,
(XEL4020-102MEB, DCR = 13.25m Ω)

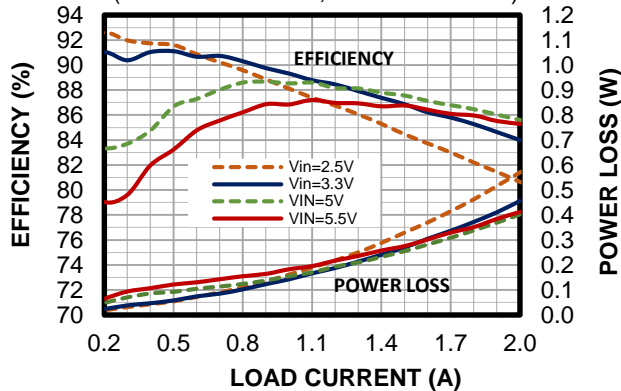

Efficiency vs. Load Current

$V_{OUT} = 1.8V$, $L = 1\mu H$,
(XEL4020-102MEB, DCR = 13.25m Ω)

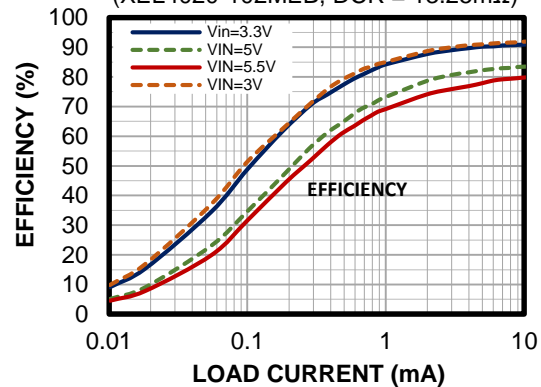

Efficiency vs. Load Current

$V_{OUT} = 1.8V$, $L = 1\mu H$,
(XEL4020-102MEB, DCR = 13.25m Ω)

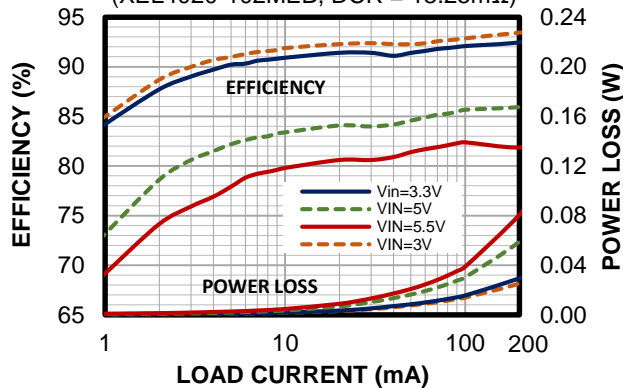

Efficiency vs. Load Current

$V_{OUT} = 1.8V$, $L = 1\mu H$,
(XEL4020-102MEB, DCR = 13.25m Ω)

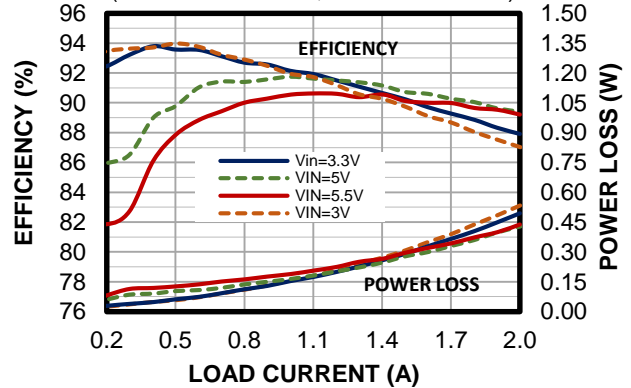

TYPICAL PERFORMANCE CHARACTERISTICS (continued)

$V_{IN} = 3.3V$, $V_{OUT} = 1.2V$, $L = 1\mu H$, $C_{OUT} = 22\mu F$, $T_A = 25^\circ C$, unless otherwise noted.

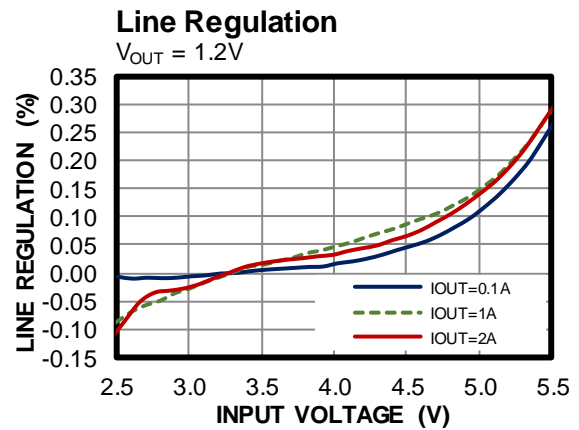
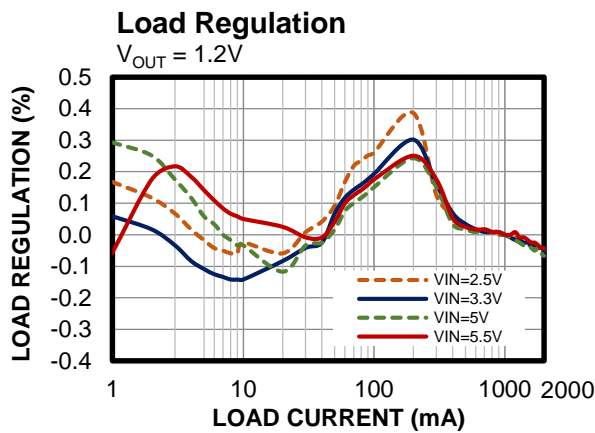
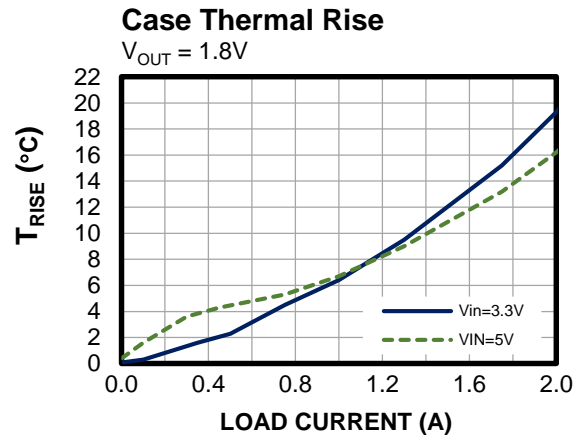
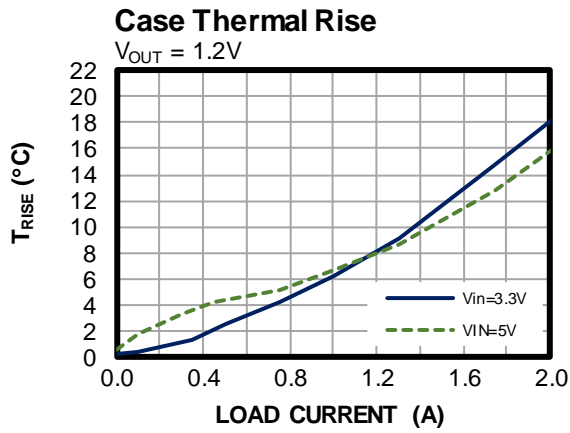

TYPICAL PERFORMANCE CHARACTERISTICS (continued)
 $V_{IN} = 3.3V$, $V_{OUT} = 1.2V$, $L = 1\mu H$, $C_{OUT} = 22\mu F$, $T_A = 25^\circ C$, unless otherwise noted.

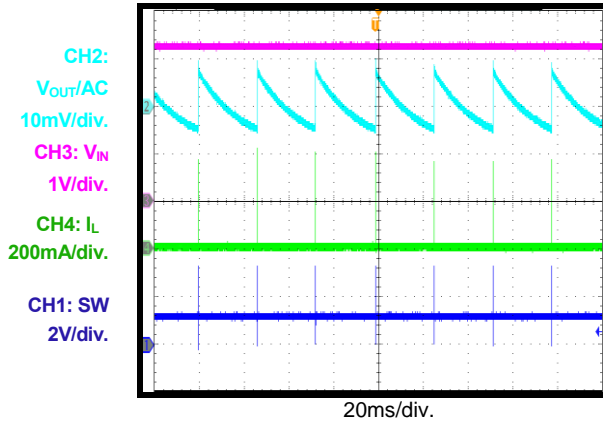
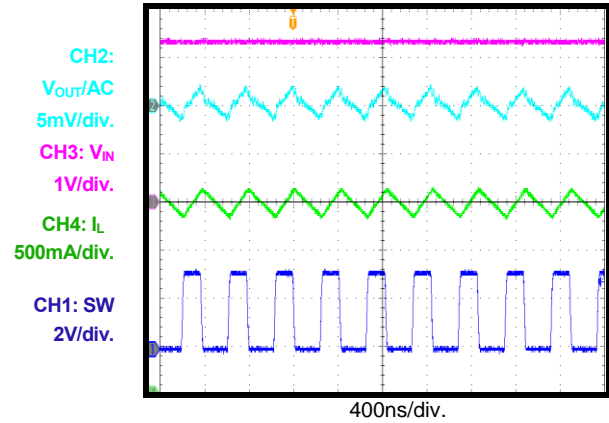
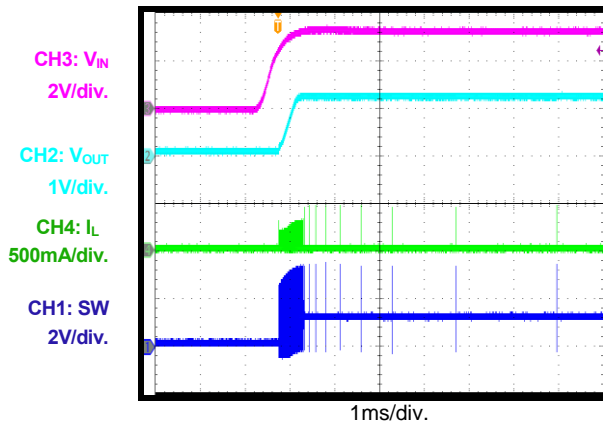
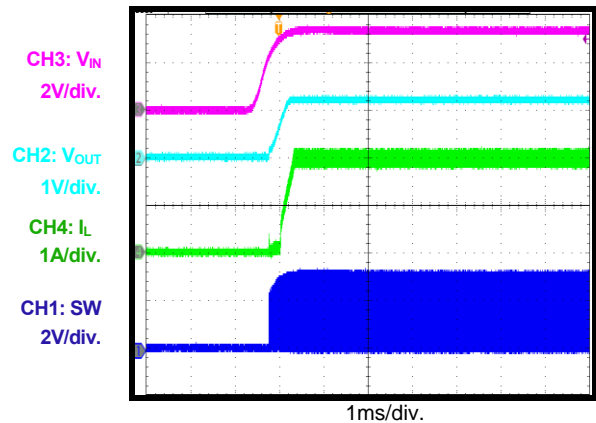
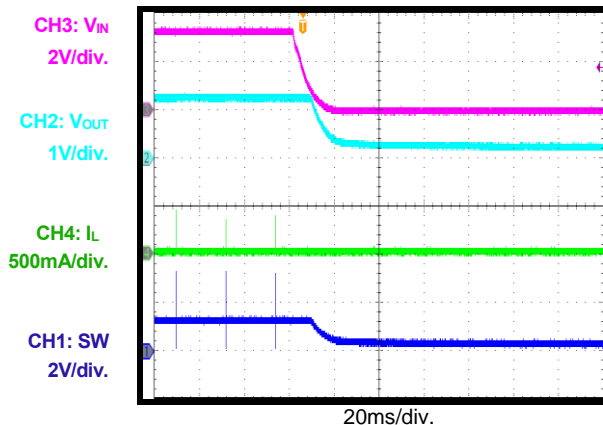
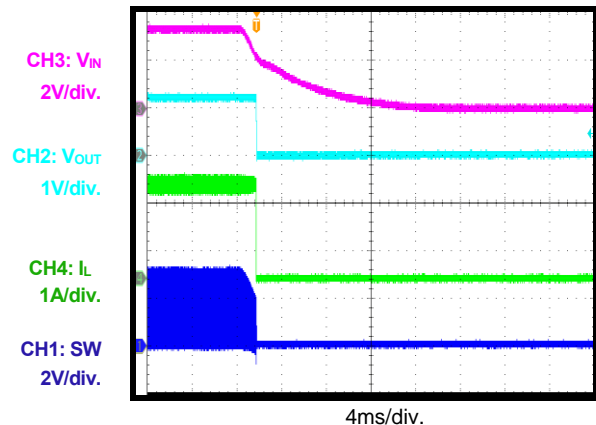
Steady State
 $I_{OUT} = 0A$

Steady State
 $I_{OUT} = 2A$

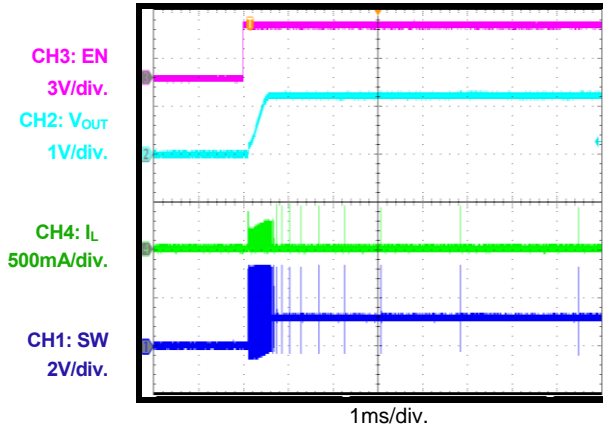
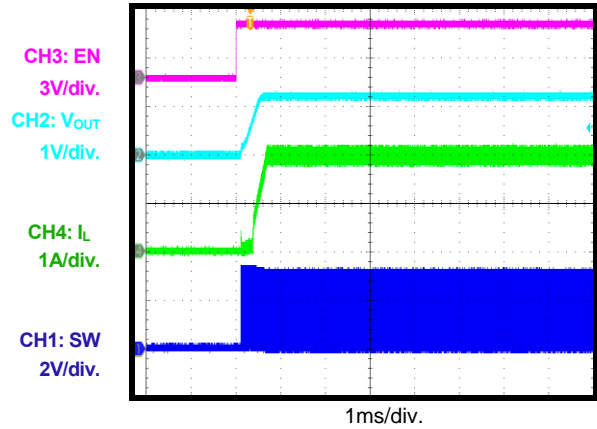
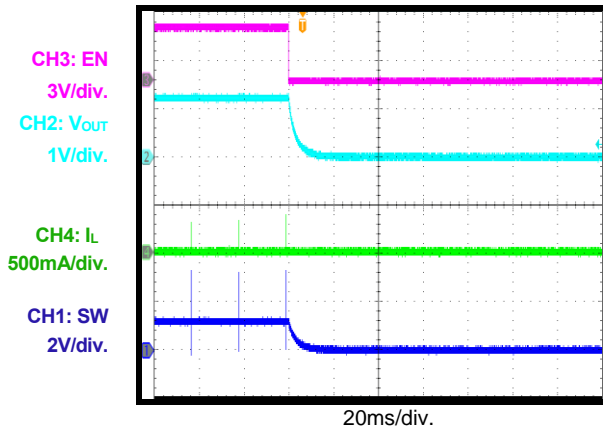
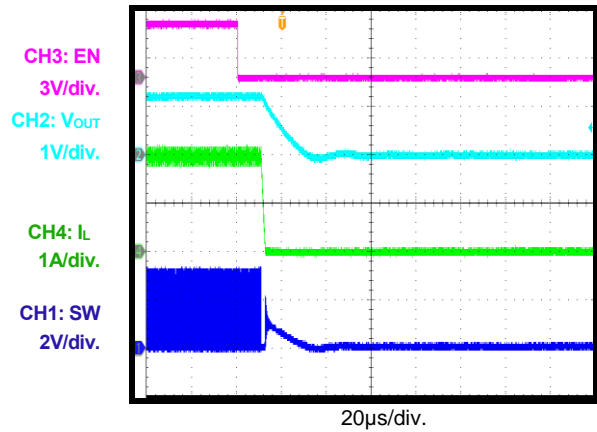
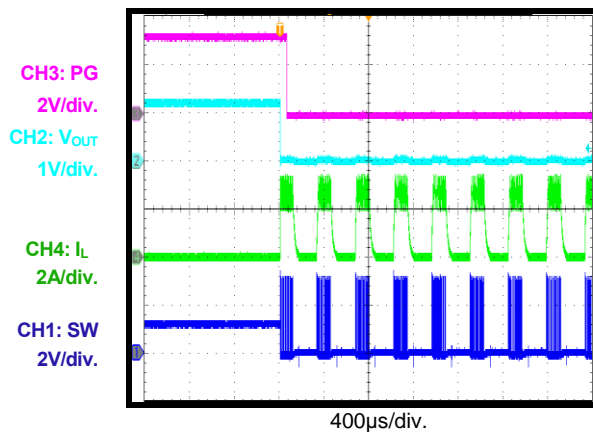
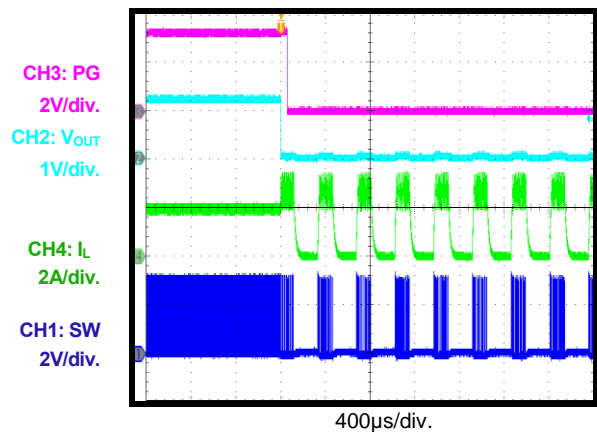
Start-Up through VIN
 $I_{OUT} = 0A$

Start-Up through VIN
 $I_{OUT} = 2A$

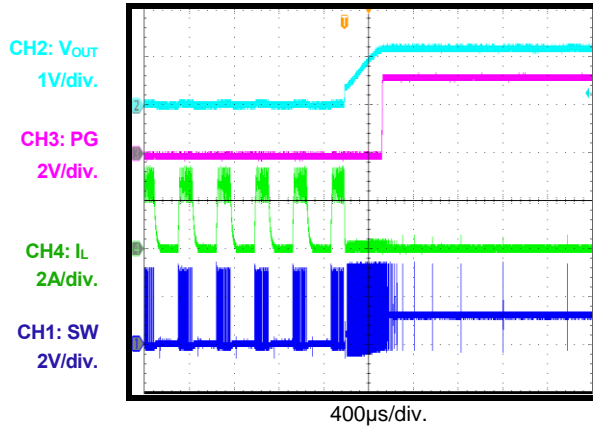
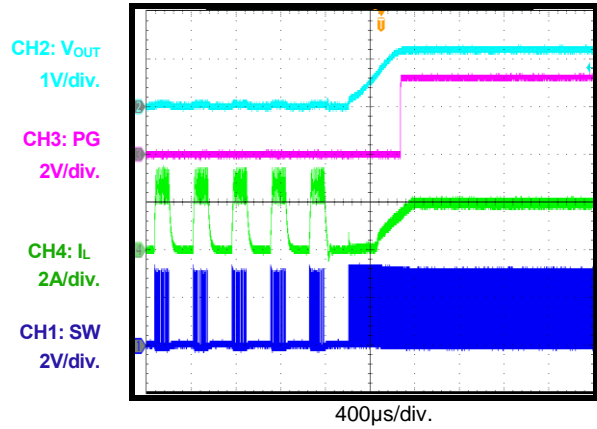
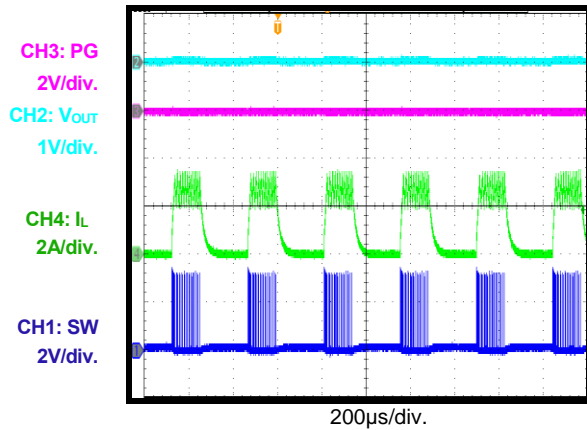
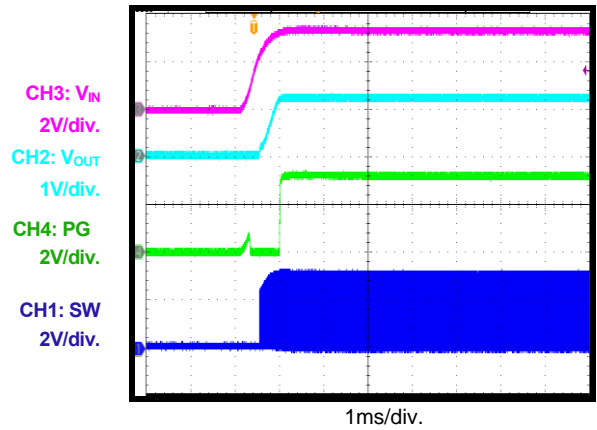
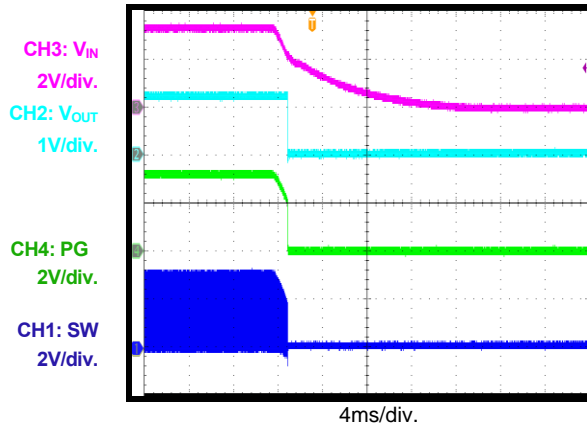
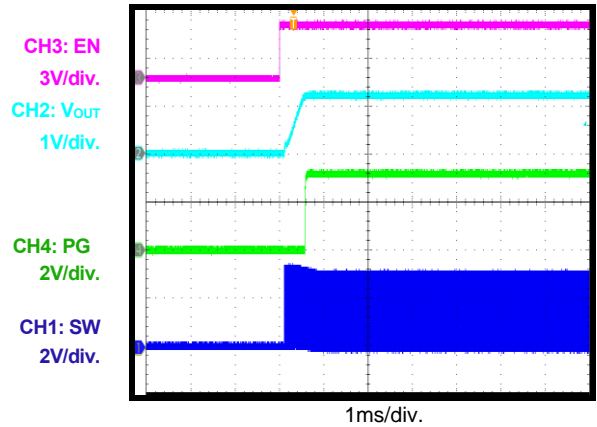
Shutdown through VIN
 $I_{OUT} = 0A$

Shutdown through VIN
 $I_{OUT} = 2A$

TYPICAL PERFORMANCE CHARACTERISTICS (continued)
 $V_{IN} = 3.3V$, $V_{OUT} = 1.2V$, $L = 1\mu H$, $C_{OUT} = 22\mu F$, $T_A = 25^\circ C$, unless otherwise noted.

Start-Up through EN
 $I_{OUT} = 0A$

Start-Up through EN
 $I_{OUT} = 2A$

Shutdown through EN
 $I_{OUT} = 0A$

Shutdown through EN
 $I_{OUT} = 2A$

SCP Entry
 $I_{OUT} = 0A$

SCP Entry
 $I_{OUT} = 2A$

TYPICAL PERFORMANCE CHARACTERISTICS (continued)
 $V_{IN} = 3.3V$, $V_{OUT} = 1.2V$, $L = 1\mu H$, $C_{OUT} = 22\mu F$, $T_A = 25^\circ C$, unless otherwise noted.

SCP Recovery
 $I_{OUT} = 0A$

SCP Recovery
 $I_{OUT} = 2A$

Short Circuit

PG Start-Up through VIN
 $I_{OUT} = 2A$

PG Shutdown through VIN
 $I_{OUT} = 2A$

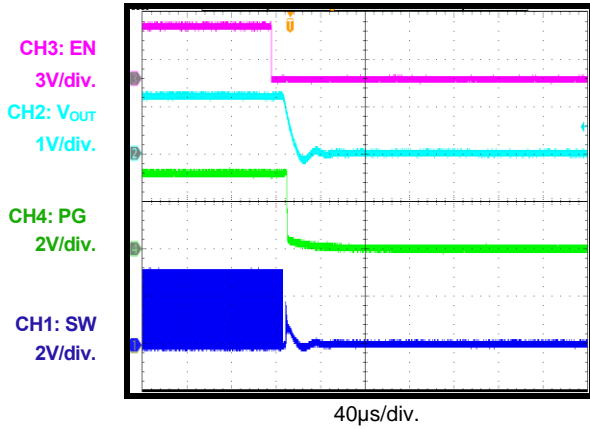
PG Start-Up through EN
 $I_{OUT} = 2A$

TYPICAL PERFORMANCE CHARACTERISTICS (Continued)

$V_{IN} = 3.3V$, $V_{OUT} = 1.2V$, $L = 1\mu H$, $C_{OUT} = 22\mu F$, $T_A = 25^\circ C$, unless otherwise noted.

PG in Shutdown through EN

$I_{OUT} = 2A$



Load Transient

$I_{OUT} = 1A$ to $2A$, $1A/\mu s$

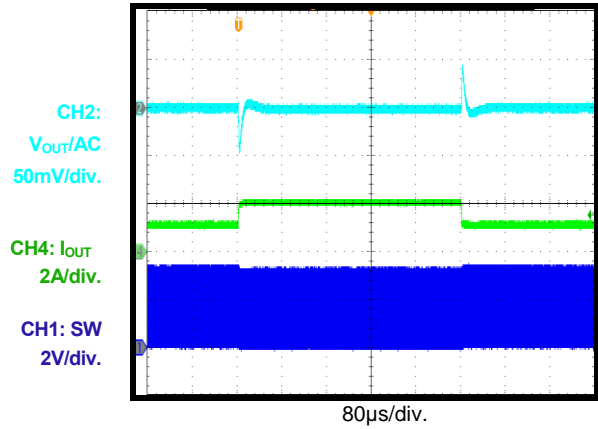

FUNCTIONAL BLOCK DIAGRAM

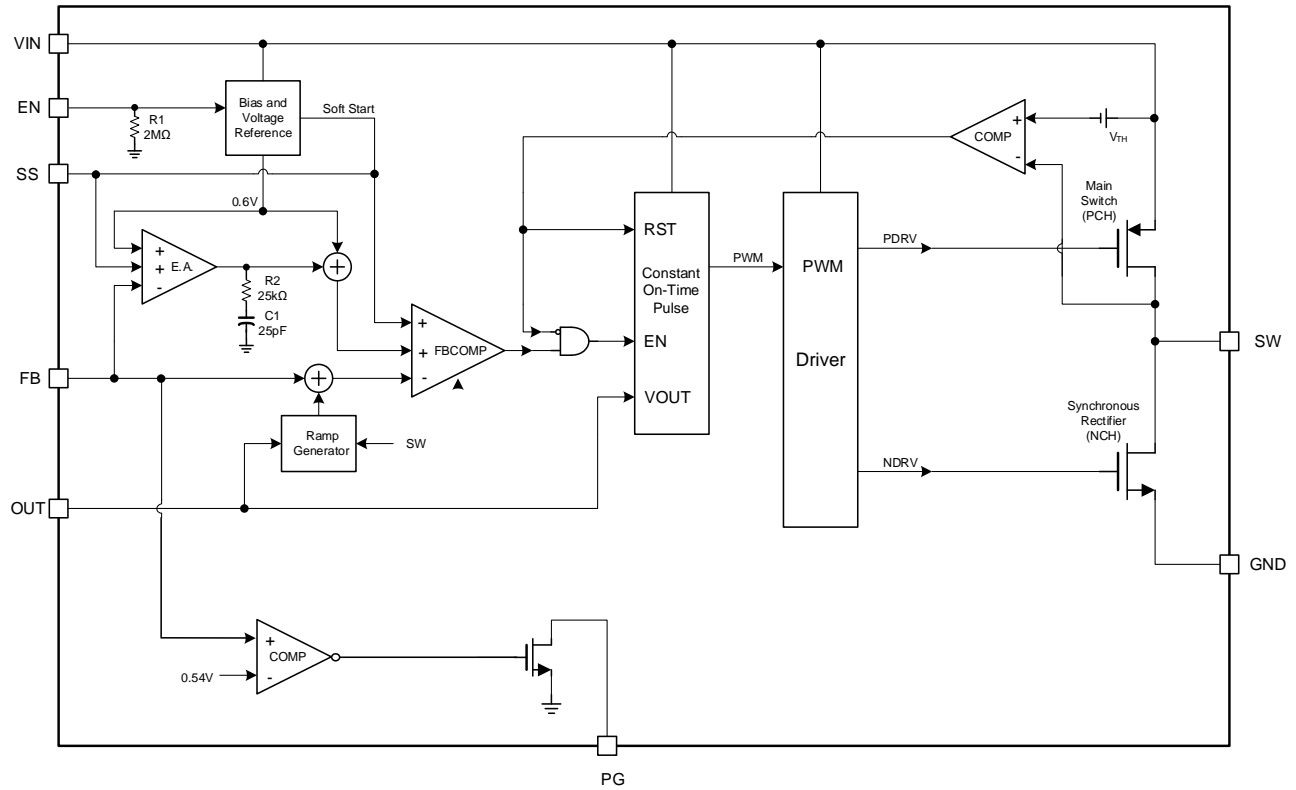

Figure 1: Functional Block Diagram

OPERATION

The MPQ2178A uses constant-on-time (COT) control with input voltage (V_{IN}) feed-forward to stabilize the switching frequency (f_{sw}) across the full input voltage range. The device achieves 2A of continuous output current (I_{OUT}) across the 2.5V to 5.5V V_{IN} range, with excellent load and line regulation. The output voltage (V_{OUT}) can be regulated to as low as 0.6V for the adjustable output version. The MPQ2178A is capable of reaching 100% maximum duty cycle in low-dropout mode.

Constant-On-Time (COT) Control

Compared to fixed-frequency pulse-width modulation (PWM) control, constant-on-time (COT) control offers a simpler control loop and faster transient response. To prevent inductor current (I_L) runaway during load transient, the MPQ2178A's MOSFET has a fixed minimum off time. When the low-side N-channel MOSFET (LS-FET) turns on, it remains on for at least t_{MIN_OFF} . The high-side P-channel MOSFET (HS-FET) turns on when the feedback voltage (V_{FB}) drops below the reference voltage (V_{REF}), which indicates an insufficient V_{OUT} . By using V_{IN} feed-forward, the MPQ2178A maintains a nearly constant f_{sw} across the input and load ranges. The switching pulse-on time (t_{ON}) can be estimated with Equation (1):

$$t_{ON} = \frac{V_{OUT}}{V_{IN}} \times 400ns \quad (1)$$

Sleep Mode Operation

The MPQ2178A provides sleep mode to obtain high efficiency at extremely light loads. In sleep mode, the input currents of most of the circuit blocks are decreased, especially the error amplifier and PWM comparator.

When the load gets lighter, the MPQ2178A slows down the frequency. If the load is further decreased and the off time is longer than $3.5\mu s$, the MPQ2178A enters sleep mode, which consumes very low quiescent current to further improve light-load efficiency.

The MPQ2178A exits sleep mode after a high-side pulse occurs.

Advanced Asynchronous Mode (AAM) under Light Loads

The MPQ2178A provides advanced asynchronous mode (AAM), which is a power-save mode that works with zero-current detection (ZCD) circuits for light-load conditions.

Figure 2 shows the simplified AAM control theory. The AAM current (I_{AAM}) is set internally. The SW pulse-on time is determined by the on-timer generator and AAM comparator.

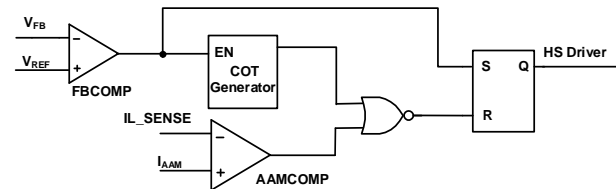

Figure 2: Simplified AAM Control Logic

Under light loads, the SW pulse-on time is the longer pulse. When the AAM comparator pulse is longer than the on-timer generator, the AAM comparator controls t_{ON} (Figure 3).

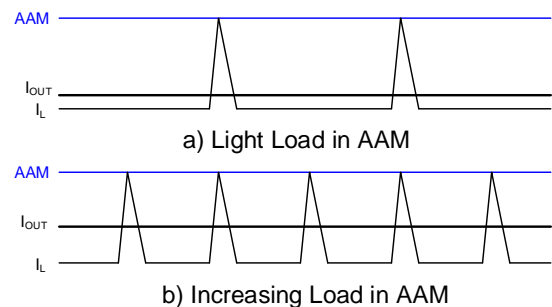

Figure 3: AAM Comparator Controls t_{ON}

When using a lower-value inductor, the AAM comparator pulse is shorter than the on-timer generator. Because the HS-FET depends on the on-timer generator, the on-timer controls t_{ON} in this scenario (see Figure 4).

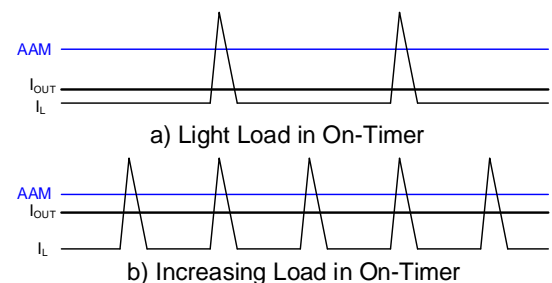

Figure 4: On-Timer Controls t_{ON}

In addition to the on-timer methods above, the AAM circuit has another 150ns blank time in sleep mode. This means that if the on-timer is shorter than 150ns, the HS-FET may turn off after the on-timer generator pulse, without AAM control.

The pulse-on time in sleep mode is about 40% longer than the pulse in discontinuous conduction mode (DCM) or continuous conduction mode (CCM). In this scenario, I_L may not reach the AAM threshold (see Figure 5).

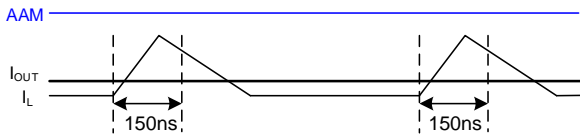

Figure 5: AAM Blank Time in Sleep Mode

Figure 6 shows how the AAM threshold decreases while t_{ON} increases. During CCM, I_{OUT} should exceed half of the AAM threshold.

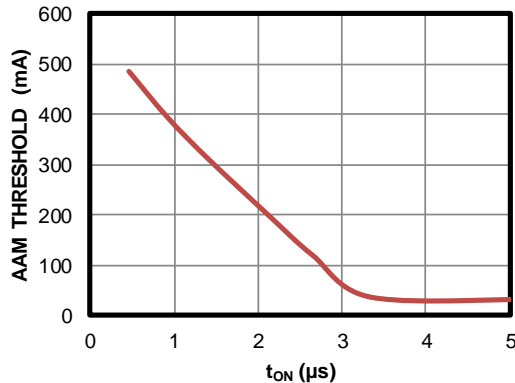

Figure 6: AAM Threshold Decreases while t_{ON} Increases

The MPQ2178A has a ZCD circuit that detects when the inductor current starts to reverse. When the inductor current reaches the ZCD threshold, the LS-FET turns off.

By pairing AAM with the ZCD circuit, the MPQ2178A always operates in DCM under light loads, even if V_{OUT} is almost equal to V_{IN} .

Enable (EN)

EN is a digital control pin that turns the MPQ2178A on and off. Pull EN above the EN rising threshold (0.9V) to turn the device on; pull EN below the falling threshold (0.65V) to turn it off. Disable the MPQ2178A by floating the EN pin or pulling it to ground.

There is an internal 2M Ω resistor connected

from the EN pin to ground.

Output Discharge

When the device is disabled, the part automatically goes into output discharge mode, and the internal discharge MOSFET provides a resistive discharge path from the OUT pin to GND for the output capacitor (C_{OUT}). Output discharge mode can be blocked by adding an external capacitor between the output and the OUT pin. See the Output Discharge Blocking section on page 22 for more details.

Soft Start (SS)

The MPQ2178A has an external SS pin that ramps up V_{OUT} at a controlled slew rate to avoid overshoot during start-up. The SS pin charge current is typically 3 μ A. The soft-start time (t_{SS}) is determined by the soft-start capacitor (C_{SS}). t_{SS} can be calculated with Equation (2):

$$t_{SS}(\text{ms}) = \frac{C_{SS}(\text{nF}) \times 0.6\text{V}}{I_{SS}(\mu\text{A})} \quad (2)$$

Where C_{SS} is the external soft-start capacitor, and I_{SS} is the internal 3 μ A SS charge current. C_{SS} should be at least 1nF.

The MPQ2178A offers a pre-biased start-up function. Once EN is enabled, the device starts up, even if there is a pre-biased voltage on the output. Pre-biased start-up can be implemented regardless of whether output discharge mode is blocked.

Peak and Valley Current Limit

Both the HS-FET and LS-FET have current limit protection. When I_L reaches the HS-FET's peak current limit (typically 3.5A) during the HS-FET on time, the HS-FET immediately turns off to prevent the current from rising further, and the LS-FET turns on to discharge the energy. The HS-FET does not turn on again until I_L drops below the valley current limit threshold (typically 2A). This current limit scheme helps prevent current runaway during overload and short-circuit events.

Short-Circuit Protection (SCP) and Recovery

If the output is shorted to ground and the MPQ2178A reaches its current limit, the device enters short-circuit protection (SCP) and tries to recover with hiccup mode.

During SCP, the MPQ2178A disables the output power stage, begins discharging the SS voltage (V_{SS}), and restarts with a full soft start once V_{SS} is fully discharged. This hiccup process repeats until the fault is removed.

Over-Voltage Protection (OVP)

The MPQ2178A monitors a resistor-divided feedback voltage to detect over-voltage (OV) conditions. If V_{FB} exceeds 115% of V_{REF} , the controller enters the dynamic regulation period. During this period, the LS-FET remains on until the LS-FET current reaches -1.2A. This process discharges V_{OUT} and tries to keep it within the normal range.

If the OV condition still remains, the LS-FET turns on again after a 1.5 μ s delay. Once V_{FB} falls below 105% of V_{REF} , the MPQ2178A exits this regulation period. If the dynamic regulation period cannot prevent V_{OUT} from increasing, and a 6.1V V_{IN} is detected, over-voltage protection (OVP) occurs. The MPQ2178A stops switching, and does not resume normal operation until V_{IN} drops below 6V.

Power Good (PG) Indicator

The MPQ2178A has one power good (PG) output to indicate normal operation after soft start. PG is the open drain of an internal MOSFET, for which the maximum $R_{DS(ON)}$ must remain below 400 Ω . PG can be connected to the input or an external voltage source through an external resistor (10k Ω to 100k Ω). After V_{IN} is applied, the MOSFET turns on and PG is pulled to GND before SS is ready. After V_{FB} reaches 90% of V_{REF} , PG is pulled high by the external voltage source. When V_{FB} drops to 85% of V_{REF} , the PG voltage (V_{PG}) is pulled to GND to indicate an output failure.

If V_{IN} and EN are not available and PG is pulled up by an external power supply, then PG will self-bias and assert. If a 100k Ω pull-up resistor is used, the voltage on the PG pin is below 0.7V.

APPLICATION INFORMATION

Setting the Output Voltage

The external resistor divider sets V_{OUT} for the adjustable output version of the MPQ2178A. Select a feedback resistor ($R1$) that reduces the V_{OUT} leakage current (typically between 10k Ω and 100k Ω). $R2$ can be calculated with Equation (3):

$$R2 = \frac{R1}{\frac{V_{OUT}}{0.6} - 1} \quad (3)$$

Figure 7 shows the feedback circuit.

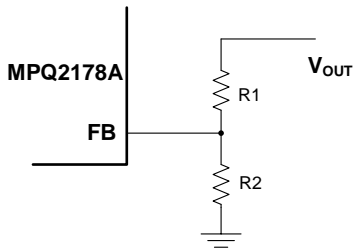

Figure 7: Feedback Network

Table 1 lists the recommended resistors value for common output voltages.

Table 1: Resistor Values for Common Output Voltages

V_{OUT} (V)	$R1$ (k Ω)	$R2$ (k Ω)
1.0	30.9 (1%)	47 (1%)
1.2	100 (1%)	100 (1%)
1.8	36 (1%)	18 (1%)
2.5	51 (1%)	16 (1%)
3.3	68 (1%)	15 (1%)

Frequency Scaling at Low Input Voltages

Under heavy-load conditions, the HS-FET voltage drops as t_{ON} increases, and the duty is extended. If the MPQ2178A reaches the minimum off time (t_{MIN_OFF}) while operating at a low input voltage under heavy-load conditions, the frequency scales down. To keep f_{SW} constant, a higher V_{OUT} requires a higher V_{IN} under heavy loads. For a 1.8V V_{OUT} , V_{IN} should exceed 2.9V. This ensures that f_{SW} stays above 2MHz at a 2A load. V_{IN} can be estimated with Equation (4):

$$V_{IN} = \frac{V_{OUT} + R_{DS(ON)-P} \times I_{OUT}}{1 - \frac{t_{MIN_OFF}}{400 \times 10^{-9}}} \quad (4)$$

Where the maximum t_{MIN_OFF} is 125ns. (7)

Note:

7) Guaranteed by design and bench characterization. Not tested in production.

Selecting the Inductor

A 0.47 μ H to 1.5 μ H inductor is recommended for most applications. Select an inductor with a DC resistance below 25m Ω to optimize efficiency.

High-frequency, switch-mode power supplies with magnetic devices such as the MPQ2178A can have strong electromagnetic interference (EMI). Avoid using unshielded power inductors, as they provide poor magnetic shielding. Shielded inductors, such as metal alloy or multilayer chip power inductors, are recommended because they effectively reduce EMI.

For most designs, the inductance (L_1) can be estimated with Equation (5):

$$L_1 = \frac{V_{OUT} \times (V_{IN} - V_{OUT})}{V_{IN} \times \Delta I_L \times f_{SW}} \quad (5)$$

Where ΔI_L is the inductor ripple current.

Choose an inductor ripple current that is approximately 30% of the maximum load current. The maximum inductor peak current ($I_{L(MAX)}$) can be calculated with Equation (6):

$$I_{L(MAX)} = I_{LOAD} + \frac{\Delta I_L}{2} \quad (6)$$

Selecting the Input Capacitor

The step-down converter has a discontinuous input current, and requires a capacitor to supply AC current to the converter while maintaining the DC input voltage. Use low-ESR capacitors for the best performance. Ceramic capacitors with X5R or X7R dielectrics are highly recommended because of their low ESR and small temperature coefficients. For most applications, a 10 μ F capacitor is sufficient. Higher output voltages may require a 22 μ F capacitor to increase system stability.

The input capacitor ($C1$) requires an adequate ripple current rating because it absorbs the input switching current.

Estimate the RMS current in the input capacitor with Equation (7):

$$I_{C1} = I_{LOAD} \times \sqrt{\frac{V_{OUT}}{V_{IN}} \times \left(1 - \frac{V_{OUT}}{V_{IN}}\right)} \quad (7)$$

The worst-case condition occurs at $V_{IN} = 2 \times V_{OUT}$, calculated with Equation (8):

$$I_{C1} = \frac{I_{LOAD}}{2} \quad (8)$$

For simplification, choose an input capacitor with an RMS current rating greater than half of the maximum load current.

C1 can be an electrolytic, tantalum, or ceramic capacitor. When using electrolytic or tantalum capacitors, add a small, high-quality, 0.1µF ceramic capacitor as close to the IC as possible. When using ceramic capacitors, ensure that they have enough capacitance to prevent an excessive input voltage ripple (ΔV_{IN}) at the input. ΔV_{IN} can be estimated with Equation (9):

$$\Delta V_{IN} = \frac{I_{LOAD}}{f_{SW} \times C1} \times \frac{V_{OUT}}{V_{IN}} \times \left(1 - \frac{V_{OUT}}{V_{IN}}\right) \quad (9)$$

Selecting the Output Capacitor

The output capacitor (C2) stabilizes the DC output voltage. Ceramic capacitors are recommended. Low-ESR capacitors are ideal because they effectively limit the output voltage ripple (ΔV_{OUT}). Estimate ΔV_{OUT} with Equation (10):

$$\Delta V_{OUT} = \frac{V_{OUT}}{f_{SW} \times L_1} \times \left(1 - \frac{V_{OUT}}{V_{IN}}\right) \times \left(R_{ESR} + \frac{1}{8 \times f_{SW} \times C2}\right) \quad (10)$$

Where L_1 is the inductance, and R_{ESR} is the equivalent series resistance (ESR) of the output capacitor.

When using ceramic capacitors, the capacitance dominates the impedance at the switching frequency and causes the majority of the output voltage ripple.

For simplification, ΔV_{OUT} can be estimated with Equation (11):

$$\Delta V_{OUT} = \frac{V_{OUT}}{8 \times f_{SW}^2 \times L_1 \times C2} \times \left(1 - \frac{V_{OUT}}{V_{IN}}\right) \quad (11)$$

Ceramic capacitors with X7R or X5R dielectrics are highly recommended because of their low ESR and small temperature coefficients.

For tantalum or electrolytic capacitors, the ESR dominates the impedance at the switching frequency. For simplification, ΔV_{OUT} can be estimated with Equation (12):

$$\Delta V_{OUT} = \frac{V_{OUT}}{f_{SW} \times L_1} \times \left(1 - \frac{V_{OUT}}{V_{IN}}\right) \times R_{ESR} \quad (12)$$

The characteristics of the output capacitor also affect the stability of the regulation system.

Output Discharge Blocking

When the device is disabled, an internal resistive discharge path from the OUT pin to GND is enabled to discharge the output capacitor (C2). The discharge path can be blocked by adding an external capacitor between the output and the OUT pin (see Figure 8).

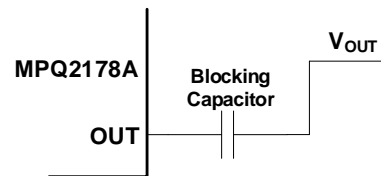

Figure 8: Circuit with V_{OUT} Discharge Blocking Capacitor

To avoid influencing the loop and load transient, the blocking capacitor should be at least 10nF. Larger-value blocking capacitors do not impact loop performance, but a larger-value capacitor is not required and may not be as cost effective. A capacitor between 10nF and 100nF is recommended.

PCB Layout Guidelines

Efficient PCB layout is critical for proper function. Poor layout design can result in suboptimal line or load regulation and stability issues. For the best results, refer to Figure 9 and follow the guidelines below:

1. Place the high-current paths (GND, VIN, and SW) very close to the device with short, direct, and wide traces.
2. Place the input capacitor (C1) as close as possible to the VIN and GND pins.
3. Place the GND output capacitor close the GND pins.
4. For the adjustable output version, place the external feedback resistors next to the FB pin.
5. Keep the switching node (SW) short, and route it away from the feedback network.
6. Keep the V_{OUT} sense line as short as possible, and place it as far away from the power inductor as possible. This sense line must not surround the inductor or be close to SW.

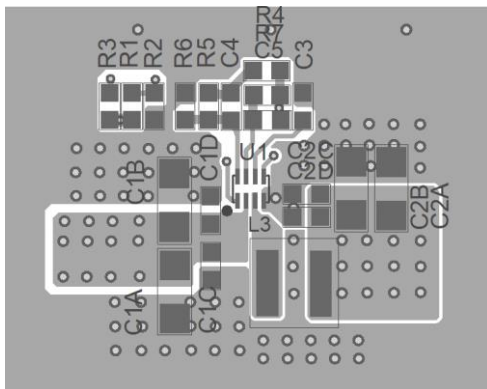

Top Layer

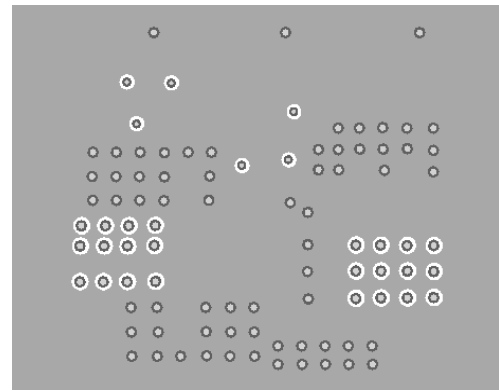

Mid-Layer 1

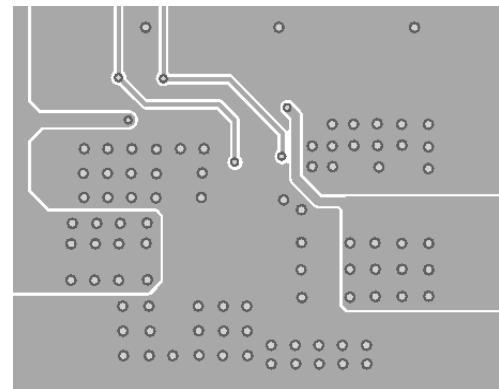

Mid-Layer 2

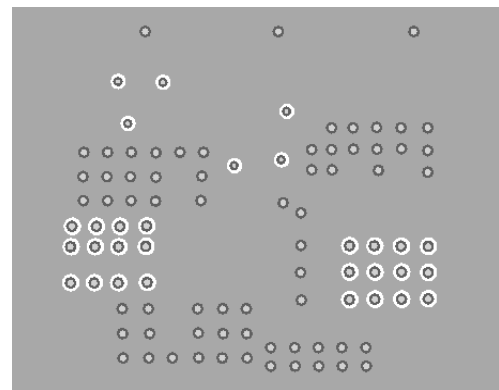

Bottom Layer

Figure 9: Recommended PCB Layout

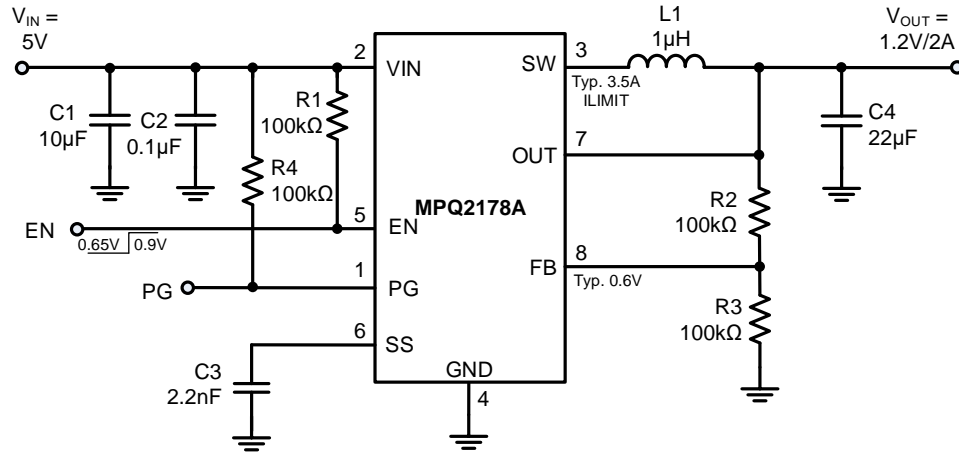
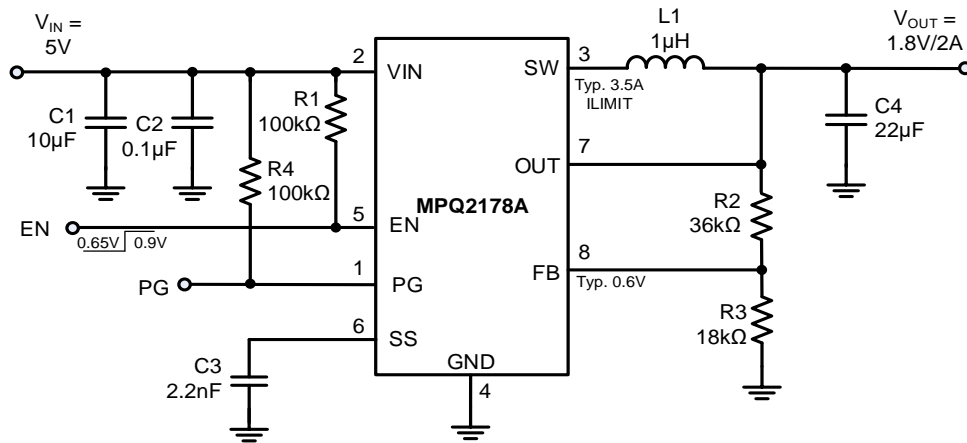
TYPICAL APPLICATION CIRCUITS

Figure 10: 1.2V Output Application Circuit for the MPQ2178A

Figure 11: 1.8V Output Application Circuit for the MPQ2178A

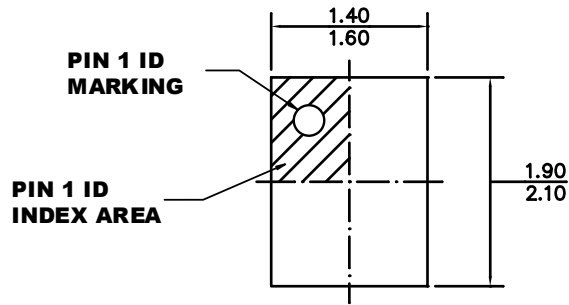
PACKAGE INFORMATION

QFN-8 (1.5mmx2mm) Wettable Flank

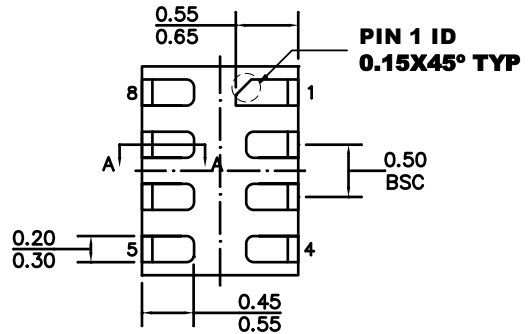

TOP VIEW



BOTTOM VIEW

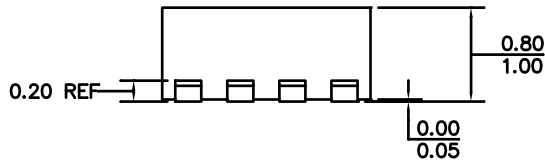

SIDE VIEW

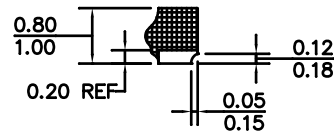

SECTION A-A

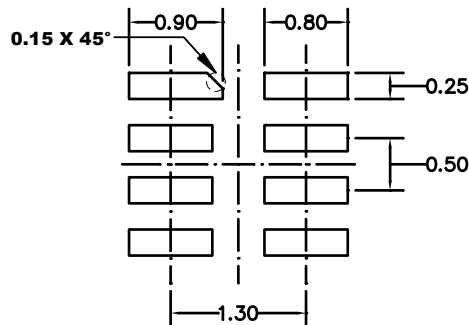

RECOMMENDED LAND PATTERN

NOTE:

- 1) THE LEAD SIDE IS WETTABLE.
- 2) ALL DIMENSIONS ARE IN MILLIMETERS.
- 3) LEAD COPLANARITY SHALL BE 0.08 MILLIMETERS MAX.
- 4) JEDEC REFERENCE IS MO-220.
- 5) DRAWING IS NOT TO SCALE.

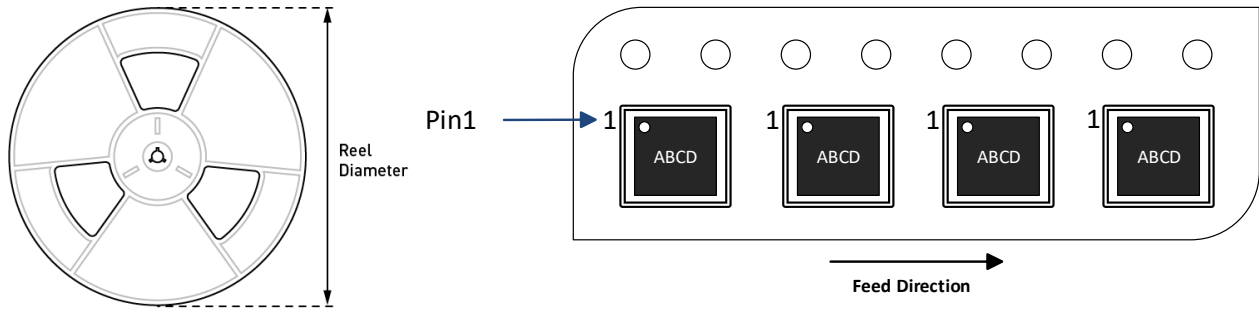
CARRIER INFORMATION

Part Number	Package Description	Quantity/ Reel	Quantity/ Tube	Quantity/ Tube	Reel Diameter	Carrier Tape Width	Carrier Tape Pitch
MPQ2178AGQHE-AEC1-Z	QFN-8 (1.5mmx2mm)	5000	N/A	N/A	13in	8mm	4mm

REVISION HISTORY

Revision #	Revision Date	Description	Pages Updated
1.0	07/01/2021	Initial Release	-

Notice: The information in this document is subject to change without notice. Please contact MPS for current specifications. Users should warrant and guarantee that third-party Intellectual Property rights are not infringed upon when integrating MPS products into any application. MPS will not assume any legal responsibility for any said applications.