

# 1200V XPT™ Gen 4 IGBT

# IXYK110N120C4

High Speed IGBT for up to 20-50kHz Switching

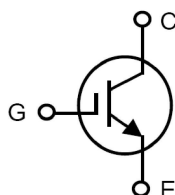

$$V_{CES} = 1200V$$

$$I_{C110} = 110A$$

$$V_{CE(sat)} \leq 2.40V$$

$$t_{fi(typ)} = 37ns$$

| Symbol              | Test Conditions   | Maximum Ratings                       |            |
|---------------------|---|---------------------------------------|------------|
| $V_{CES}$           | $T_J = 25^\circ C$ to $175^\circ C$   | 1200                                  | V          |
| $V_{CGR}$           | $T_J = 25^\circ C$ to $175^\circ C$ , $R_{GE} = 1M\Omega$                           | 1200                                  | V          |
| $V_{GES}$           | Continuous  | $\pm 20$                              | V          |
| $V_{GEM}$           | Transient   | $\pm 30$                              | V          |
| $I_{C25}$           | $T_C = 25^\circ C$ (Chip Capability)  | 310                                   | A          |
| $I_{LRMS}$          | Terminal Current Limit  | 160                                   | A          |
| $I_{C110}$          | $T_C = 110^\circ C$   | 110                                   | A          |
| $I_{CM}$            | $T_C = 25^\circ C$ , 1ms  | 740                                   | A          |
| <b>SSOA (RBSOA)</b> | $V_{GE} = 15V$ , $T_{VJ} = 150^\circ C$ , $R_G = 2\Omega$<br>Clamped Inductive Load | $I_{CM} = 220$<br>$0.8 \cdot V_{CES}$ | A<br>V     |
| $P_C$               | $T_C = 25^\circ C$  | 1360                                  | W          |
| $T_J$               |   | -55 ... +175                          | $^\circ C$ |
| $T_{JM}$            |   | 175                                   | $^\circ C$ |
| $T_{stg}$           |   | -55 ... +175                          | $^\circ C$ |
| $T_L$               | Maximum Lead Temperature for Soldering  | 300                                   | $^\circ C$ |
| $T_{SOLD}$          | 1.6 mm (0.062 in.) from Case for 10s  | 260                                   | $^\circ C$ |
| $F_C$               | Mounting Force  | 1.13 / 10                             | Nm/lb.in   |
| <b>Weight</b>       |   | 10                                    | g          |

TO-264 (IXYK)

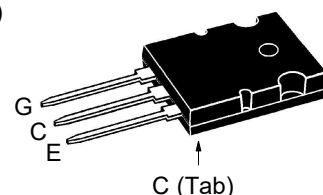

G = Gate                      E = Emitter  
C = Collector                Tab = Collector

## Features

- Optimized for Low Switching Losses
- Positive Thermal Coefficient of  $V_{ce(sat)}$
- International Standard Package

## Advantages

- High Power Density
- Low Gate Drive Requirement

## Applications

- Power Inverters
- UPS
- Motor Drives
- SMPS
- PFC Circuits
- Battery Chargers
- Welding Machines
- Lamp Ballasts

| Symbol        | Test Conditions<br>( $T_J = 25^\circ C$ , Unless Otherwise Specified) | Characteristic Values |              |                      |
|---------------|---|-----------------------|--------------|----------------------|
|               |   | Min.                  | Typ.         | Max.                 |
| $BV_{CES}$    | $I_C = 250\mu A$ , $V_{GE} = 0V$                                      | 1200                  |              | V                    |
| $V_{GE(th)}$  | $I_C = 3mA$ , $V_{CE} = V_{GE}$                                       | 4.5                   |              | 6.5 V                |
| $I_{CES}$     | $V_{CE} = V_{CES}$ , $V_{GE} = 0V$<br>$T_J = 150^\circ C$             |                       |              | 25 $\mu A$<br>1.5 mA |
| $I_{GES}$     | $V_{CE} = 0V$ , $V_{GE} = \pm 20V$                                    |                       |              | $\pm 100$ nA         |
| $V_{CE(sat)}$ | $I_C = I_{C110}$ , $V_{GE} = 15V$ , Note 1<br>$T_J = 150^\circ C$     |                       | 1.90<br>2.27 | 2.40 V<br>V          |

| Symbol Test Conditions<br>( $T_J = 25^\circ\text{C}$ Unless Otherwise Specified) |   | Characteristic Values |                         |      |
|--|---|-----------------------|-------------------------|------|
|  |   | Min.                  | Typ.                    | Max. |
| $g_{fs}$   | $I_C = 60\text{A}, V_{CE} = 10\text{V}, \text{Note 1}$  | 40                    | 68                      | S    |
| $C_{ies}$  | $V_{CE} = 25\text{V}, V_{GE} = 0\text{V}, f = 1\text{MHz}$  |                       | 5420                    | pF   |
| $C_{oes}$  |   |                       | 335                     | pF   |
| $C_{res}$  |   |                       | 220                     | pF   |
| $Q_{g(on)}$  | $I_C = I_{C110}, V_{GE} = 15\text{V}, V_{CE} = 0.5 \cdot V_{CES}$   |                       | 330                     | nC   |
| $Q_{ge}$   |   |                       | 55                      | nC   |
| $Q_{gc}$   |   |                       | 138                     | nC   |
| $t_{d(on)}$  | <b>Inductive load, <math>T_J = 25^\circ\text{C}</math></b><br>$I_C = 50\text{A}, V_{GE} = 15\text{V}$<br>$V_{CE} = 0.5 \cdot V_{CES}, R_G = 2\Omega$<br>Note 2  |                       | 40                      | ns   |
| $t_{ri}$   |   |                       | 48                      | ns   |
| $E_{on}$   |   |                       | 3.6                     | mJ   |
| $t_{d(off)}$   |   |                       | 320                     | ns   |
| $t_{fi}$   |   |                       | 37                      | ns   |
| $E_{off}$  |   |                       | 1.9                     | mJ   |
| $t_{d(on)}$  | <b>Inductive load, <math>T_J = 150^\circ\text{C}</math></b><br>$I_C = 50\text{A}, V_{GE} = 15\text{V}$<br>$V_{CE} = 0.5 \cdot V_{CES}, R_G = 2\Omega$<br>Note 2 |                       | 36                      | ns   |
| $t_{ri}$   |   |                       | 37                      | ns   |
| $E_{on}$   |   |                       | 5.3                     | mJ   |
| $t_{d(off)}$   |   |                       | 326                     | ns   |
| $t_{fi}$   |   |                       | 90                      | ns   |
| $E_{off}$  |   |                       | 3.2                     | mJ   |
| $R_{thJC}$   |   |                       | 0.11 $^\circ\text{C/W}$ |      |
| $R_{thCS}$   |   | 0.15                  | $^\circ\text{C/W}$      |      |

**Notes:**

1. Pulse test,  $t \leq 300\mu\text{s}$ , duty cycle,  $d \leq 2\%$ .
2. Switching times & energy losses may increase for higher  $V_{CE}$  (clamp),  $T_J$  or  $R_G$ .

Littelfuse reserves the right to change limits, test conditions, and dimensions.

|   |           |           |           |           |              |              |              |              |              |             |
|---|-----------|-----------|-----------|-----------|--------------|--------------|--------------|--------------|--------------|-------------|
| IXYS MOSFETs and IGBTs are covered            | 4,835,592 | 4,931,844 | 5,049,961 | 5,237,481 | 6,162,665    | 6,404,065 B1 | 6,683,344    | 6,727,585    | 7,005,734 B2 | 7,157,338B2 |
| by one or more of the following U.S. patents: | 4,860,072 | 5,017,508 | 5,063,307 | 5,381,025 | 6,259,123 B1 | 6,534,343    | 6,710,405 B2 | 6,759,692    | 7,063,975 B2 |             |
|   | 4,881,106 | 5,034,796 | 5,187,117 | 5,486,715 | 6,306,728 B1 | 6,583,505    | 6,710,463    | 6,771,478 B2 | 7,071,537    |             |

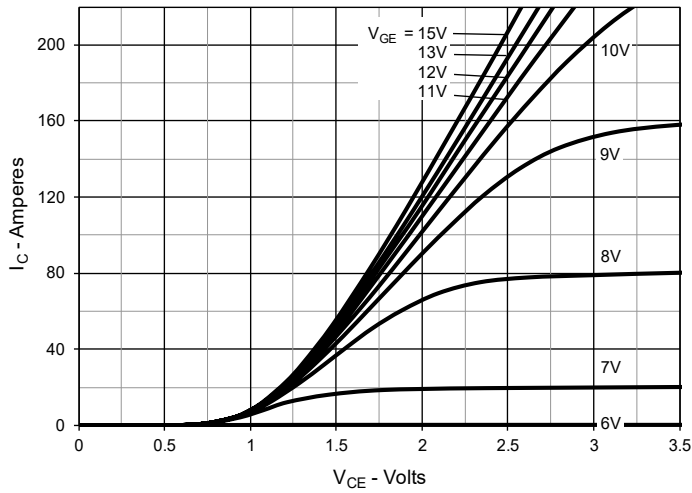
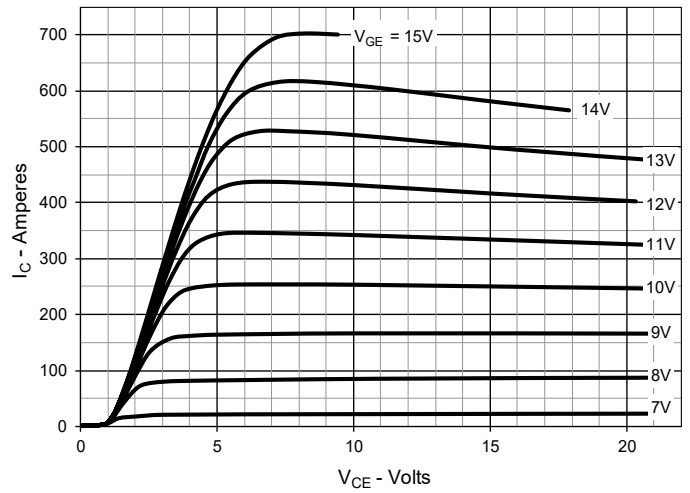
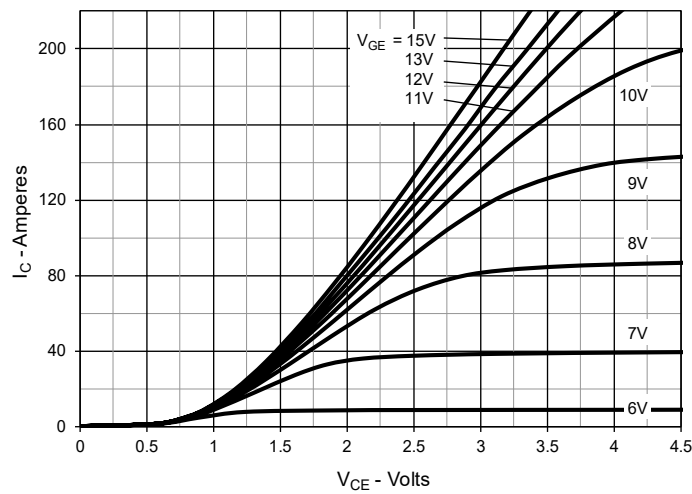
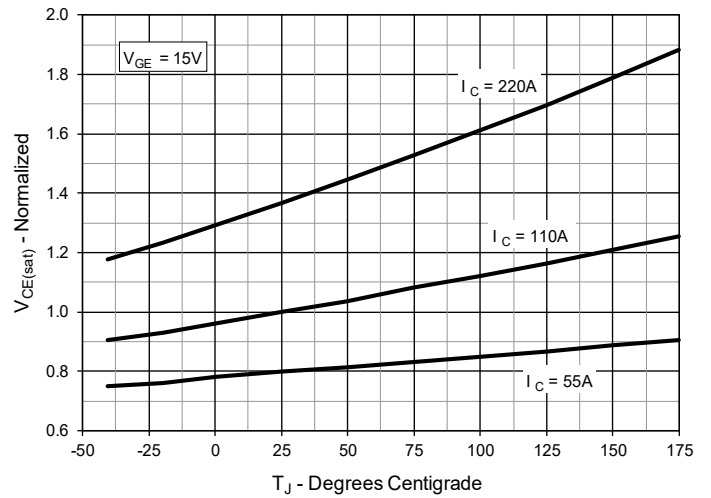
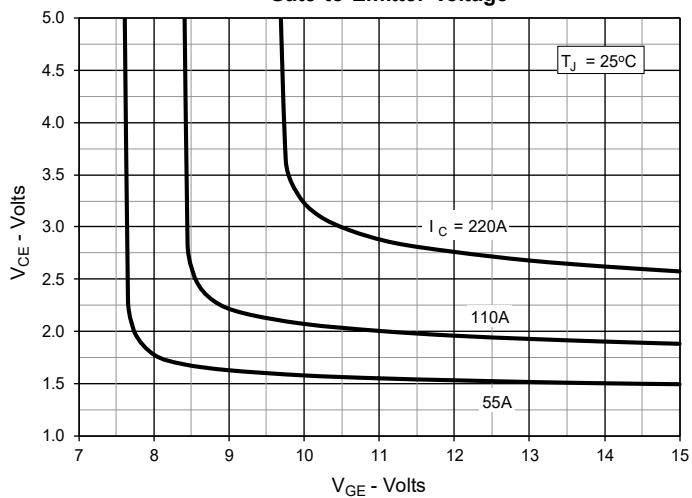
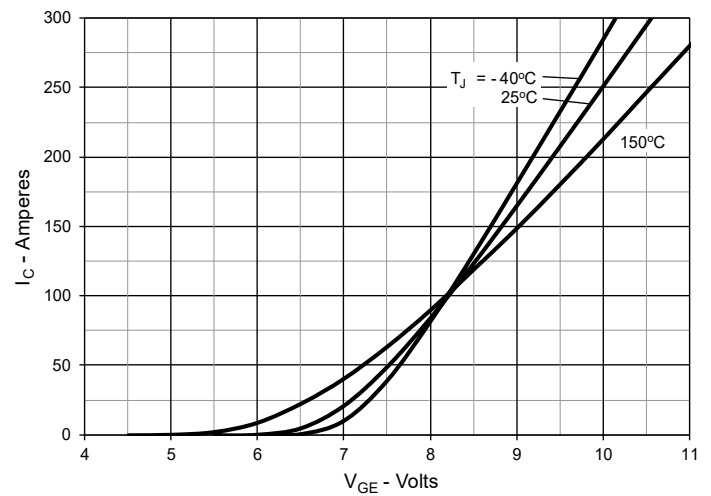
**Fig. 1. Output Characteristics @  $T_J = 25^\circ\text{C}$** 

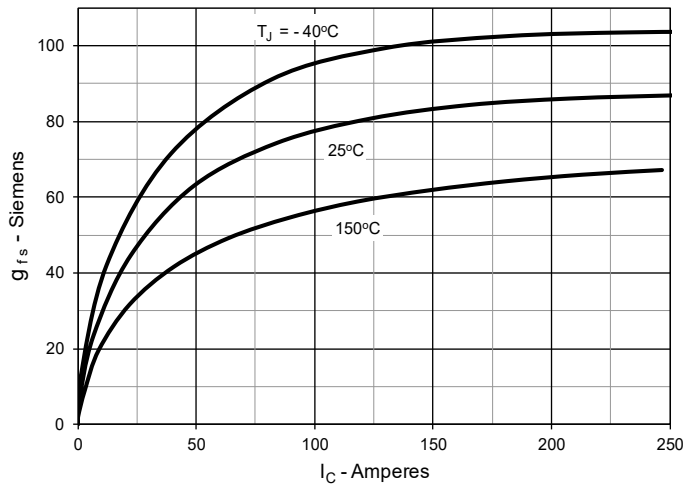
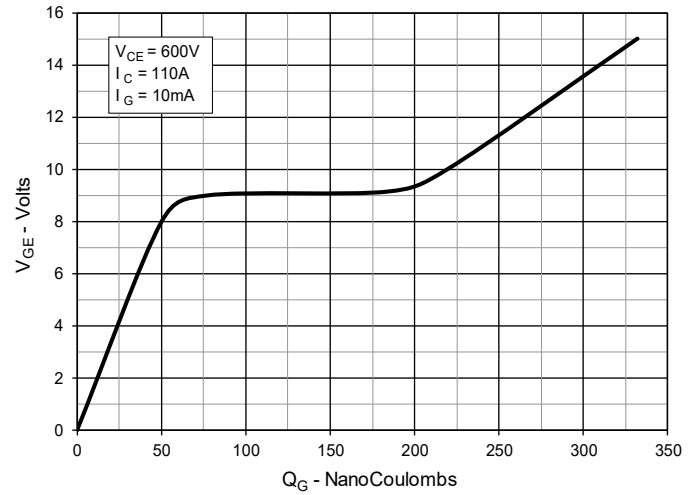
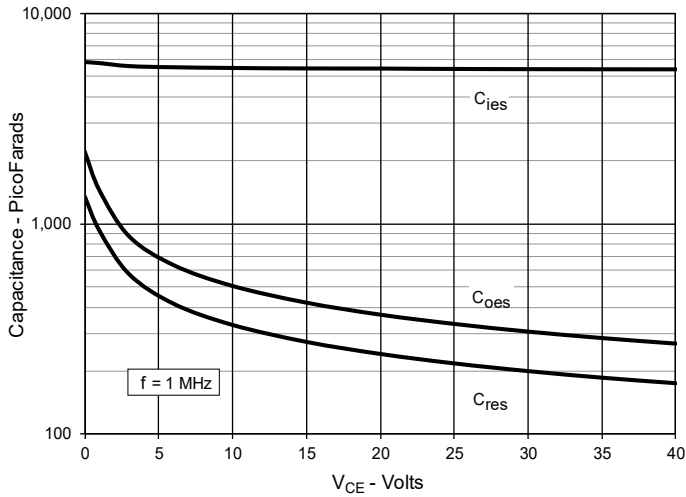
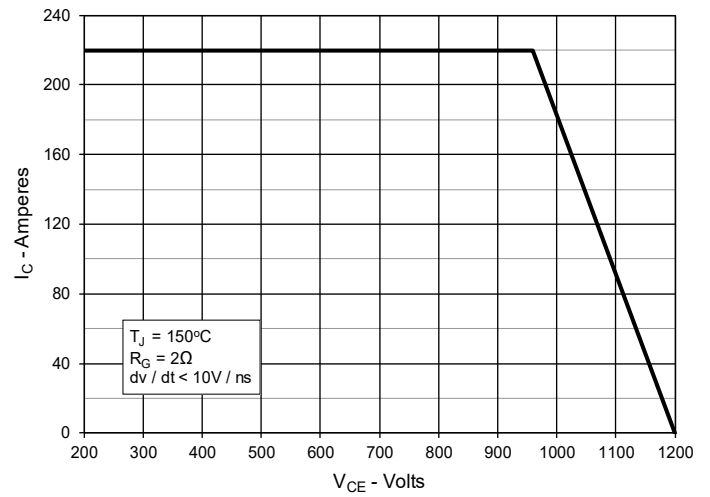
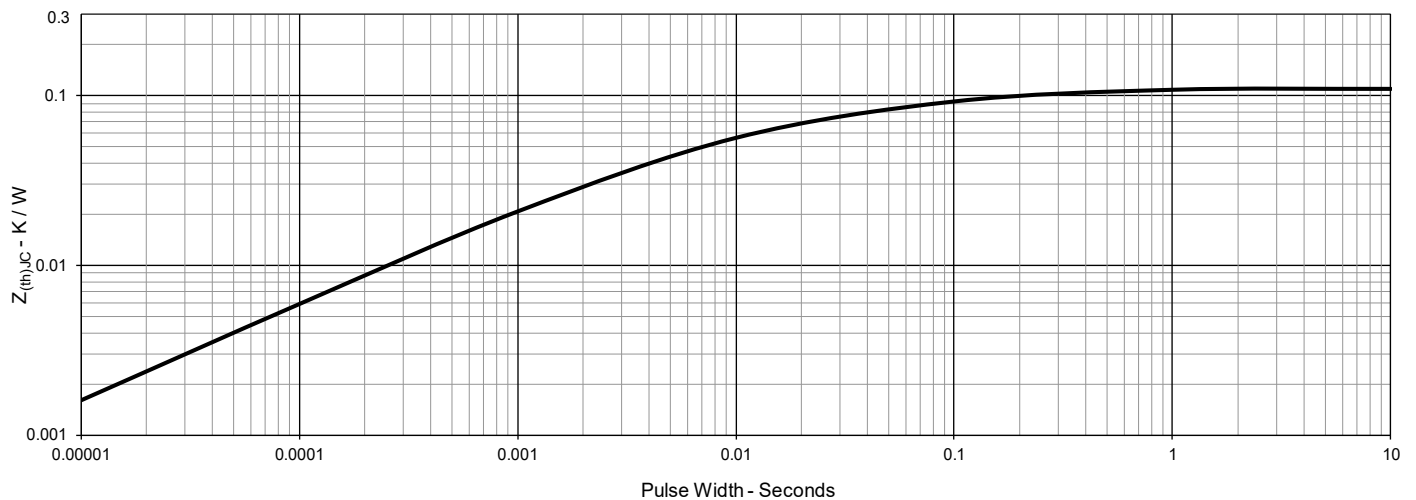
**Fig. 2. Extended Output Characteristics @  $T_J = 25^\circ\text{C}$** 

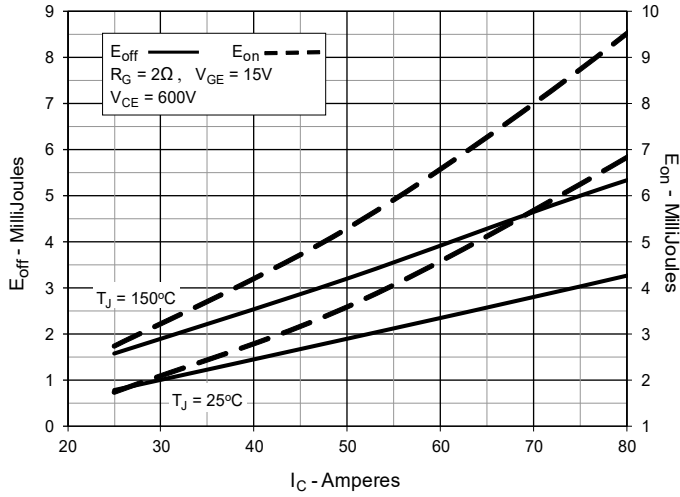
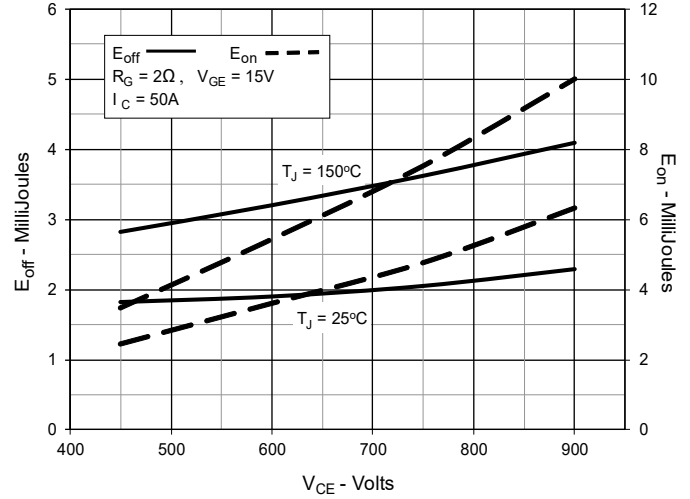
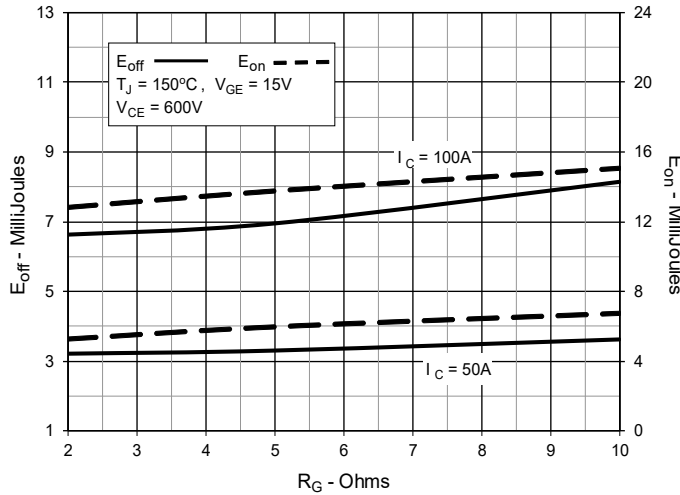
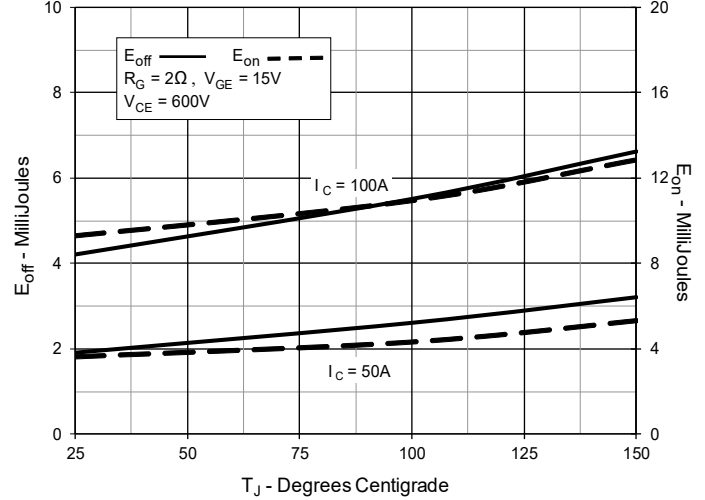
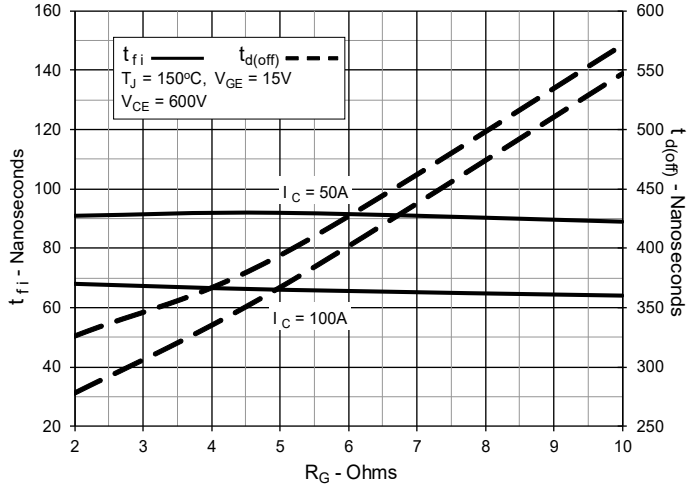
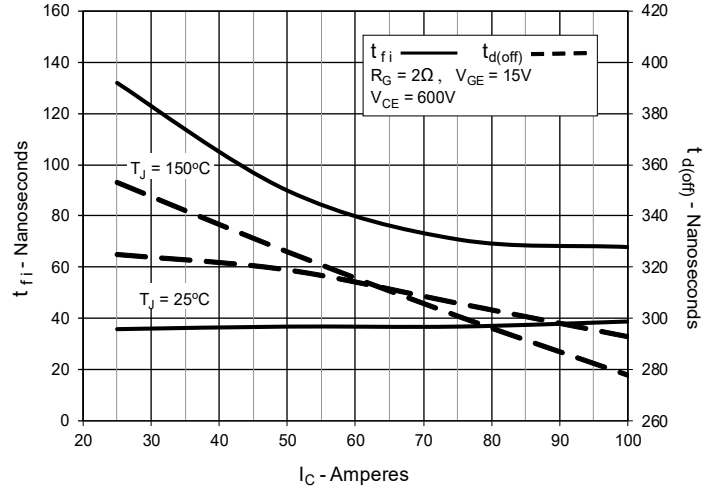
**Fig. 3. Output Characteristics @  $T_J = 150^\circ\text{C}$** 

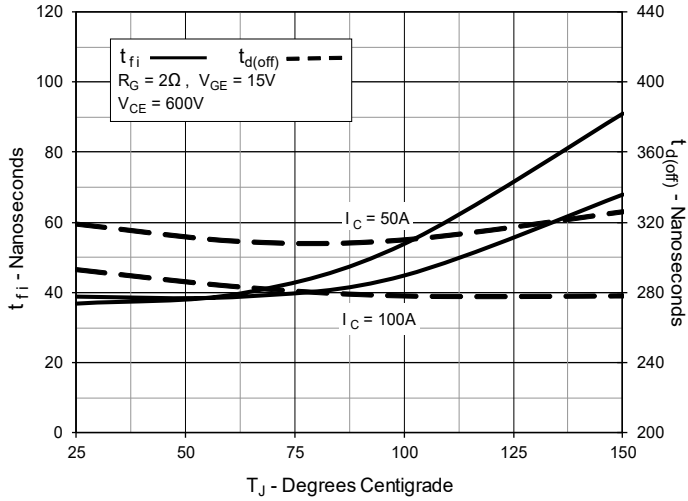
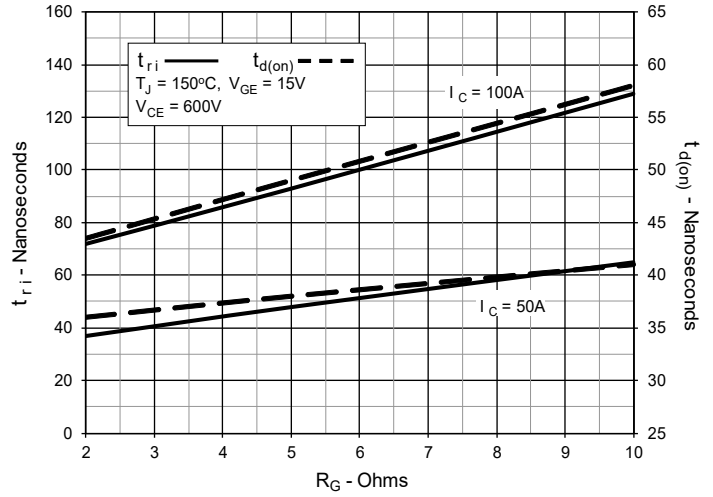
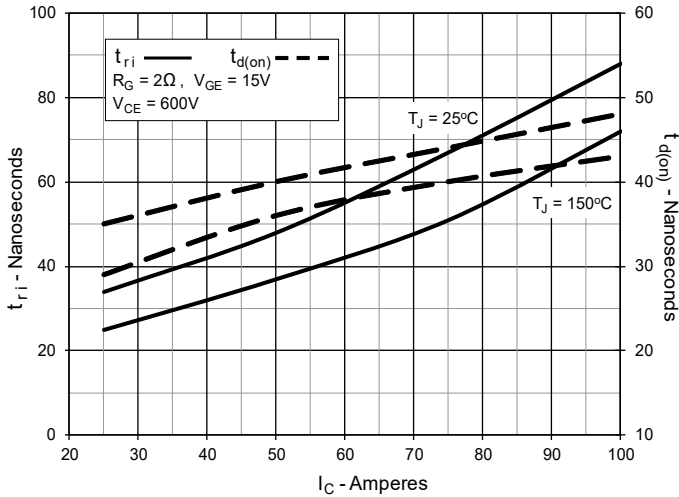
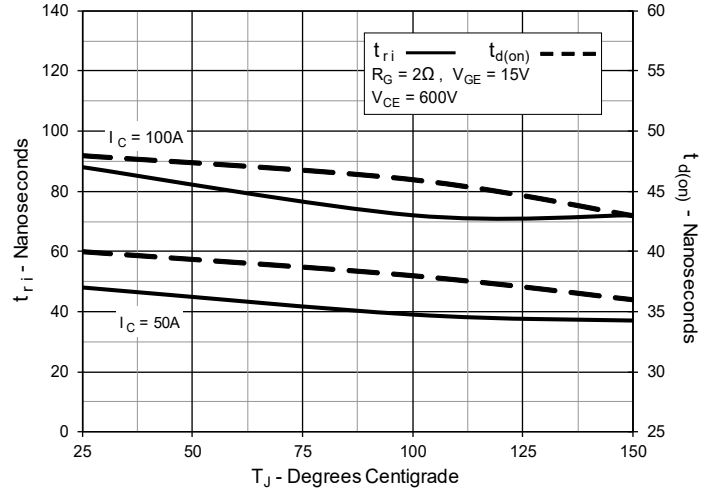
**Fig. 4. Dependence of  $V_{CE(sat)}$  on Junction Temperature**

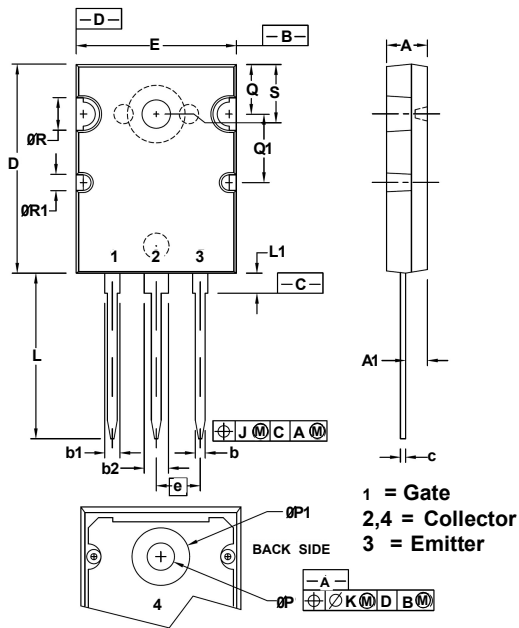
**Fig. 5. Collector-to-Emitter Voltage vs. Gate-to-Emitter Voltage**

**Fig. 6. Input Admittance**

**Fig. 7. Transconductance**

**Fig. 8. Gate Charge**

**Fig. 9. Capacitance**

**Fig. 10. Reverse-Bias Safe Operating Area**

**Fig. 11. Maximum Transient Thermal Impedance**

**Fig. 12. Inductive Switching Energy Loss vs. Collector Current**

**Fig. 13. Inductive Switching Energy Loss vs. Collector-Emitter Voltage**

**Fig. 14. Inductive Switching Energy Loss vs. Gate Resistance**

**Fig. 15. Inductive Switching Energy Loss vs. Junction Temperature**

**Fig. 16. Inductive Turn-off Switching Times vs. Gate Resistance**

**Fig. 17. Inductive Turn-off Switching Times vs. Collector Current**

**Fig. 18. Inductive Turn-off Switching Times vs. Junction Temperature**

**Fig. 19. Inductive Turn-on Switching Times vs. Gate Resistance**

**Fig. 20. Inductive Turn-on Switching Times vs. Collector Current**

**Fig. 21. Inductive Turn-on Switching Times vs. Junction Temperature**

**TO-264 Outline**

| SYMBOL | INCHES  |       | MILLIMETERS |       |
|--------|---------|-------|-------------|-------|
|        | MIN     | MAX   | MIN         | MAX   |
| A      | .185    | .209  | 4.70        | 5.31  |
| A1     | .102    | .118  | 2.59        | 3.00  |
| b      | .037    | .055  | 0.94        | 1.40  |
| b1     | .087    | .102  | 2.21        | 2.59  |
| b2     | .110    | .126  | 2.79        | 3.20  |
| c      | .017    | .029  | 0.43        | 0.74  |
| D      | 1.007   | 1.047 | 25.58       | 26.59 |
| E      | .760    | .799  | 19.30       | 20.29 |
| e      | .215BSC |       | 5.46 BSC    |       |
| J      | .000    | .010  | 0.00        | 0.25  |
| K      | .000    | .010  | 0.00        | 0.25  |
| L      | .779    | .842  | 19.79       | 21.39 |
| L1     | .087    | .102  | 2.21        | 2.59  |
| ØP     | .122    | .138  | 3.10        | 3.51  |
| ØP1    | .270    | .290  | 6.86        | 7.37  |
| Q      | .240    | .256  | 6.10        | 6.50  |
| Q1     | .330    | .346  | 8.38        | 8.79  |
| ØR     | .155    | .187  | 3.94        | 4.75  |
| ØR1    | .085    | .093  | 2.16        | 2.36  |
| S      | .243    | .253  | 6.17        | 6.43  |