

Trench IGBT

Copack

$V_{CES} = 1200 \text{ V}$

$I_{C25} = 72 \text{ A}$

$V_{CE(sat)} = 2.05 \text{ V}$

Part number

ITF48IF1200HR

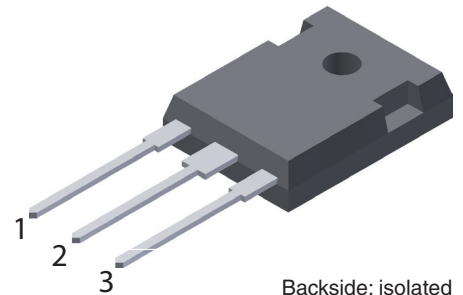

Backside: isolated

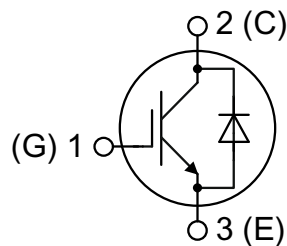

Features / Advantages:

- Easy paralleling due to the positive temperature coefficient of the on-state voltage
- Fast Trench IGBT
 - very low $V_{CE(sat)}$
 - short circuit rated for 10 μ sec.
 - very low gate charge
 - low EMI
 - square RBSOA @ $3x I_C$
- Sonic™ diode
 - fast and soft reverse recovery
 - low operating forward voltage

Applications:

- Solar inverter
- Medical equipment
- Uninterruptible power supply
- Air-conditioning system
- Welding equipment
- Switched-mode and resonant-mode power supplies
- Inductive heating, cookers
- Pumps, Fans

Package: ISO247

- Isolation Voltage: 3600 V~
- Industry standard outline
- RoHS compliant
- Epoxy meets UL 94V-0
- Soldering pins for PCB mounting
- Backside: DCB ceramic
- Reduced weight
- Advanced power cycling

Terms & Conditions of usage

The data contained in this product data sheet is exclusively intended for technically trained staff. The user will have to evaluate the suitability of the product for the intended application and the completeness of the product data with respect to his application. The specifications of our components may not be considered as an assurance of component characteristics. The information in the valid application- and assembly notes must be considered. Should you require product information in excess of the data given in this product data sheet or which concerns the specific application of your product, please contact the sales office, which is responsible for you. Due to technical requirements our product may contain dangerous substances. For information on the types in question please contact the sales office, which is responsible for you. Should you intend to use the product in aviation, in health or life endangering or life support applications, please notify. For any such application we urgently recommend

- to perform joint risk and quality assessments;
- the conclusion of quality agreements;
- to establish joint measures of an ongoing product survey, and that we may make delivery dependent on the realization of any such measures.

IGBT				Ratings		
Symbol	Definitions	Conditions	min.	typ.	max.	
V_{CE}	collector emitter voltage				1200	V
V_{GES}	max. DC gate voltage				±20	V
I_{C25}	collector current				72	A
I_{C80}					56	A
I_{C100}					48	A
P_{tot}	total power dissipation				390	W
$V_{CE(sat)}$	collector emitter saturation voltage	$I_C = 40\text{ A}; V_{GE} = 15\text{ V}$		2.05	2.40	V
				2.70		V
$V_{GE(th)}$	gate emitter threshold voltage	$I_C = 1.5\text{ mA}; V_{GE} = V_{CE}$	5.3	5.8	6.3	V
I_{CES}	collector emitter leakage current	$V_{CE} = V_{CES}; V_{GE} = 0\text{ V}$		1.5	0.25	mA
						mA
I_{GES}	gate emitter leakage current	$V_{GE} = \pm 20\text{ V}$			600	nA
Q_{Gon}	total gate charge	$V_{CE} = 600\text{ V}; V_{GE} = 0/15\text{ V}; I_C = 40\text{ A}$		175		nC
$t_{d(on)}$	turn-on delay time	inductive load $V_{CE} = 600\text{ V}; I_C = 40\text{ A}$ $V_{GE} = 0/15\text{ V}; R_G = 12\ \Omega$		26		ns
t_r	current rise time			26		ns
$t_{d(off)}$	turn-off delay time			350		ns
t_f	current fall time			110		ns
E_{on}	turn-on energy per pulse			3.0		mJ
E_{off}	turn-off energy per pulse			2.4		mJ
$E_{rec(off)}$	reverse recovery losses at turn-off			1.1		mJ
RBSOA	reverse bias safe operating area	$V_{GE} = 15\text{ V};$ $V_{CEmax} = 1200\text{ V}$			160	A
I_{CM}						
SCSOA	short circuit safe operation area	$V_{CE} = 600\text{ V}; V_{GE} = \pm 15\text{ V}$ $R_G = 12\ \Omega; \text{none repetitive}$			10	μs
t_{SC}	short circuit duration					
I_{SC}	short circuit current			140		A
R_{thJC}	thermal resistance junction to case				0.38	K/W
R_{thJH}	thermal resistance junction to heatsink	with heat transfer paste (IXYS test setup)		0.6		K/W

Diode						
V_{RRM}	max. repetitive reverse voltage				1200	V
I_{F25}	forward current				67	A
I_{F80}					50	A
I_{F100}					43	A
V_F	forward voltage	$I_F = 30\text{ A}$			2.20	V
				1.95		V
Q_{rr}	reverse recovery charge	$V_R = 600\text{ V}$ $-di_F/dt = -1800\text{ A}/\mu\text{s}$ $I_F = 40\text{ A}; V_{GE} = 0\text{ V}$		3.8		μC
I_{RM}	max. reverse recovery current			55		A
t_{rr}	reverse recovery time			250		ns
E_{rec}	reverse recovery losses			1.1		mJ
R_{thJC}	thermal resistance junction to case				0.7	K/W
R_{thJH}	thermal resistance junction to heatsink	with heat transfer paste (IXYS test setup)		1.1		K/W

Package ISO247				Ratings			
Symbol	Definitions	Conditions	min.	typ.	max.		
I_{RMS}	RMS current	per terminal			50	A	
T_{stg}	storage temperature		-40		150	°C	
T_{op}	operation temperature		-40		150	°C	
T_{VJ}	virtual junction temperature		-40		175	°C	
Weight				6		g	
M_D	mounting torque		0.8		1.2	Nm	
F_C	mounting force with clip		40		120	N	
$d_{Spp/App}$	creepage distance on surface /	terminal to terminal	2.7			mm	
$d_{Spb/Appb}$	striking distance through air	terminal to backside	4.1			mm	
V_{ISOL}	isolation voltage	t = 1 second t = 1 minute		3600 3000		V V	
			50/60 Hz; RMS; $I_{ISOL} < 1$ mA				

Product Marking

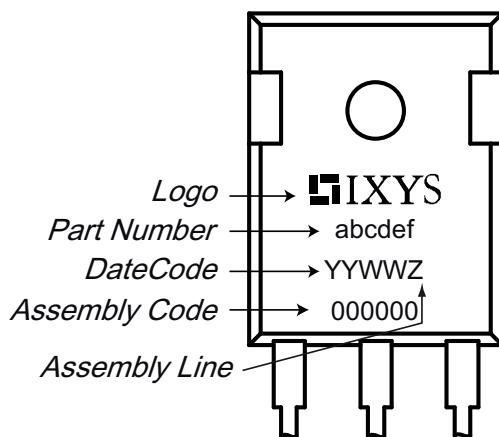

Part number

I = IGBT
 T = IGBT Trench
 F = Fast
 48 = Current Rating [A]
 IF = Copack
 1200 = Reverse Voltage [V]
 HR = ISO247 (3)

Ordering	Part Name	Marking on Product	Delivering Mode	Base Qty	Ordering Code
Standard	ITF48IF1200HR	ITF48IF1200HR	Tube	30	517181

Equivalent Circuits for Simulation *on die level $T_{VJ} = 175^{\circ}C$

		IGBT	Diode	
$V_{0\ max}$	threshold voltage	0.88	1.2	V
$R_{0\ max}$	slope resistance *	58	30	mΩ

Outlines ISO247

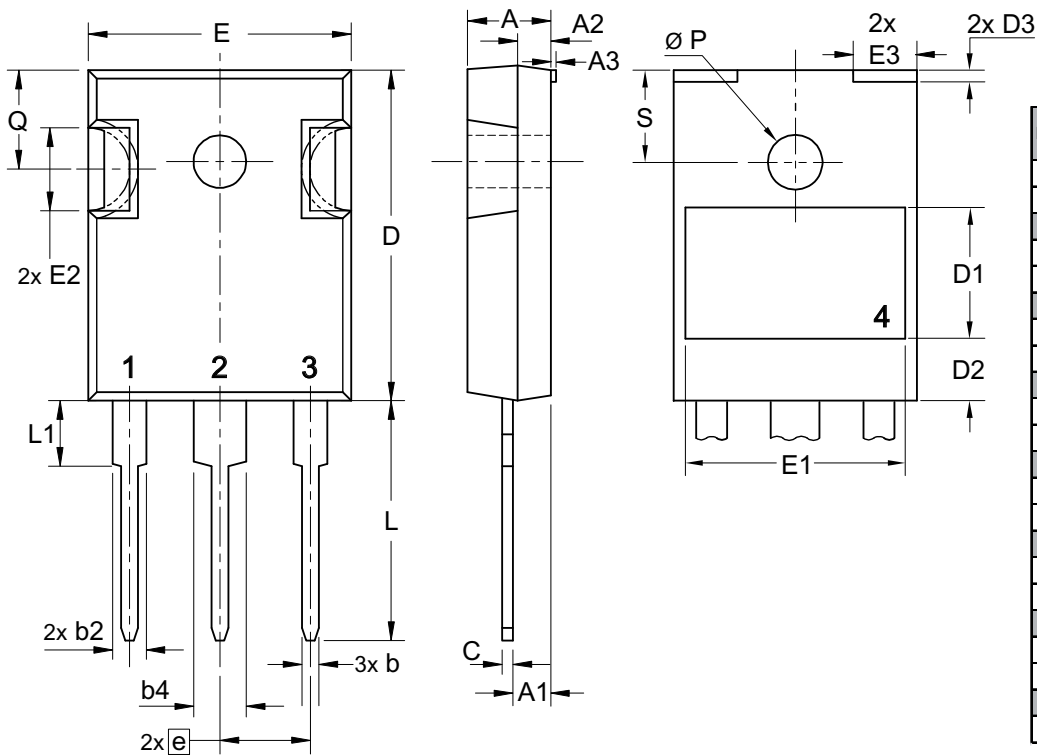

Dim.	Millimeter		Inches	
	min	max	min	max
A	4.70	5.30	0.185	0.209
A1	2.21	2.59	0.087	0.102
A2	1.50	2.49	0.059	0.098
A3	typ. 0.05		typ. 0.002	
b	0.99	1.40	0.039	0.055
b2	1.65	2.39	0.065	0.094
b4	2.59	3.43	0.102	0.135
c	0.38	0.89	0.015	0.035
D	20.79	21.45	0.819	0.844
D1	typ. 8.90		typ. 0.350	
D2	typ. 2.90		typ. 0.114	
D3	typ. 1.00		typ. 0.039	
E	15.49	16.24	0.610	0.639
E1	typ. 13.45		typ. 0.530	
E2	4.31	5.48	0.170	0.216
E3	typ. 4.00		typ. 0.157	
e	5.46 BSC		0.215 BSC	
L	19.80	20.30	0.780	0.799
L1	-	4.49	-	0.177
Ø P	3.55	3.65	0.140	0.144
Q	5.38	6.19	0.212	0.244
S	6.14	BSC	0.242	BSC

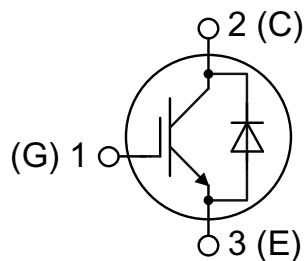

IGBT

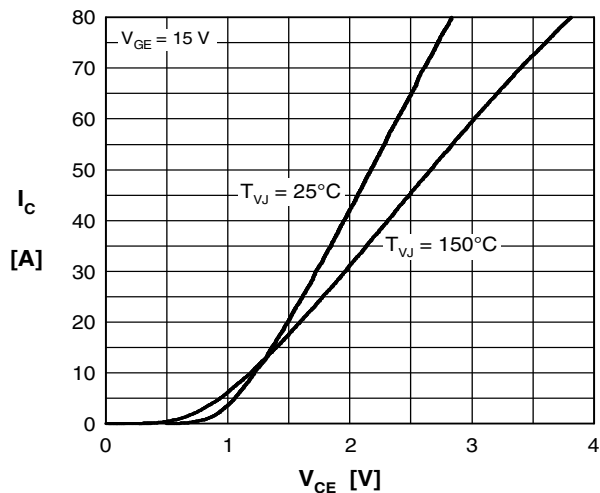

Fig. 1 Typ. output characteristics

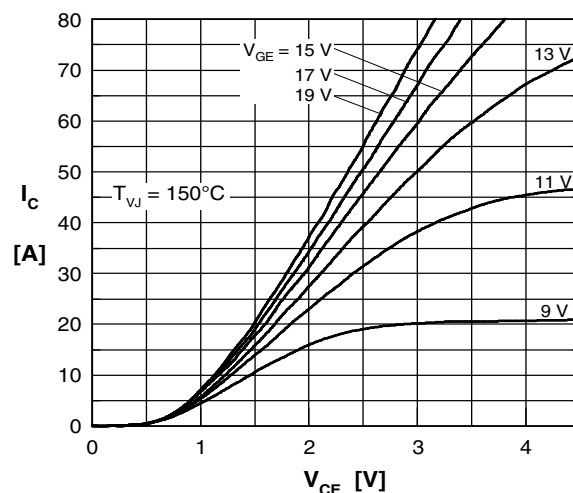

Fig. 2 Typ. output characteristics

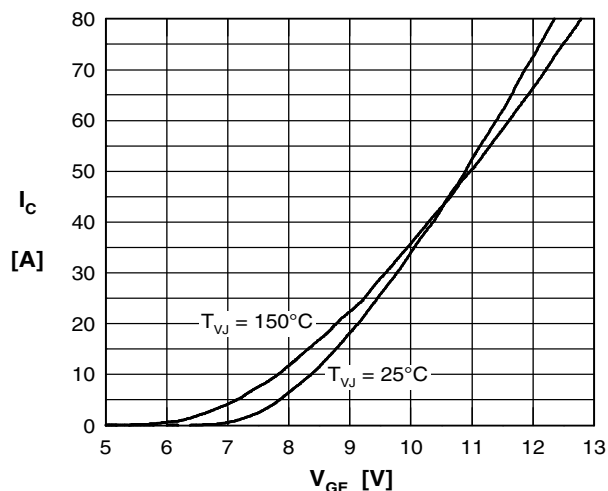

Fig. 3 Typ. transfer characteristics

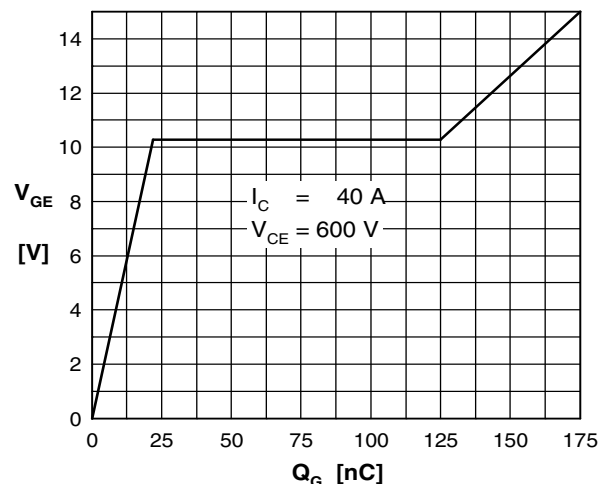

Fig. 4 Typ. turn-on gate charge

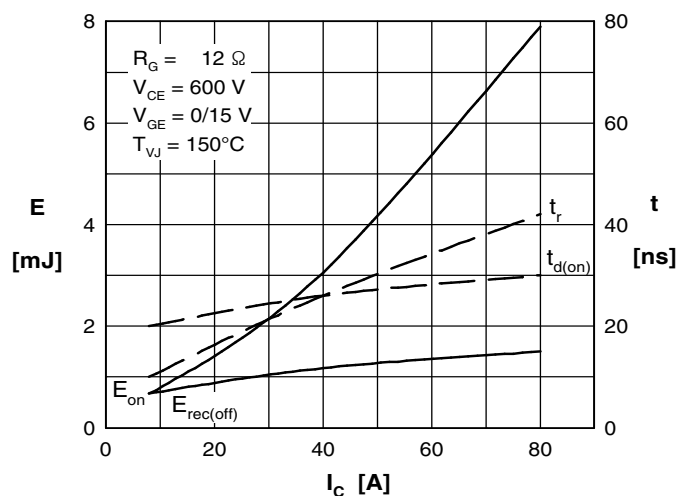

Fig. 5 Typ. turn-on energy & switching times versus collector current

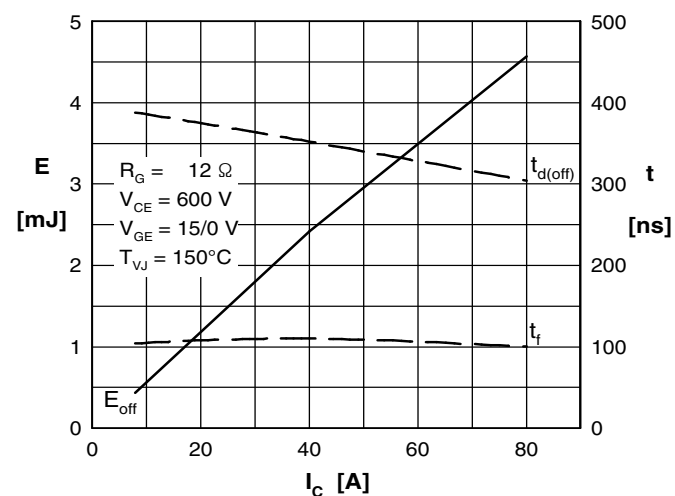

Fig. 6 Typ. turn-off energy & switching times versus collector current

IGBT

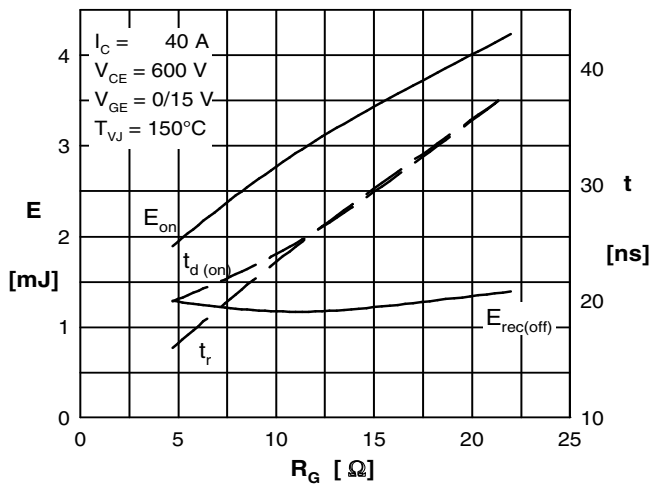

Fig. 7 Typ. turn-on energy and switching times versus gate resistor

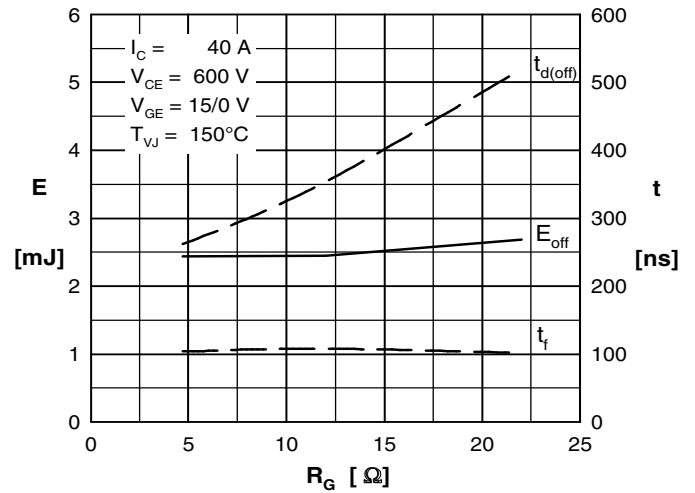

Fig. 8 Typ. turn-off energy and switching times versus gate resistor

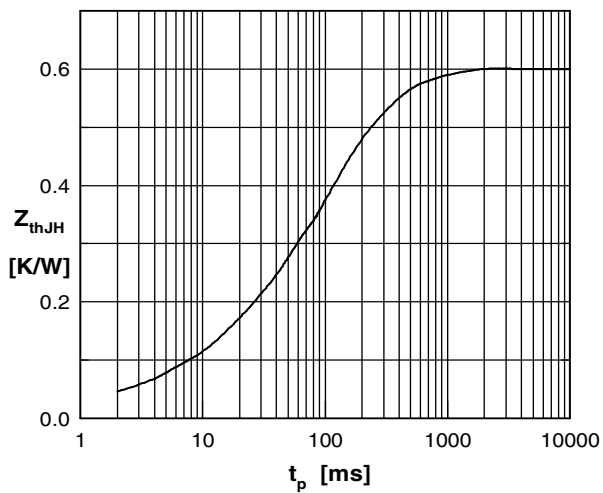

Fig. 9 Typ. transient thermal impedance

DIODE

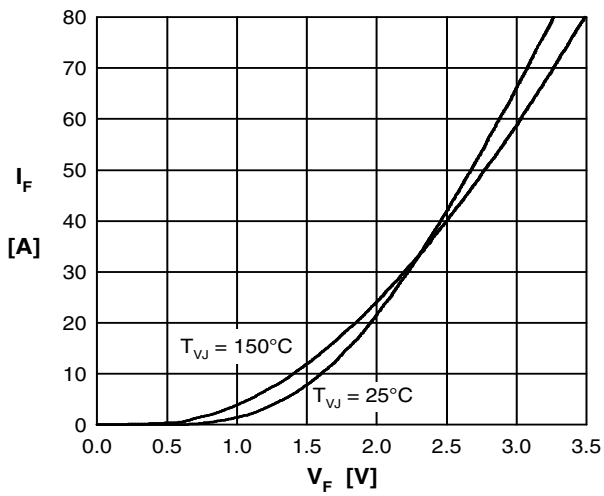

Fig. 10 Typ. forward characteristics

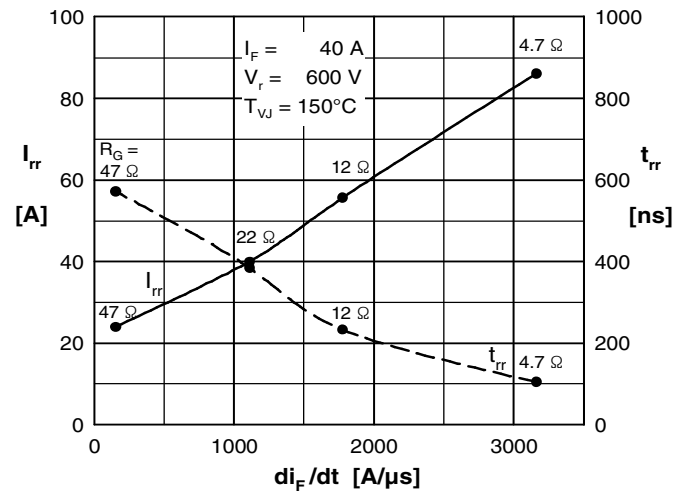

Fig. 11 Typ. reverse recovery characteristics

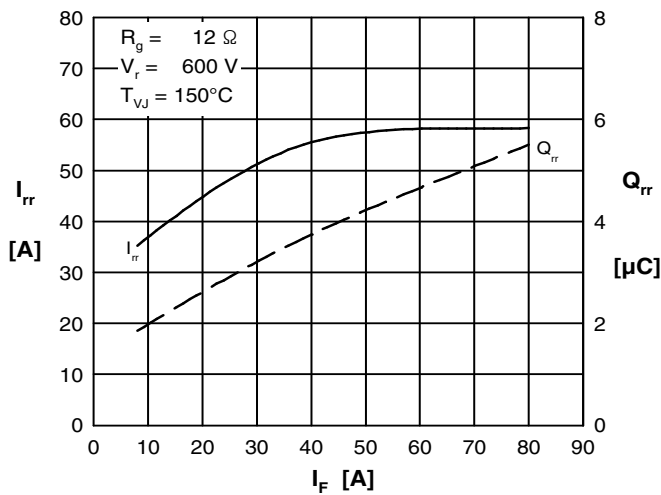

Fig. 12 Typ. reverse recovery characteristics

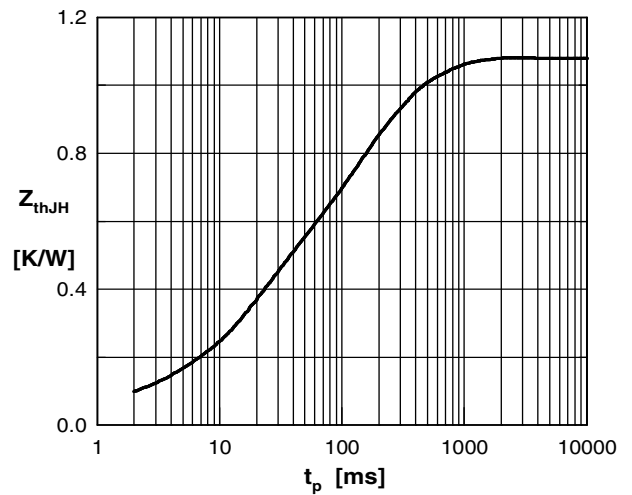

Fig. 13 Typ. transient thermal impedance