

PAGE 1/2	ISSUE 09-12-19A	SERIES COUPLER	PART NUMBER R433833700
----------	-----------------	-------------------	------------------------

Scale 2 : 1

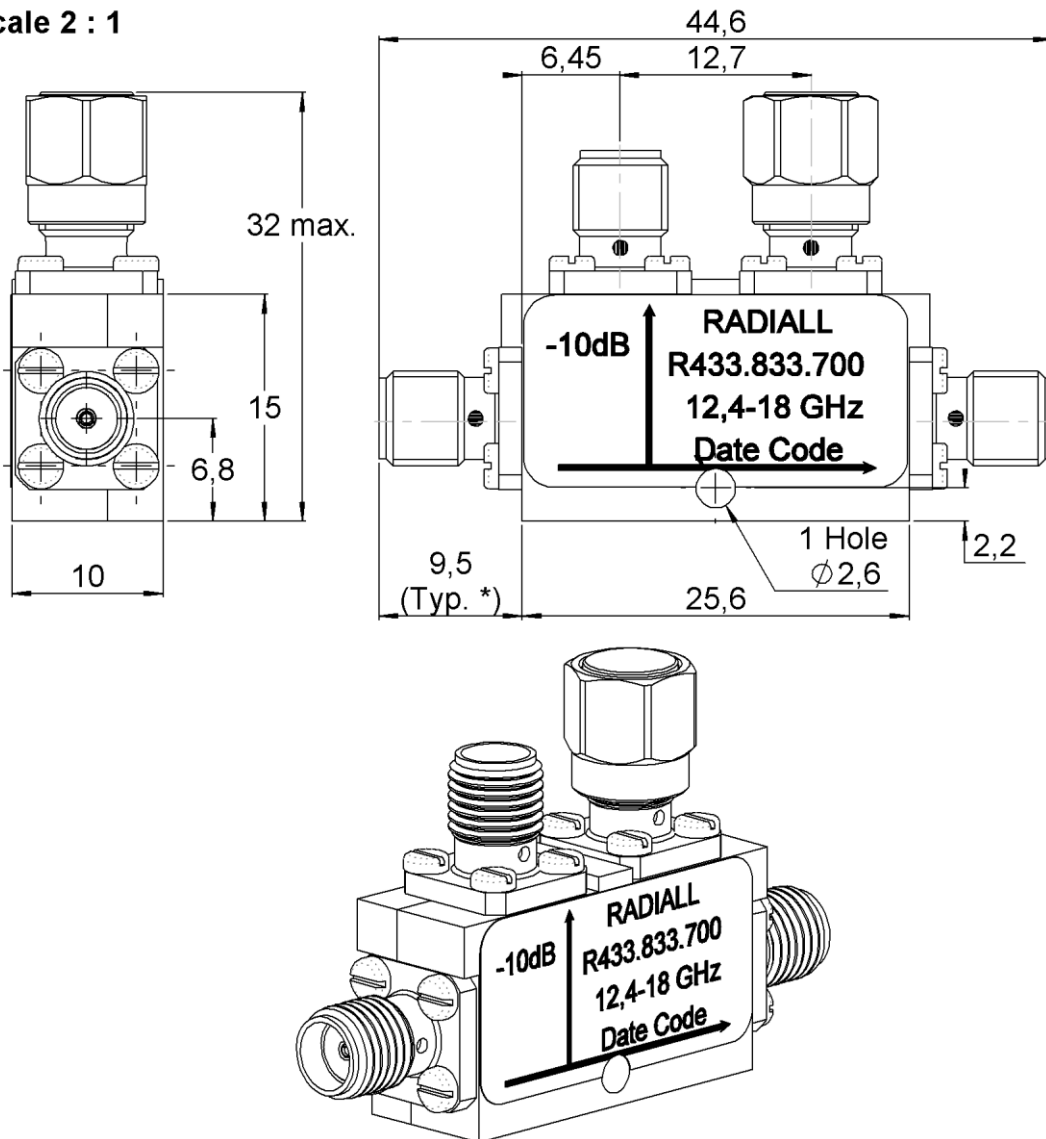

All dimensions are in mm. Tolerances according ISO 2768 m-H

Weight Specification **15,6800** g

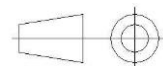

ELECTRICAL CHARACTERISTICS

Frequency operating range :	12.4 – 18 GHz
Impedance :	50 Ω
VSWR : - Main Line	1.35 max.
- Coupled Line	1.35 max.
Nominal Coupling :	10 dB
Coupling Precision :	± 1 dB
Directivity :	15 dB mini
Insertion loss :	1.1 dB max.
Frequency Sensitivity :	± 0.5 dB
Average Power at 25°C	50W
Peak Power at 25°C	3000W

MECHANICAL CHARACTERISTICS

Connector type :	SMA female per MIL-C 39012
Coaxial Termination :	SMA, 50 Ω , 1W

ENVIRONMENTAL CHARACTERISTICS

Operating temperature :	-40°C / +100°C
Storage temperature :	-40°C / +100°C