

**TIL189-1 THRU TIL189-4  
TIL190-1 THRU TIL190-4  
OPTOCOUPLED/OPTOISOLATORS**

SOOS038A D2987, JANUARY 1987—REVISED JULY 1989

- High Direct-Current Transfer Ratios, 500% Minimum at  $I_F = 10 \text{ mA}$  and Up to 1500% at  $I_F = 2 \text{ mA}$  with Choice of Four Categories
- Plastic Dual-In-Line Package
- High-Voltage Electrical Isolation, 3.535 kV Peak (2.5 kV rms)
- Gallium Arsenide Diode Infrared Source Optically Coupled to a Silicon N-P-N Darlington Phototransistor
- No Base Lead Connection on TIL190 for High-EMI Environment
- UL Recognized — File # E65085

**description**

The TIL189 and TIL190 Optocouplers are designed for use in applications that require high current transfer ratio and high voltage isolation between the input and output. The TIL189 has the base connected for applications where a base signal or resistor is required. The TIL190 is designed with no internal base connection for applications where high base-noise immunity is desired. Users can select from four different current gains (TIL189-1 through TIL189-4 and TIL190-1 through TIL190-4).

**mechanical data**

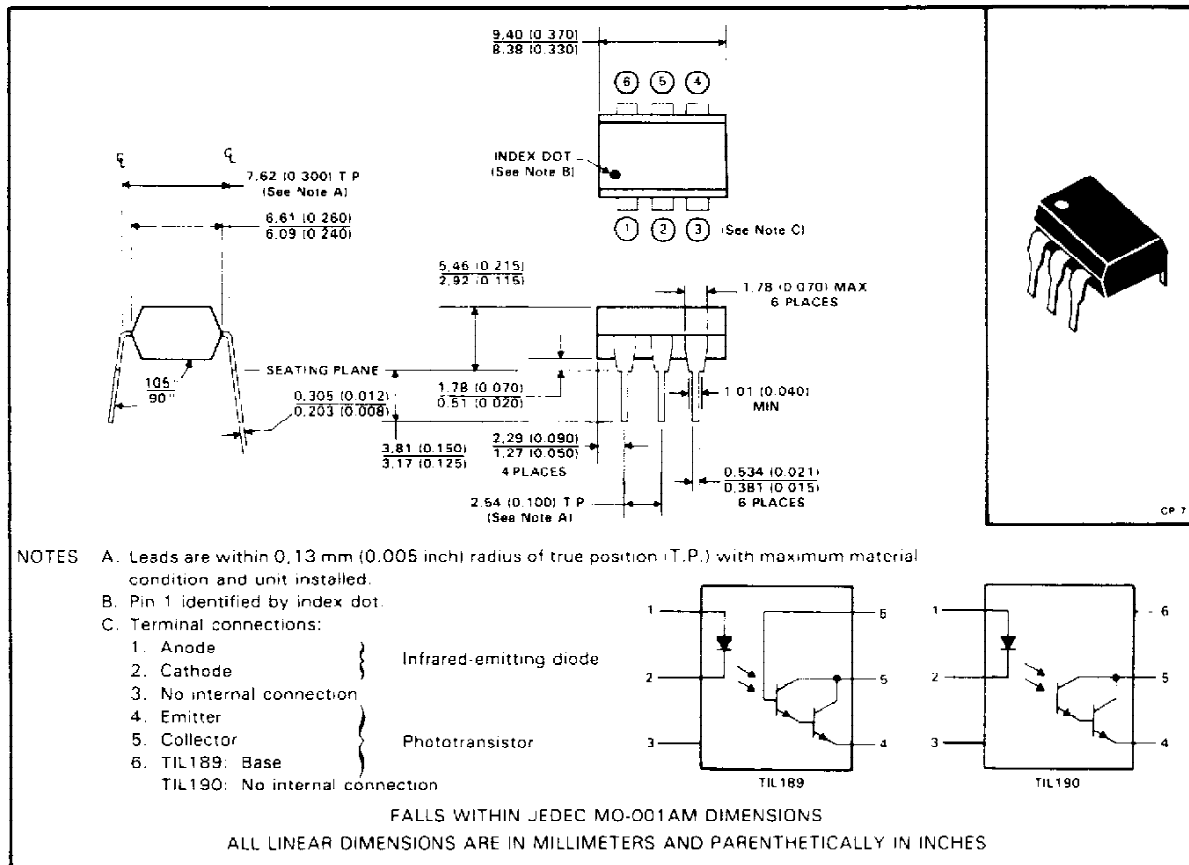

PRODUCTION DATA documents contain information current as of publication date. Products conform to specifications per the terms of Texas Instruments standard warranty. Production processing does not necessarily include testing of all parameters.

Copyright © 1989, Texas Instruments Incorporated

**TEXAS  
INSTRUMENTS**

POST OFFICE BOX 655303 • DALLAS, TEXAS 75265

**TIL189-1 THRU TIL189-4  
TIL190-1 THRU TIL190-4  
OPTOCOUPERS/OPTOISOLATORS**

---

**absolute maximum ratings at 25°C free-air temperature (unless otherwise noted)**

Input-to-output voltage	±3.535 kV peak or dc (±2.5 kV rms)
Collector-base voltage (TIL189)	100 V
Collector-emitter voltage (see Note 1)	55 V
Emitter-collector voltage	7 V
Emitter-base voltage (TIL189)	14 V
Input diode reverse voltage	3 V
Input diode continuous forward current at (or below)	
25°C free-air temperature (see Note 2)	100 mA
Continuous power dissipation at (or below) 25°C free-air temperature:	
Infrared-emitting diode (see Note 3)	150 mW
Phototransistor (see Note 3)	150 mW
Total, infrared-emitting diode plus phototransistor (see Note 4)	250 mW
Storage temperature range	-55°C to 150°C
Lead temperature 1,6 mm (1/16-inch) from case for 10 seconds	260°C

- NOTES: 1. This value applies when the base-emitter diode is open circuited.  
 2. Derate linearly to 100°C free-air temperature at the rate of 1.33 mA/°C.  
 3. Derate linearly to 100°C free-air temperature at the rate of 2 mW/°C.  
 4. Derate linearly to 100°C free-air temperature at the rate of 3.33 mW/°C.

**TIL189-1 THRU TIL189-4**  
**TIL190-1 THRU TIL190-4**  
**OPTOCOUPERS/OPTOISOLATORS**

electrical characteristics at 25°C free-air temperature (unless otherwise noted)

PARAMETER		TEST CONDITIONS	TIL189			TIL190			UNIT		
			MIN	TYP	MAX	MIN	TYP	MAX			
$V_{(BR)CBO}$	Collector-base breakdown voltage	$I_C = 10 \mu A, I_E = 0, I_F = 0$	100						V		
$V_{(BR)CEO}$	Collector-emitter breakdown voltage	$I_C = 1 mA, I_B = 0, I_F = 0$	55			65			V		
$V_{(BR)EBO}$	Emitter-base breakdown voltage	$I_E = 10 \mu A, I_C = 0, I_F = 0$	14						V		
$V_{(BR)ECO}$	Emitter-collector breakdown voltage	$I_E = 100 \mu A, I_F = 0$				7			V		
$I_R$	Input diode static reverse current	$V_R = 3 V$				10			$\mu A$		
$I_{C(on)}$	On-state collector current	Photo-transistor operation $V_{CE} = 1 V, I_F = 2 mA, I_B = 0$	TIL189-1, TIL190-1			5			mA		
			TIL189-2, TIL190-2			10					
			TIL189-3, TIL190-3			20					
			TIL189-4, TIL190-4			30					
		$V_{CE} = 1 V, I_F = 10 mA, I_B = 0$	50			50					
	Photodiode operation	$V_{CB} = 1 V, I_F = 10 mA, I_E = 0$	5	15				$\mu A$			
$I_{C(off)}$	Off-state collector current	$V_{CE} = 10 V, I_F = 0, I_B = 0$	1			100			nA		
$h_{FE}$	Transistor static forward current transfer ratio	$V_{CE} = 1 V, I_C = 10 mA, I_F = 0$	25000								
$V_F$	Input diode static forward voltage	$I_F = 10 mA$	1.2		1.5		1.2		1.5		V
$V_{CE(sat)}$	Collector-emitter saturation voltage	$I_C = 50 mA, I_F = 10 mA, I_B = 0$	0.87		1		0.87		1		V
$r_{iD}$	Input-to-output internal resistance	$V_{in-out} = \pm 500 V, \text{ See Note 5}$	$10^{11}$			$10^{11}$			$\Omega$		
$C_{io}$	Input-to-output capacitance	$V_{in-out} = 0, f = 1 MHz, \text{ See Note 5}$	1		1.3		1		1.3		pF

NOTE 5: These parameters are measured between both input-diode leads shorted together and all the phototransistor leads shorted together.

switching characteristics at 25°C free-air temperature

PARAMETER	TEST CONDITIONS	TIL189			TIL190			UNIT
		MIN	TYP	MAX	MIN	TYP	MAX	
$t_r$ Rise time	$V_{CC} = 10 V, I_{C(on)} = 10 mA,$	100			100			$\mu s$
$t_f$ Fall time	$R_L = 100 \Omega, \text{ see Figure 1}$	100			100			$\mu s$

**TIL189-1 THRU TIL189-4  
TIL190-1 THRU TIL190-4  
OPTOCOUPLED/OPTOISOLATORS**

**PARAMETER MEASUREMENT INFORMATION**

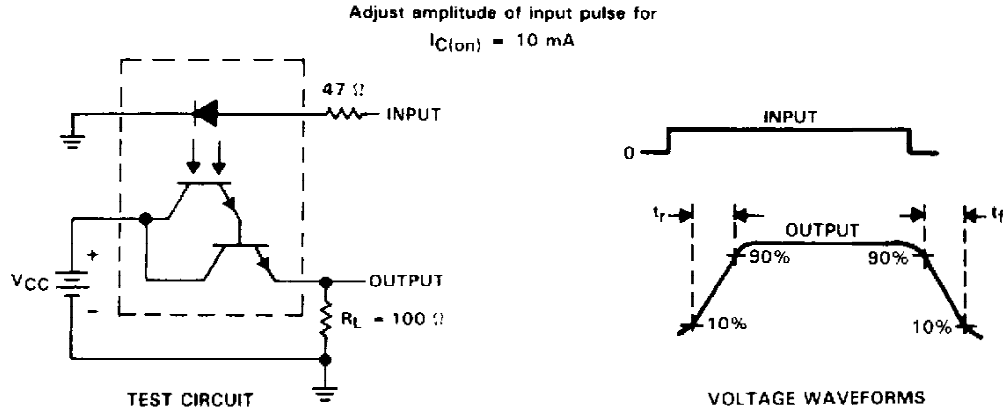

NOTES: A The input waveform is supplied by a generator with the following characteristics:  $Z_0 = 50 \Omega$ ,  $t_r \leq 15 \text{ ns}$ , duty cycle = 1%.  
B The output waveform is monitored on an oscilloscope with the following characteristics:  $t_f \leq 12 \text{ ns}$ ,  $R_1 \geq 1 \text{ M}\Omega$ ,  $C_{IN} \leq 20 \text{ pF}$ .

**FIGURE 1. SWITCHING TIMES**

**TYPICAL CHARACTERISTICS**

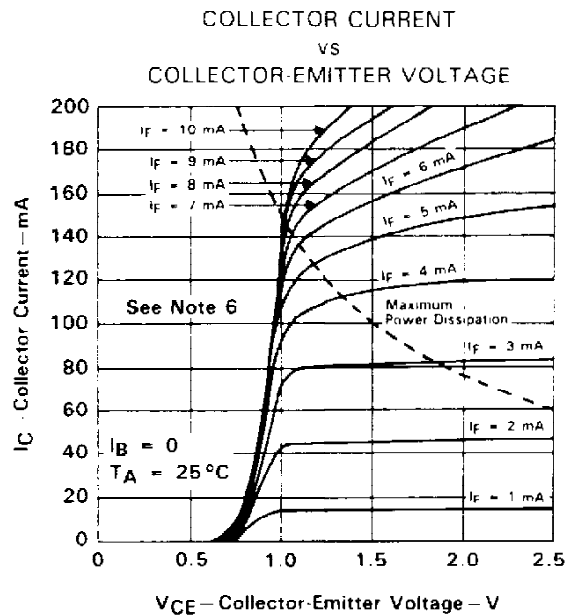
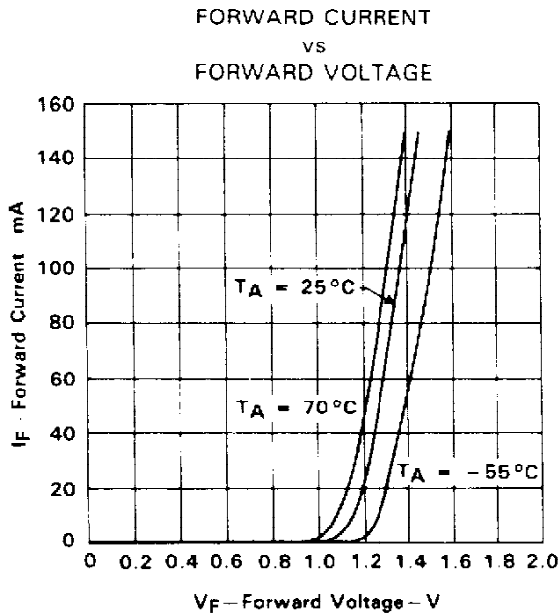

NOTE 6 Pulse operation is required for operation beyond limits shown by the dashed line.

TYPICAL CHARACTERISTICS

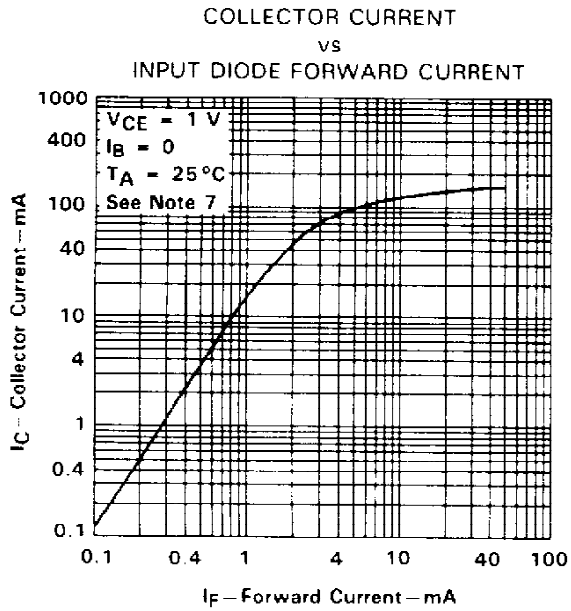

FIGURE 4

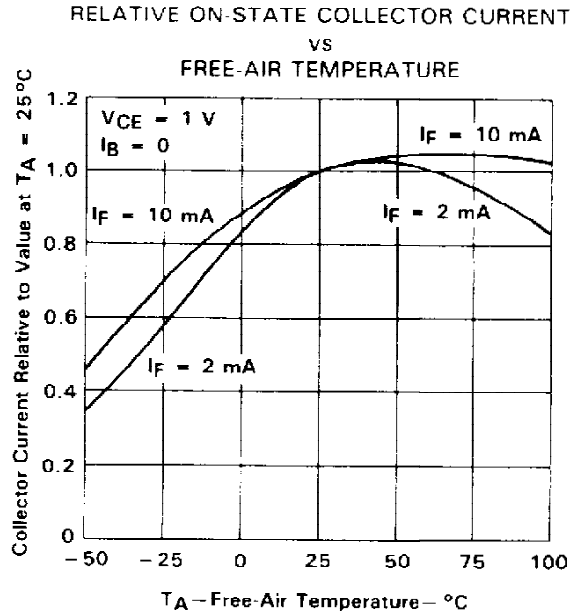

FIGURE 5

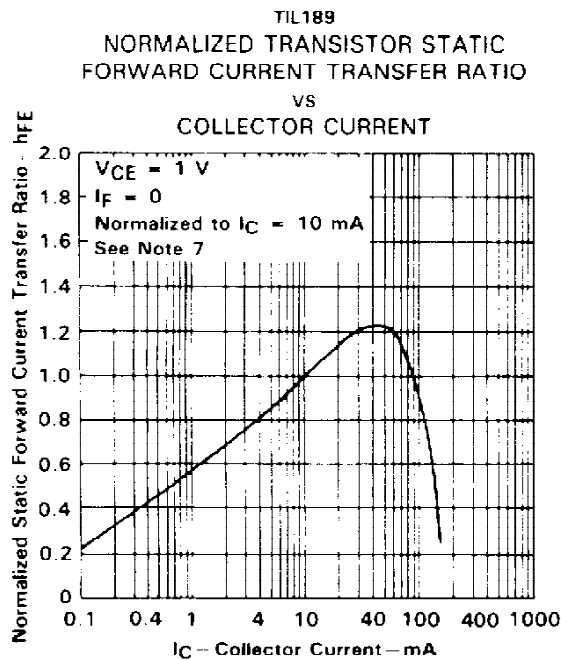

FIGURE 6

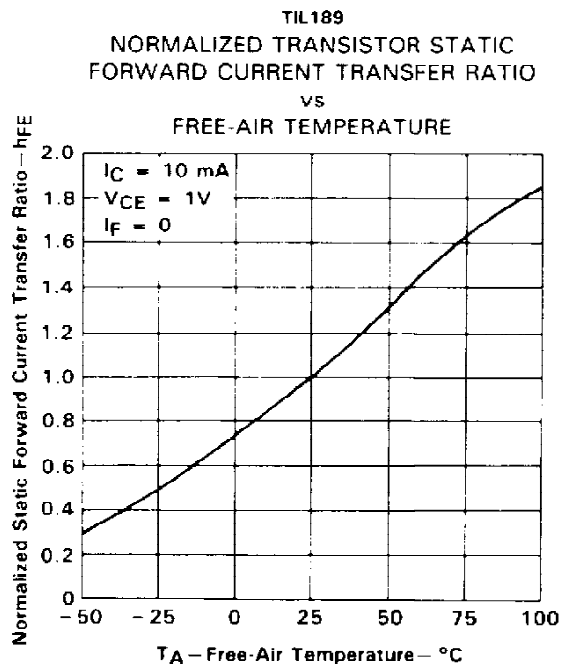
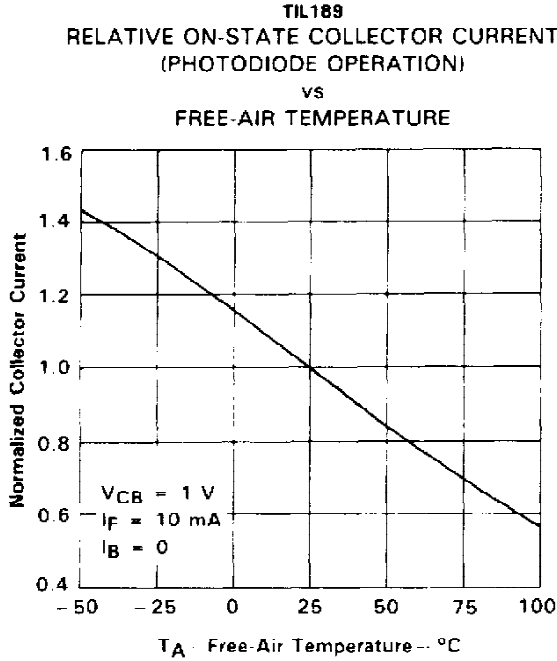

FIGURE 7

NOTE 7: These parameters were measured using pulse techniques  $t_w = 1\text{ ms}$ , duty cycle  $\leq 2\%$ .

**TIL189-1 THRU TIL189-4**  
**TIL190-1 THRU TIL190-4**  
**OPTOCOUPERS/OPTOISOLATORS**

**TYPICAL CHARACTERISTICS**



**FIGURE 8**

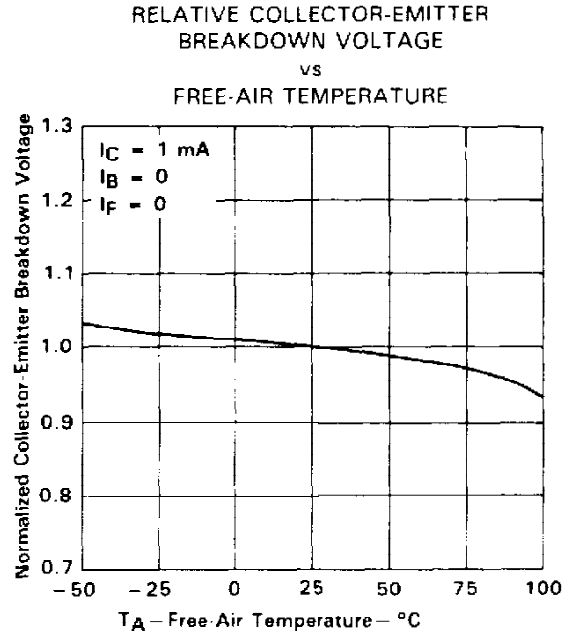

**FIGURE 9**

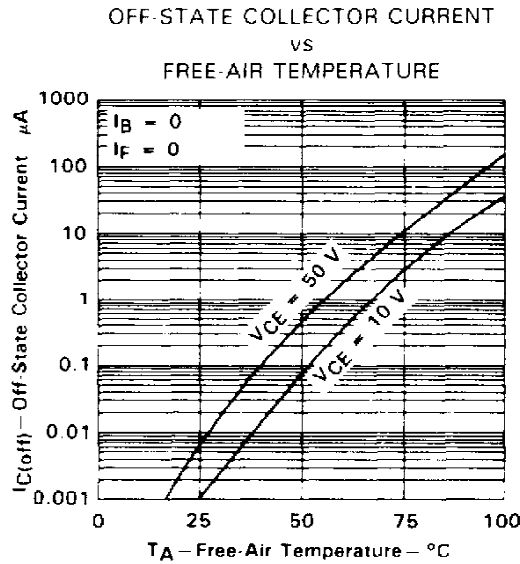

**FIGURE 10**

## IMPORTANT NOTICE

Texas Instruments (TI) reserves the right to make changes to its products or to discontinue any semiconductor product or service without notice, and advises its customers to obtain the latest version of relevant information to verify, before placing orders, that the information being relied on is current.

TI warrants performance of its semiconductor products and related software to the specifications applicable at the time of sale in accordance with TI's standard warranty. Testing and other quality control techniques are utilized to the extent TI deems necessary to support this warranty. Specific testing of all parameters of each device is not necessarily performed, except those mandated by government requirements.

Certain applications using semiconductor products may involve potential risks of death, personal injury, or severe property or environmental damage ("Critical Applications").

TI SEMICONDUCTOR PRODUCTS ARE NOT DESIGNED, INTENDED, AUTHORIZED, OR WARRANTED TO BE SUITABLE FOR USE IN LIFE-SUPPORT APPLICATIONS, DEVICES OR SYSTEMS OR OTHER CRITICAL APPLICATIONS.

Inclusion of TI products in such applications is understood to be fully at the risk of the customer. Use of TI products in such applications requires the written approval of an appropriate TI officer. Questions concerning potential risk applications should be directed to TI through a local SC sales office.

In order to minimize risks associated with the customer's applications, adequate design and operating safeguards should be provided by the customer to minimize inherent or procedural hazards.

TI assumes no liability for applications assistance, customer product design, software performance, or infringement of patents or services described herein. Nor does TI warrant or represent that any license, either express or implied, is granted under any patent right, copyright, mask work right, or other intellectual property right of TI covering or relating to any combination, machine, or process in which such semiconductor products or services might be or are used.

**PACKAGING INFORMATION**

Orderable Device	Status <sup>(1)</sup>	Package Type	Package Drawing	Pins	Package Qty	Eco Plan <sup>(2)</sup>	Lead/Ball Finish	MSL Peak Temp <sup>(3)</sup>
TIL189-1	OBSOLETE	PDIP	N	6		TBD	Call TI	Call TI
TIL189-3	OBSOLETE	PDIP	N	6		TBD	Call TI	Call TI
TIL189-4	OBSOLETE	PDIP	N	6		TBD	Call TI	Call TI
TIL190-1	OBSOLETE	PDIP	N	6		TBD	Call TI	Call TI
TIL190-2	OBSOLETE	PDIP	N	6		TBD	Call TI	Call TI
TIL190-3	OBSOLETE	PDIP	N	6		TBD	Call TI	Call TI
TIL190-4	OBSOLETE	PDIP	N	6		TBD	Call TI	Call TI

<sup>(1)</sup> The marketing status values are defined as follows:

**ACTIVE:** Product device recommended for new designs.

**LIFEBUY:** TI has announced that the device will be discontinued, and a lifetime-buy period is in effect.

**NRND:** Not recommended for new designs. Device is in production to support existing customers, but TI does not recommend using this part in a new design.

**PREVIEW:** Device has been announced but is not in production. Samples may or may not be available.

**OBSOLETE:** TI has discontinued the production of the device.

<sup>(2)</sup> Eco Plan - The planned eco-friendly classification: Pb-Free (RoHS) or Green (RoHS & no Sb/Br) - please check <http://www.ti.com/productcontent> for the latest availability information and additional product content details.

**TBD:** The Pb-Free/Green conversion plan has not been defined.

**Pb-Free (RoHS):** TI's terms "Lead-Free" or "Pb-Free" mean semiconductor products that are compatible with the current RoHS requirements for all 6 substances, including the requirement that lead not exceed 0.1% by weight in homogeneous materials. Where designed to be soldered at high temperatures, TI Pb-Free products are suitable for use in specified lead-free processes.

**Green (RoHS & no Sb/Br):** TI defines "Green" to mean Pb-Free (RoHS compatible), and free of Bromine (Br) and Antimony (Sb) based flame retardants (Br or Sb do not exceed 0.1% by weight in homogeneous material)

<sup>(3)</sup> MSL, Peak Temp. -- The Moisture Sensitivity Level rating according to the JEDEC industry standard classifications, and peak solder temperature.

**Important Information and Disclaimer:**The information provided on this page represents TI's knowledge and belief as of the date that it is provided. TI bases its knowledge and belief on information provided by third parties, and makes no representation or warranty as to the accuracy of such information. Efforts are underway to better integrate information from third parties. TI has taken and continues to take reasonable steps to provide representative and accurate information but may not have conducted destructive testing or chemical analysis on incoming materials and chemicals. TI and TI suppliers consider certain information to be proprietary, and thus CAS numbers and other limited information may not be available for release.

In no event shall TI's liability arising out of such information exceed the total purchase price of the TI part(s) at issue in this document sold by TI to Customer on an annual basis.



## IMPORTANT NOTICE

Texas Instruments Incorporated and its subsidiaries (TI) reserve the right to make corrections, modifications, enhancements, improvements, and other changes to its products and services at any time and to discontinue any product or service without notice. Customers should obtain the latest relevant information before placing orders and should verify that such information is current and complete. All products are sold subject to TI's terms and conditions of sale supplied at the time of order acknowledgment.

TI warrants performance of its hardware products to the specifications applicable at the time of sale in accordance with TI's standard warranty. Testing and other quality control techniques are used to the extent TI deems necessary to support this warranty. Except where mandated by government requirements, testing of all parameters of each product is not necessarily performed.

TI assumes no liability for applications assistance or customer product design. Customers are responsible for their products and applications using TI components. To minimize the risks associated with customer products and applications, customers should provide adequate design and operating safeguards.

TI does not warrant or represent that any license, either express or implied, is granted under any TI patent right, copyright, mask work right, or other TI intellectual property right relating to any combination, machine, or process in which TI products or services are used. Information published by TI regarding third-party products or services does not constitute a license from TI to use such products or services or a warranty or endorsement thereof. Use of such information may require a license from a third party under the patents or other intellectual property of the third party, or a license from TI under the patents or other intellectual property of TI.

Reproduction of information in TI data books or data sheets is permissible only if reproduction is without alteration and is accompanied by all associated warranties, conditions, limitations, and notices. Reproduction of this information with alteration is an unfair and deceptive business practice. TI is not responsible or liable for such altered documentation.

Resale of TI products or services with statements different from or beyond the parameters stated by TI for that product or service voids all express and any implied warranties for the associated TI product or service and is an unfair and deceptive business practice. TI is not responsible or liable for any such statements.

Following are URLs where you can obtain information on other Texas Instruments products and application solutions:

<b>Products</b>		<b>Applications</b>	
Amplifiers	<a href="http://amplifier.ti.com">amplifier.ti.com</a>	Audio	<a href="http://www.ti.com/audio">www.ti.com/audio</a>
Data Converters	<a href="http://dataconverter.ti.com">dataconverter.ti.com</a>	Automotive	<a href="http://www.ti.com/automotive">www.ti.com/automotive</a>
DSP	<a href="http://dsp.ti.com">dsp.ti.com</a>	Broadband	<a href="http://www.ti.com/broadband">www.ti.com/broadband</a>
Interface	<a href="http://interface.ti.com">interface.ti.com</a>	Digital Control	<a href="http://www.ti.com/digitalcontrol">www.ti.com/digitalcontrol</a>
Logic	<a href="http://logic.ti.com">logic.ti.com</a>	Military	<a href="http://www.ti.com/military">www.ti.com/military</a>
Power Mgmt	<a href="http://power.ti.com">power.ti.com</a>	Optical Networking	<a href="http://www.ti.com/opticalnetwork">www.ti.com/opticalnetwork</a>
Microcontrollers	<a href="http://microcontroller.ti.com">microcontroller.ti.com</a>	Security	<a href="http://www.ti.com/security">www.ti.com/security</a>
		Telephony	<a href="http://www.ti.com/telephony">www.ti.com/telephony</a>
		Video & Imaging	<a href="http://www.ti.com/video">www.ti.com/video</a>
		Wireless	<a href="http://www.ti.com/wireless">www.ti.com/wireless</a>

Mailing Address: Texas Instruments  
Post Office Box 655303 Dallas, Texas 75265