

FMM7G50US60N

Compact & Complex Module

General Description

Fairchild IGBT Power Module provides low conduction and switching losses as well as short circuit ruggedness. It's designed for the applications such as motor control and general inverters where short-circuit ruggedness is required.

Features

- Short Circuit rated Time 10us @ $T_C = 100^\circ\text{C}$, $V_{GE} = 15\text{V}$
- High Speed Switching
- Low Saturation Voltage : $V_{CE(sat)} = 2.1\text{V}$ @ $I_C = 50\text{A}$
- High Input Impedance
- Built-in Brake & 3 Phase Rectifier Circuit
- Fast & Soft Anti-Parallel FWD
- Built-in NTC Thermistor
- UL Certified No. E209204

Application

- AC & DC Motor Controls
- General Purpose Inverters
- Robotics
- Servo Controls

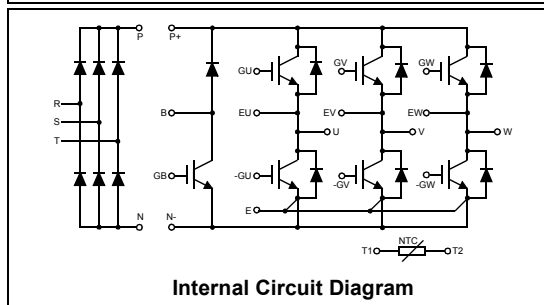
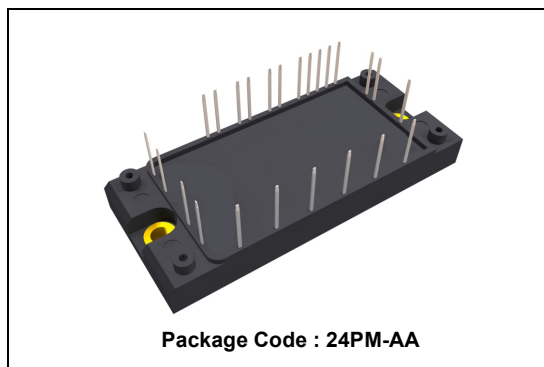

Absolute Maximum Ratings $T_C = 25^\circ\text{C}$ unless otherwise noted

	Symbol	Description	FMM7G50US60N	Units
Inverter & Brake	V_{CES}	Collector-Emitter Voltage	600	V
	V_{GES}	Gate-Emitter Voltage	± 20	V
	I_C	Collector Current @ $T_C = 80^\circ\text{C}$	50	A
	$I_{CM(1)}$	Pulsed Collector Current	100	A
	I_F	Diode Continuous Forward Current @ $T_C = 80^\circ\text{C}$	50	A
	I_{FM}	Diode Maximum Forward Current	100	A
	P_D	Maximum Power Dissipation @ $T_C = 25^\circ\text{C}$	139	W
Converter	T_{SC}	Short Circuit Withstand Time @ $T_C = 100^\circ\text{C}$	10	us
	V_{RRM}	Repetitive Peak Reverse Voltage	1600	V
	I_O	Average Output Rectified Current	50	A
	I_{FSM}	Surge Forward Current @ 1Cycle at 60Hz, Peak value Non-Repetitive	320	A
Common	i^2t	Energy pulse @ 1Cycle at 60Hz	419	A^2s
	T_J	Operating Junction Temperature	-40 to +150	$^\circ\text{C}$
	T_{STG}	Storage Temperature Range	-40 to +125	$^\circ\text{C}$
	V_{ISO}	Isolation Voltage @ AC 1minute	2500	V
Mounting Torque		Mounting part Screw @ M4	4.0	N.m

Notes :

(1) Repetitive rating : Pulse width limited by max. junction temperature

Electrical Characteristics of IGBT @ Inverter & Brake $T_C = 25^\circ\text{C}$ unless otherwise noted

Symbol	Parameter	Test Conditions	Min.	Typ.	Max.	Units
Off Characteristics						
BV_{CES}	Collector-Emitter Breakdown Voltage	$V_{GE} = 0V, I_C = 250\mu A$	600	--	--	V
$\Delta BV_{CES}/\Delta T_J$	Temperature Coeff. of Breakdown Voltage	$V_{GE} = 0V, I_C = 1mA$	--	0.6	--	$V/^\circ C$
I_{CES}	Collector Cut-Off Current	$V_{CE} = V_{CES}, V_{GE} = 0V$	--	--	250	μA
I_{GES}	Gate - Emitter Leakage Current	$V_{GE} = V_{GES}, V_{CE} = 0V$	--	--	± 100	nA

On Characteristics

$V_{GE(th)}$	Gate - Emitter Threshold Voltage	$I_C = 50mA, V_{CE} = V_{GE}$	5.0	6.5	8.5	V
$V_{CE(sat)}$	Collector to Emitter Saturation Voltage	$I_C = 50A, V_{GE} = 15V$	--	2.1	2.7	V

Dynamic Characteristics

C_{ies}	Input Capacitance	$V_{CE} = 30V, V_{GE} = 0V,$ $f = 1MHz$	--	3565	--	pF
C_{oes}	Output Capacitance		--	286	--	pF
C_{res}	Reverse Transfer Capacitance		--	60	--	pF

Switching Characteristics

$t_{d(on)}$	Turn-On Delay Time	$V_{CC} = 300V, I_C = 50A,$ $R_G = 10\Omega, V_{GE} = 15V,$ Inductive Load, $T_C = 25^\circ C$	--	90	200	ns
t_r	Rise Time		--	60	150	ns
$t_{d(off)}$	Turn-Off Delay Time		--	110	200	ns
t_f	Fall Time		--	120	250	ns
E_{on}	Turn-On Switching Loss		--	1.08	--	mJ
E_{off}	Turn-Off Switching Loss		--	0.95	--	mJ
$t_{d(on)}$	Turn-On Delay Time	$V_{CC} = 300V, I_C = 50A,$ $R_G = 10\Omega, V_{GE} = 15V,$ Inductive Load, $T_C = 125^\circ C$	--	80	200	ns
t_r	Rise Time		--	60	150	ns
$t_{d(off)}$	Turn-Off Delay Time		--	110	200	ns
t_f	Fall Time		--	210	400	ns
E_{on}	Turn-On Switching Loss		--	1.28	--	mJ
E_{off}	Turn-Off Switching Loss		--	1.5	--	mJ
T_{sc}	Short Circuit Withstand Time	$V_{CC} = 300V, V_{GE} = 15V$ @ $T_C = 100^\circ C$	10	--	--	us
Q_g	Total Gate Charge	$V_{CE} = 300V, I_C = 50A,$ $V_{GE} = 15V$	--	150	300	nC
Q_{ge}	Gate-Emitter Charge		--	35	70	nC
Q_{gc}	Gate-Collector Charge		--	60	120	nC

Electrical Characteristics of DIODE @ Inverter & Brake $T_C = 25^\circ\text{C}$ unless otherwise noted

Symbol	Parameter	Test Conditions	Min.	Typ.	Max.	Units	
V_{FM}	Diode Forward Voltage	$I_F = 50\text{A}$	$T_C = 25^\circ\text{C}$	--	1.9	2.8	V
			$T_C = 100^\circ\text{C}$	--	2.0	--	
t_{rr}	Diode Reverse Recovery Time		$T_C = 25^\circ\text{C}$	--	75	150	ns
			$T_C = 100^\circ\text{C}$	--	130	--	
I_{rr}	Diode Peak Reverse Recovery Current	$I_F = 50\text{A}$ $di / dt = 100 \text{ A/us}$	$T_C = 25^\circ\text{C}$	--	5	6.5	A
			$T_C = 100^\circ\text{C}$	--	7	--	
Q_{rr}	Diode Reverse Recovery Charge		$T_C = 25^\circ\text{C}$	--	225	422	nC
			$T_C = 100^\circ\text{C}$	--	455	--	

Electrical Characteristics of DIODE @ Converter $T_C = 25^\circ\text{C}$ unless otherwise noted

Symbol	Parameter	Test Conditions	Min.	Typ.	Max.	Units	
V_{FM}	Diode Forward Voltage	$I_F = 50\text{A}$	$T_C = 25^\circ\text{C}$	--	1.2	1.6	V
			$T_C = 100^\circ\text{C}$	--	1.2	--	
I_{RRM}	Repetitive Reverse Current	$V_R = V_{RRM}$	$T_C = 25^\circ\text{C}$	--	--	8	mA
			$T_C = 100^\circ\text{C}$	--	5	--	

Thermal Characteristics

	Symbol	Parameter	Typ.	Max.	Units
Inverter	$R_{\theta JC}$	Junction-to-Case (IGBT Part, per 1/6 Module)	--	0.9	$^\circ\text{C/W}$
	$R_{\theta JC}$	Junction-to-Case (DIODE Part, per 1/6 Module)	--	1.3	$^\circ\text{C/W}$
Brake	$R_{\theta JC}$	Junction-to-Case (IGBT Part, per 1/6 Module)	--	0.9	$^\circ\text{C/W}$
	$R_{\theta JC}$	Junction-to-Case (DIODE Part, per 1/6 Module)	--	1.3	$^\circ\text{C/W}$
Converter	$R_{\theta JC}$	Junction-to-Case (DIODE Part, per 1/6 Module)	--	1.3	$^\circ\text{C/W}$
Weight		Weight of Module	210	--	g

NTC Thermistor Characteristics

	Symbol	Parameter	Tol.	Typ.	Units
Thermistor	R_{25}	Rated Resistance @ $T_C = 25^\circ\text{C}$	+/- 5 %	5	$\text{K}\Omega$
	R_{100}	Rated Resistance @ $T_C = 100^\circ\text{C}$	+/- 5 %	0.415	$\text{K}\Omega$
	$B_{(25/100)}$	B - Value	+/- 3 %	3692	

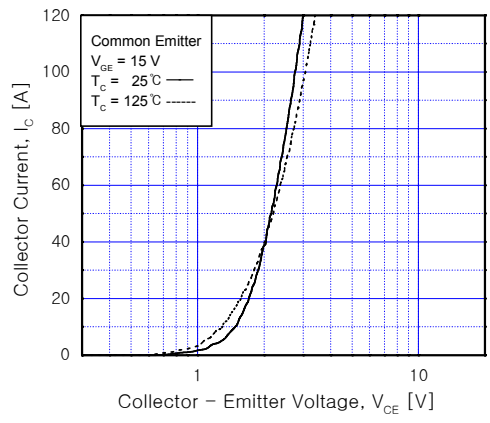

Fig 1. Typical Output Characteristics

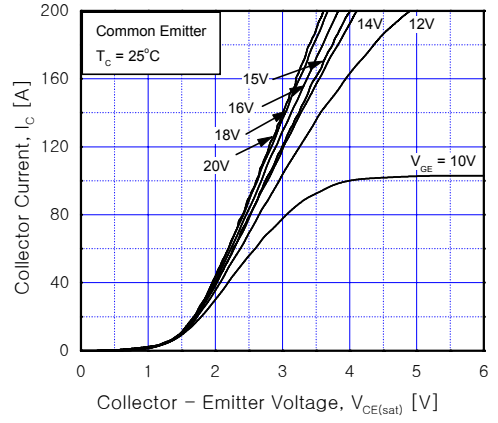

Fig 2. Typical Saturation Voltage Characteristics

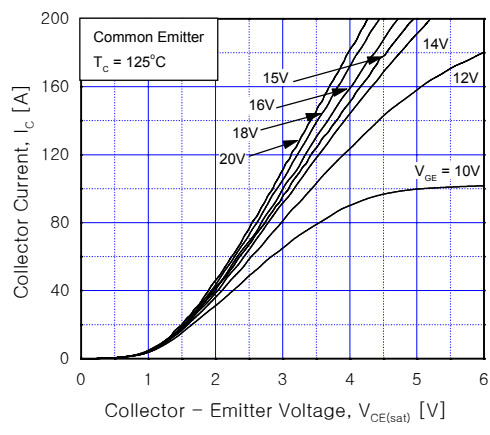

Fig 3. Typical Saturation Voltage Characteristics

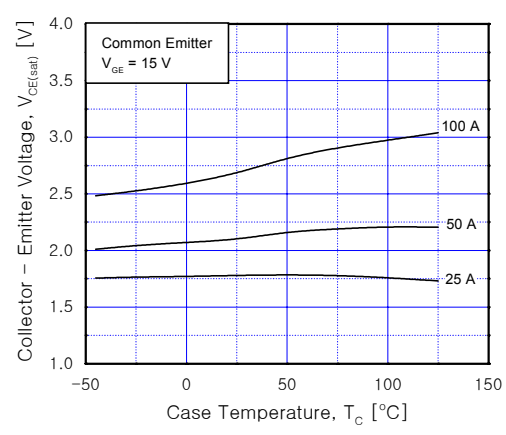

Fig 4. Saturation Voltage vs. Case Temperature at Variant Current Level

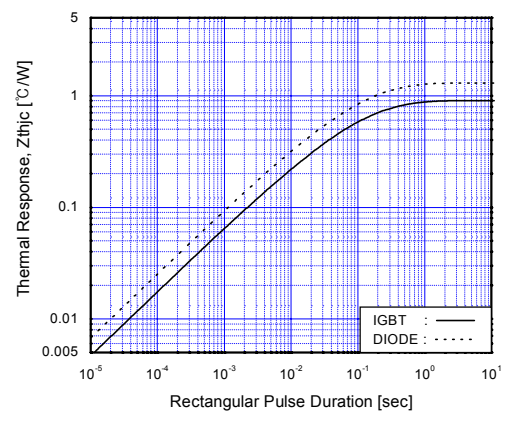

Fig 5. Transient Thermal Impedance

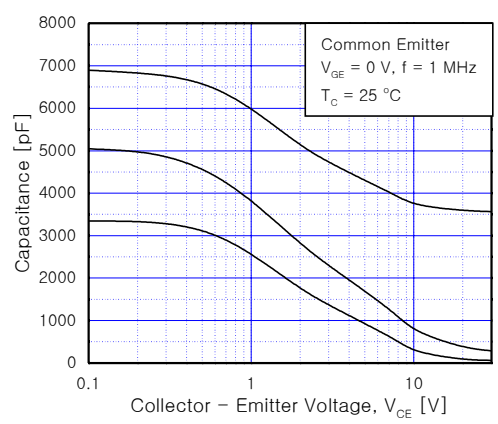

Fig 6. Capacitance Characteristics

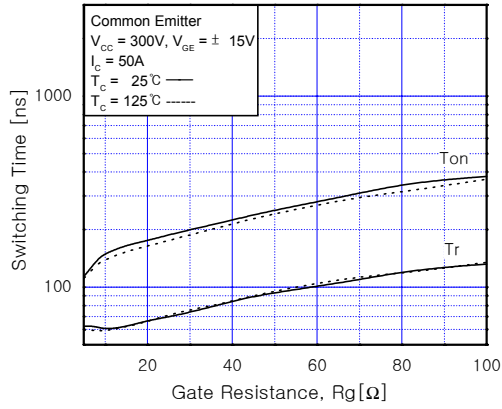

Fig 7. Turn-On Characteristics vs. Gate Resistance

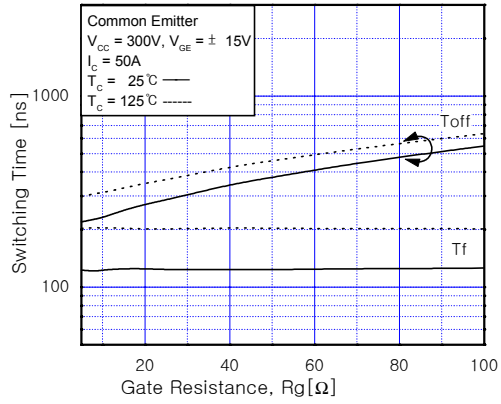

Fig 8. Turn-Off Characteristics vs. Gate Resistance

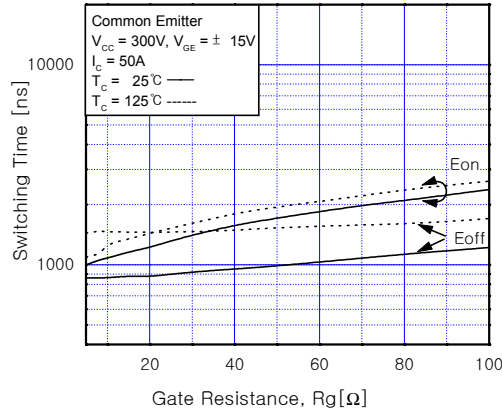

Fig 9. Switching Loss vs. Gate Resistance

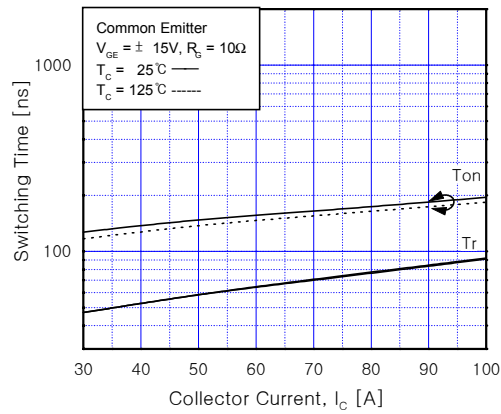

Fig 10. Turn-On Characteristics vs. Collector Current

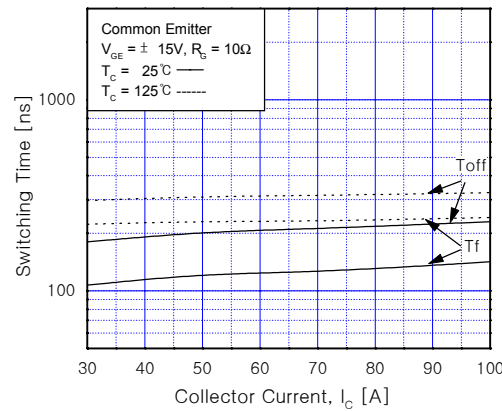

Fig 11. Turn-Off Characteristics vs. Collector Current

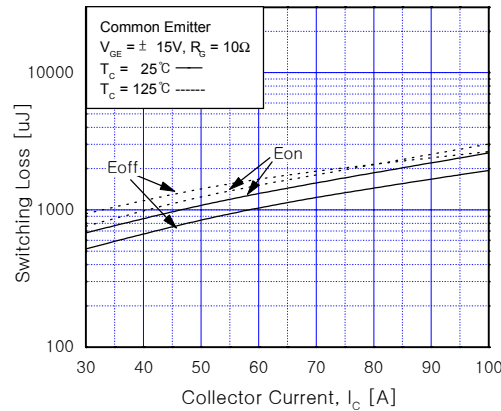

Fig 12. Switching Loss vs. Collector Current

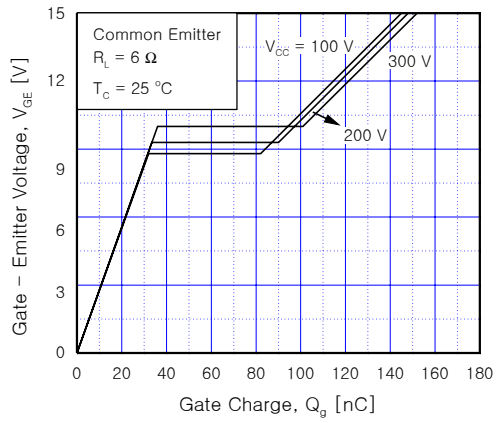

Fig 13. Gate Charge Characteristics

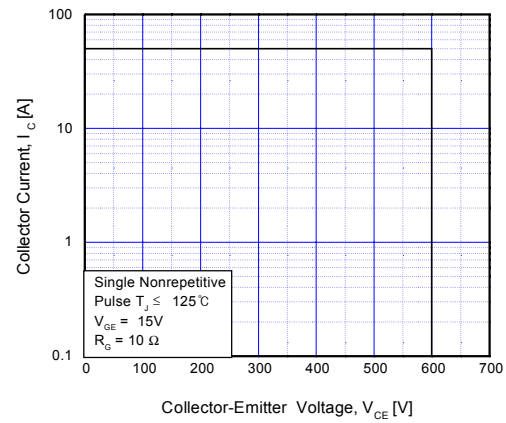

Fig 14. RBSOA Characteristics

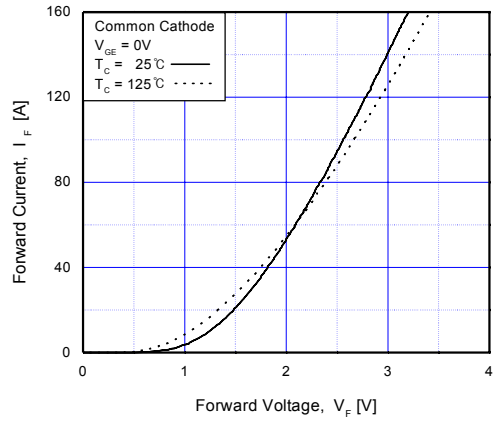

Fig 15. Forward Characteristics

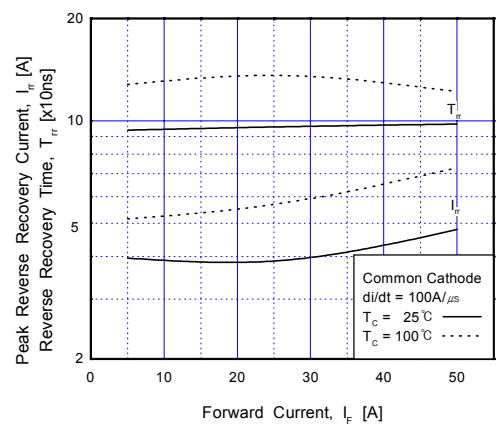

Fig 16. Reverse Recovery Characteristics

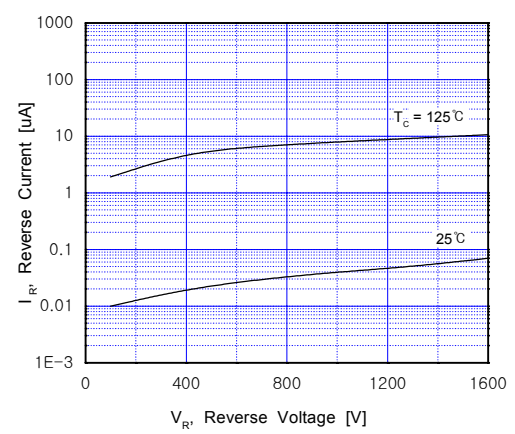

Fig 17. Rectifier (Converter) Characteristics

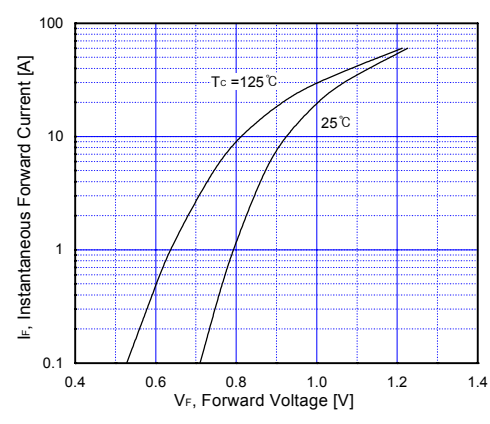

Fig 18. Rectifier (Converter) Characteristics

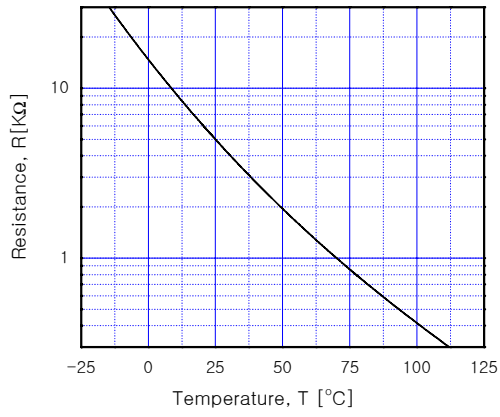

Fig 19. NTC Characteristics

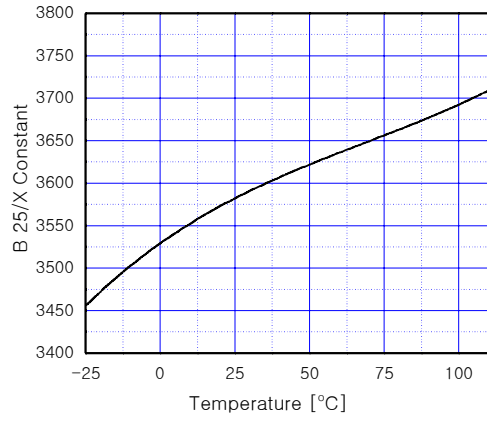
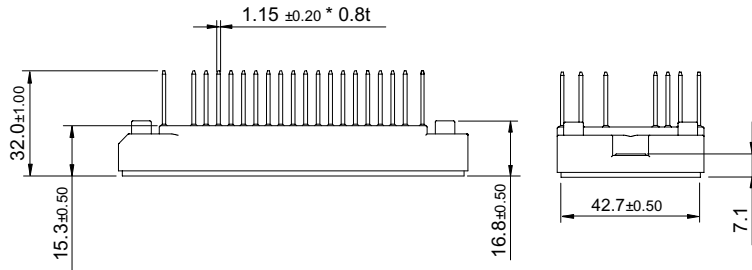
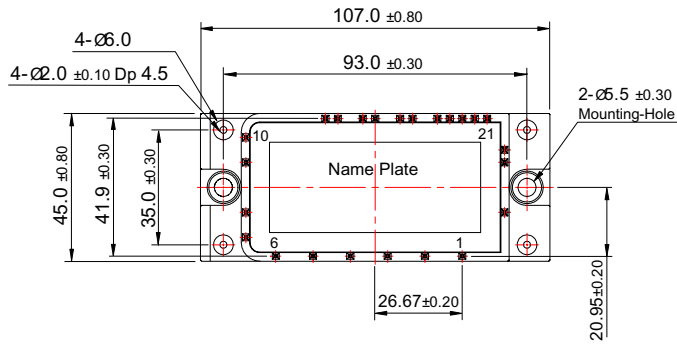

Fig 20. NTC Characteristics

Package Dimension

24PM-AA



-. Pin Coordinate

Pin #No	Coordinate	
	x	y
1	0.0	0.0
2	-11.43	0.0
3	-22.86	0.0
4	-34.29	0.0
5	-45.72	0.0
6	-57.15	0.0
7	-66.27	5.71
8	-66.27	13.33
9	-66.27	28.57
10	-66.27	36.19
11	-41.91	41.90
12	-38.10	41.90
13	-30.48	41.90
14	-26.67	41.90
15	-19.05	41.90
16	-15.24	41.90
17	-7.62	41.90
18	-3.81	41.90
19	0.0	41.90
20	3.81	41.90
21	7.62	41.90
22	12.93	32.38
23	12.93	28.57
24	12.93	13.33

- datum pin : #1
- Pin Tilt : ±0.20

Dimensions in Millimeters

TRADEMARKS

The following are registered and unregistered trademarks Fairchild Semiconductor owns or is authorized to use and is not intended to be an exhaustive list of all such trademarks.

ACE ^x [™]	FACT [™]	ImpliedDisconnect [™]	PACMAN [™]	SPM [™]
ActiveArray [™]	FACT Quiet series [™]	ISOPLANAR [™]	POP [™]	Stealth [™]
Bottomless [™]	FAST [®]	LittleFET [™]	Power247 [™]	SuperSOT [™] -3
CoolFET [™]	FAST ^r [™]	MicroFET [™]	PowerTrench [®]	SuperSOT [™] -6
CROSSVOLT [™]	FRFET [™]	MicroPak [™]	QFET [™]	SuperSOT [™] -8
DOME [™]	GlobalOptoisolator [™]	MICROWIRE [™]	QS [™]	SyncFET [™]
EcoSPARK [™]	GTO [™]	MSX [™]	QT Optoelectronics [™]	TinyLogic [®]
E ² CMOS [™]	HiSeC [™]	MSXPro [™]	Quiet Series [™]	TruTranslation [™]
EnSigna [™]	I ² C [™]	OCX [™]	RapidConfigure [™]	UHC [™]
Across the board. Around the world. [™]		OCXPro [™]	RapidConnect [™]	UltraFET [®]
The Power Franchise [™]		OPTOLOGIC [®]	SILENT SWITCHER [®]	VCX [™]
Programmable Active Droop [™]		OPTOPLANAR [™]	SMART START [™]	

DISCLAIMER

FAIRCHILD SEMICONDUCTOR RESERVES THE RIGHT TO MAKE CHANGES WITHOUT FURTHER NOTICE TO ANY PRODUCTS HEREIN TO IMPROVE RELIABILITY, FUNCTION OR DESIGN. FAIRCHILD DOES NOT ASSUME ANY LIABILITY ARISING OUT OF THE APPLICATION OR USE OF ANY PRODUCT OR CIRCUIT DESCRIBED HEREIN; NEITHER DOES IT CONVEY ANY LICENSE UNDER ITS PATENT RIGHTS, NOR THE RIGHTS OF OTHERS.

LIFE SUPPORT POLICY

FAIRCHILD'S PRODUCTS ARE NOT AUTHORIZED FOR USE AS CRITICAL COMPONENTS IN LIFE SUPPORT DEVICES OR SYSTEMS WITHOUT THE EXPRESS WRITTEN APPROVAL OF FAIRCHILD SEMICONDUCTOR INTERNATIONAL.

As used herein:

1. Life support devices or systems are devices or systems which, (a) are intended for surgical implant into the body, or (b) support or sustain life, or (c) whose failure to perform when properly used in accordance with instructions for use provided in the labeling, can be reasonably expected to result in significant injury to the user.
2. A critical component is any component of a life support device or system whose failure to perform can be reasonably expected to cause the failure of the life support device or system, or to affect its safety or effectiveness.

PRODUCT STATUS DEFINITIONS

Definition of Terms

Datasheet Identification	Product Status	Definition
Advance Information	Formative or In Design	This datasheet contains the design specifications for product development. Specifications may change in any manner without notice.
Preliminary	First Production	This datasheet contains preliminary data, and supplementary data will be published at a later date. Fairchild Semiconductor reserves the right to make changes at any time without notice in order to improve design.
No Identification Needed	Full Production	This datasheet contains final specifications. Fairchild Semiconductor reserves the right to make changes at any time without notice in order to improve design.
Obsolete	Not In Production	This datasheet contains specifications on a product that has been discontinued by Fairchild semiconductor. The datasheet is printed for reference information only.