

215SP Series, 5x20 mm, Time-Lag Fuse

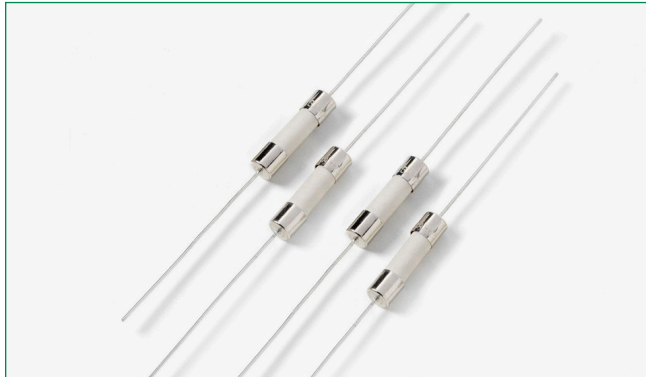

Description

The 215SP Series is a 5x20m Time-lag, surge withstanding ceramic body, axial-leaded cartridge fuse designed to IEC specifications.

Features

- High breaking capacity
- Meets Standard Sheet 5 of IEC 60127-2 as a Time-Lag fuse
- RoHS compliant and lead-free

Applications

Used as supplementary protection in appliance or utilization equipment to provide individual protection for components or internal circuits.

Agency Approvals

Agency	Agency File Number	Ampere Range
	NBK080205-E10480B NBK250702-E10480F	1A – 5A 6.3A – 10A
	CCC self-declaration No.: 2020970207000048	1A - 10A
	SU05001-2011B SU05001-10001 SU05001-10002 SU05001-2012B	1A – 2.5A 3.15A – 6.3A 8A 10A
	E10480	1A – 10A
	29862	1A – 10A
	40013521	1A – 8A
	J50248091	10A
	N/A	1A – 10A

Electrical Characteristics for Series

% of Ampere Rating	Ampere Rating	Opening Time
210%	1A - 3.15A	30 minutes, Maximum
	4A - 6.3A	30 minutes, Maximum
	8A - 10A	30 minutes, Maximum
275%	1A - 3.15A	0.75 sec. Min.; 80 secs. Max.
	4A - 6.3A	0.75 sec. Min.; 80 secs. Max.
	8A - 10A	0.75 sec. Min.; 80 secs. Max.
400%	1A - 3.15A	0.095 sec. Min.; 5 secs. Max.
	4A - 6.3A	0.150 sec. Min.; 5 secs. Max.
	8A - 10A	0.150 sec. Min.; 5 secs. Max.
1000%	1A - 3.15A	0.010 sec. Min.; .150 secs. Max.
	4A - 6.3A	0.010 sec. Min.; .150 secs. Max.
	8A - 10A	0.010 sec. Min.; .150 secs. Max.

Additional Information



Datasheet



Resources



Samples

Electrical Characteristic Specifications by Item

Amp Code	Amp Rating	Voltage Rating	Interrupting Rating**	Nominal Resistance Cold Ohms (Ohms)	Nominal Melting I ² t* (A ² sec)	Maximum Voltage Drop at Rated Current (mV)	Maximum Power Dissipation at 1.5In (W)	Agency Approvals							
001.	1	250	1500 A @ 250 VAC	0.1515	1.52000	350	2.5	x	x	x	x	x	x	-	x
1.25	1.25	250		0.1074	3.20000	300	2.5	x	x	x	x	x	x	-	x
01.6	1.6	250		0.0707	6.83000	200	2.5	x	x	x	x	x	x	-	x
002.	2	250		0.0566	11.68000	190	2.5	x	x	x	x	x	x	-	x
02.5	2.5	250		0.0386	22.29000	180	2.5	x	x	x	x	x	x	-	x
3.15	3.15	250		0.0283	43.25500	140	4	x	x	x	x	x	x	-	x
004.	4	250		0.0185	46.96000	100	4	x	x	x	x	x	x	-	x
005.	5	250		0.0153	66.09500	100	4	x	x	x	x	x	x	-	x
06.3	6.3	250		0.0108	128.75000	100	4	x	x	x	x	x	x	-	x
008.	8	250		0.0092	209.88000	100	4	x	x	x	x	x	x	-	x
010.	10	250		0.0066	333.56500	100	4	x	x	x	x	x	x	-	x

*I²t test at 10x rated current

** Interrupting Rating may differ based on Agency Approval. See Agency Approval certificate for more details.

Temperature Re-rating Curve

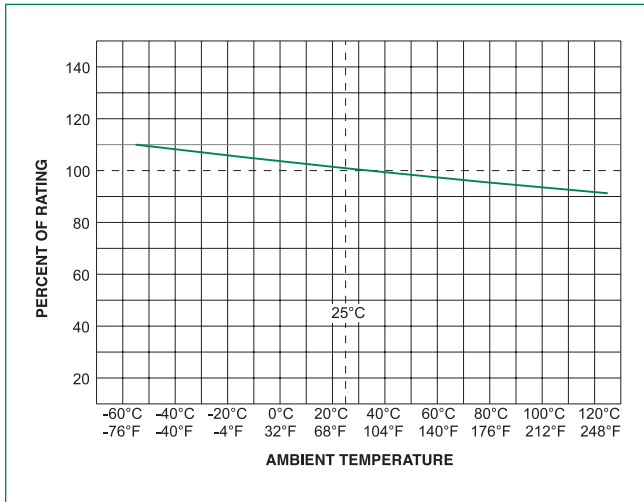

Average Time Current Curves

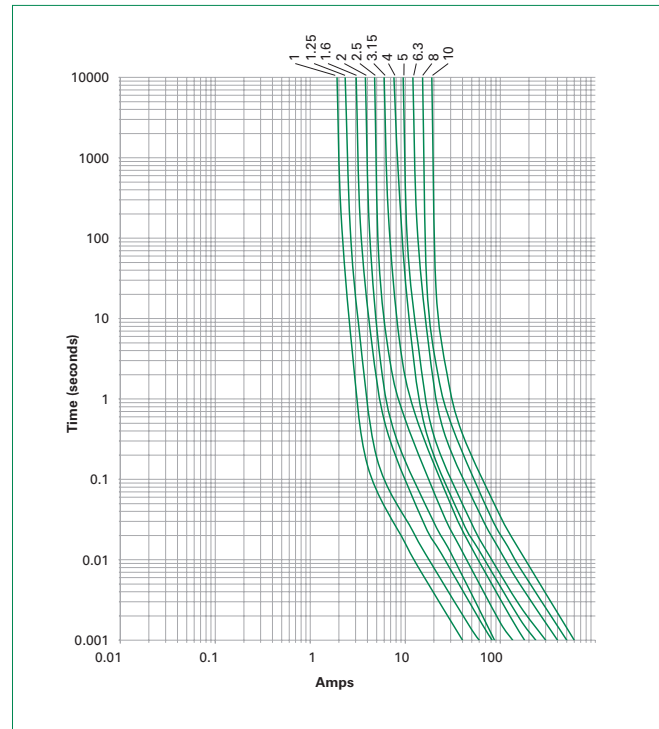

Soldering Parameters - Wave Soldering

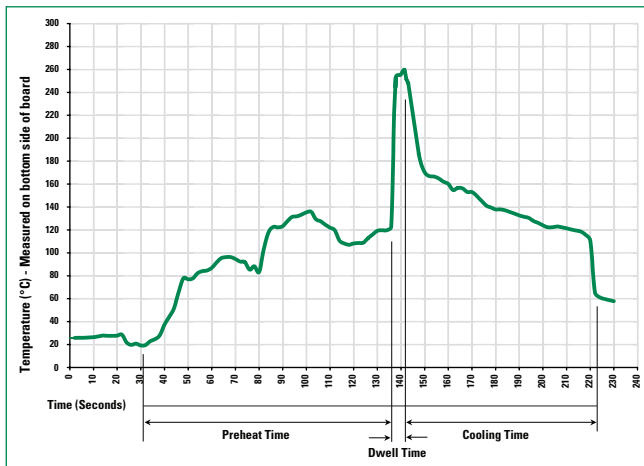

Recommended Process Parameters:

Wave Parameter	Lead-Free Recommendation
Preheat: (Depends on Flux Activation Temperature)	(Typical Industry Recommendation)
Temperature Minimum:	100°C
Temperature Maximum:	150°C
Preheat Time:	60-180 seconds
Solder Pot Temperature:	260°C Maximum
Solder Dwell Time:	2-5 seconds

Recommended Hand-Solder Parameters:

Solder Iron Temperature: 350°C +/- 5°C
Heating Time: 5 seconds max.

Note: These devices are not recommended for IR or Convection Reflow process.

Different values of A and B available, please contact the Littelfuse sales representative in your region:

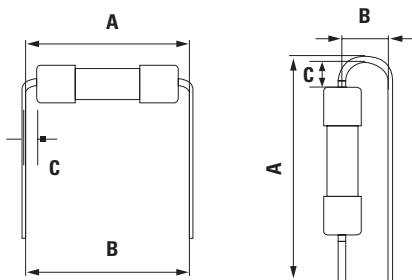

For the pigtailed fuse, please follow the recommendations below for axial lead forming and mounting into PCB:

Lead forming:

The distance C between cap flat surface and axial lead shall be greater than 1.0 mm.

PCB mounting:

The distance between PCB and fuse cap is recommended to be a minimum of 1.5 mm.

Product Characteristics

Materials	Body: Ceramic Cap: Nickel-plated Brass Leads: Tin-plated Copper
Terminal Strength	MIL-STD-202, Method 211, Test Condition A
Solderability	MIL-STD-202 Method 208
Product Marking	Cap 1: Brand logo, current and voltage ratings Cap 2: Agency approval marks
Operating Temperature	-55°C to +125°C
Thermal Shock	MIL-STD-202, Method 107, Test Condition B (5 cycles, -65°C to +125°C)
Vibration	MIL-STD-202, Method 201
Humidity	MIL-STD-202, Method 103, Test Condition A (High RH (95%) and elevated temp (40°C) for 240 hours)
Salt Spray	MIL-STD-202, Method 101, Test Condition B

Dimensions

All dimensions in mm

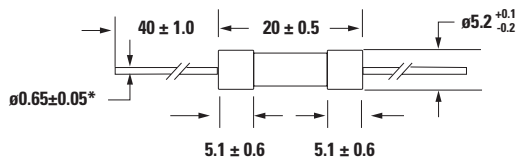

Notes:

* Ratings 8A and 10A have 0.8 ± 0.05 diameter lead.

Part Numbering System

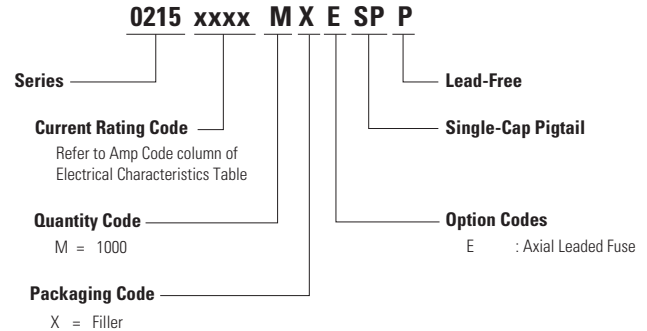

Packaging

Packaging Option	Packaging Specification	Quantity	Packaging Code	Reel Size
215SP Series				
Bulk	N/A	1000	MXE	N/A

Disclaimer Notice - Littelfuse products are not designed for, and shall not be used for, any purpose (including, without limitation, automotive, military, aerospace, medical, life-saving, life-sustaining or nuclear facility applications, devices intended for surgical implant into the body, or any other application in which the failure or lack of desired operation of the product may result in personal injury, death, or property damage) other than those expressly set forth in applicable Littelfuse product documentation. Warranties granted by Littelfuse shall be deemed void for products used for any purpose not expressly set forth in applicable Littelfuse documentation. Littelfuse shall not be liable for any claims or damages arising out of products used in applications not expressly intended by Littelfuse as set forth in applicable Littelfuse documentation. The sale and use of Littelfuse products is subject to Littelfuse Terms and Conditions of Sale, unless otherwise agreed by Littelfuse. Information furnished is believed to be accurate and reliable. However, users should independently evaluate the suitability of and test each product selected for their own applications. Littelfuse products are not designed for, and may not be used in, all applications. Read complete Disclaimer Notice at www.littelfuse.com/disclaimer-electronics.