



# EV2723-QC-00A

## 3A, I<sup>2</sup>C-Controlled SW Charger with NVDC Power Path and USB OTG Evaluation Board

### DESCRIPTION

The EV2723-QC-00A is an evaluation board for the MP2723, a 3A, highly integrated, switch-mode battery charger IC for single-cell Li-ion or Li-polymer batteries. This device supports NVDC architecture with power path management and is suitable for portable applications including tablets, mobile internet devices, and smartphones. Its low-impedance power path optimizes efficiency, reduces battery charging time, and extends battery life. The I<sup>2</sup>C serial interface can control the charging and system settings.

The EV2723-QC-00A supports 5V input sources, including standard USB host ports and wall adapters with fast charging capabilities.

The EV2723-QC-00A supports USB On-The-Go (OTG) operation by supplying 5V with 1.5A.

### ELECTRICAL SPECIFICATIONS

Parameter	Symbol	Value	Units
Input voltage	V <sub>IN</sub>	3.7 to 5.5	V
Charge full voltage	V <sub>BATT_REG</sub>	4.2, I <sup>2</sup> C-configurable	V
Charge current	I <sub>CC</sub>	1.916, I <sup>2</sup> C-configurable	A
Input voltage regulation	V <sub>IN_MIN</sub>	4.3, I <sup>2</sup> C-configurable	V
Input current limit	I <sub>IN_LIM</sub>	0.5, I <sup>2</sup> C-configurable	A
OTG voltage regulation	V <sub>IN_DSCHG</sub>	5.0, I <sup>2</sup> C-configurable	V
OTG current limit	I <sub>IN_DSCHG</sub>	0.5, I <sup>2</sup> C-configurable	A

### FEATURES

- 3.7V to 5V Operating Input Voltage Range
- Up to 22V Sustainable Voltage
- High-Efficiency 3A, 1.35MHz Buck Charger
  - D+/D- Detection for BC1.2
  - Adjustable Minimum Input Voltage Regulation for Maximum Power Point Tracking
- USB OTG with Adjustable 4.8V to 5.5V Output: Up to 1.5A Output with Selectable 1.35MHz Boost Converter
- Up to 9A Battery Discharge Current
- Integrated ADC for Monitoring Input Voltage, Input Current, Battery Voltage, Charge Current, System Voltage, and Battery Temperature
- NVDC Power Path Management
  - Instant On Works with No Battery or Deeply Discharged Battery
  - Ideal Diode Operation in Battery Supplement Mode
- I<sup>2</sup>C Port for Flexible System Parameter Setting and Status Reporting
- Full DISC Control to Support Shipping Mode and System Restart
- High Accuracy
  - ±0.5% Charge Voltage Regulation
  - ±5% Charge Current Regulation
  - ±5% Input Current Regulation
  - ±2% Output Regulation in Boost Mode
- Safety Features Include Configurable JEITA for Battery Temperature Protection, Battery Charging Safety Timer, Thermal Regulation and Thermal Shutdown, Input/System Over-Voltage Protection, Battery Temperature Protection
- Charging Operation Indicator

### APPLICATIONS

- Tablet PCs
- Smartphones
- Mobile Internet Devices

All MPS parts are lead-free, halogen-free, and adhere to the RoHS directive. For MPS green status, please visit the MPS website under Quality Assurance. "MPS", the MPS logo, and "Simple, Easy Solutions" are trademarks of Monolithic Power Systems, Inc. or its subsidiaries.

**EVALUATION BOARD**

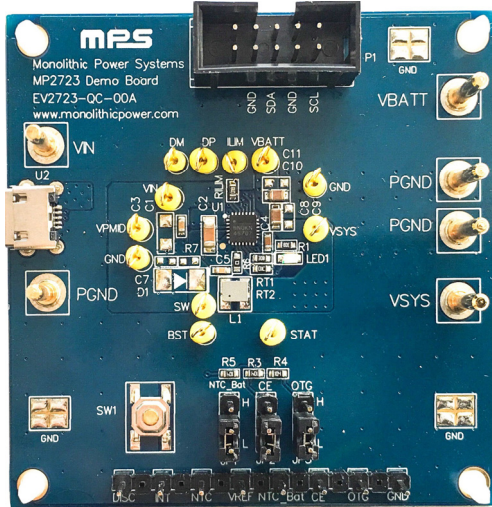

(LxWxH) 6.3cmx6.3cmx1.3cm

Board Number	MPS IC Number
EV2723-QC-00A	MP2723GQC-0000

**Efficiency vs. Charge Current**  
 $V_{IN}=5V, V_{BATT}=3.8V, R_{L\_DCR}=21m\Omega$

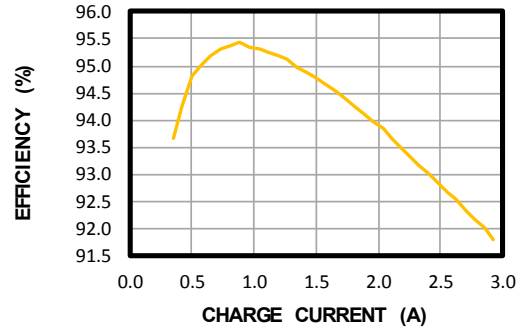

## QUICK START GUIDE

The EV2723-QC-00A is designed for the MP2723 when the MP2723 is used as a standalone switching charger with integrated USB detection and USB On-the-Go (OTG) functionality. Its layout accommodates most commonly used capacitors. The default function of this board is preset for charger mode, and the charge-full voltage is preset to 4.2V for single-cell Li-ion batteries. The EV2723-QC-00A can be used with multiple jumper connections for different functions (see Table 1).

**Table 1: Jumper Connections**

Jack	Description	Factory Settings
JP3	Pull the OTG pin high to enable On-the-Go (OTG) mode	Pull low
JP2	Pull the CE pin low to enable charging	Pull low
JP1	Pull the NTC pin low to set NTC at a fixed 50% ratio	Pull low
P1	I <sup>2</sup> C connector	N/A

### Evaluation Platform Preparation

The EV2723-QC-00A requires at least one USB port and a USB cable. The MP2723 evaluation software must be properly installed, and an evaluation kit (EVKT-USBI2C-02) must be used to connect the USB and I<sup>2</sup>C (see Figure 1).



**Figure 1: USB to I<sup>2</sup>C Communication Kit**

The MP2723 evaluation kit .exe file can be downloaded from MPS website. Double-click on the “MP2723 Evaluation Kit” .exe file to run the MP2723 evaluation software. The software supports Windows XP, Windows 7, and later operating systems. Figure 2 shows a recommended test set-up.

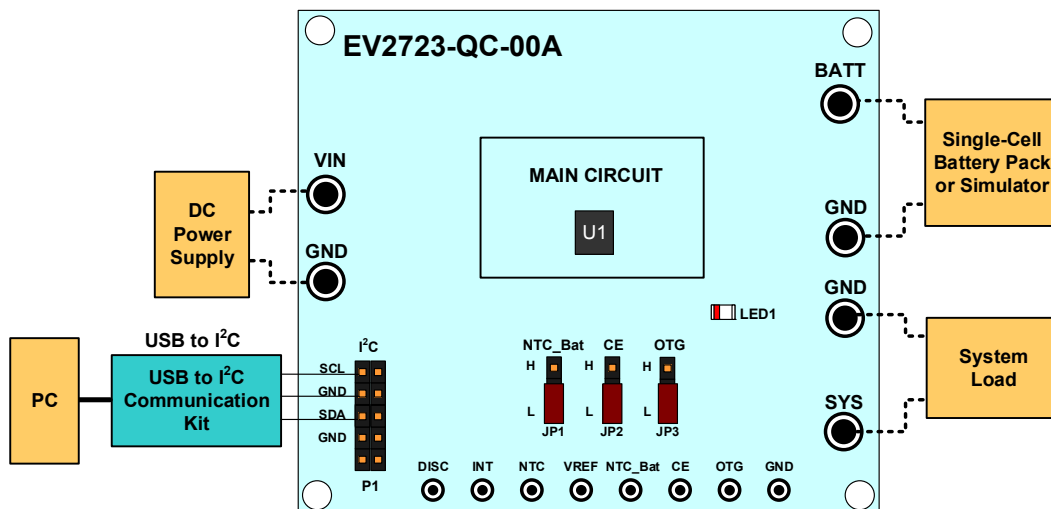

**Figure 2: Test Set-Up for the MP2723**

To use the software, follow the steps below:

1. Turn on the computer, and launch the MP2723 evaluation software. The software’s main window should appear (see Figure 3).
  - The status “USB: Connected” indicates a successful USB connection.
  - That status “MP2723 Demo board: Connected” indicates a successful EVB2723-QC-00A connection.

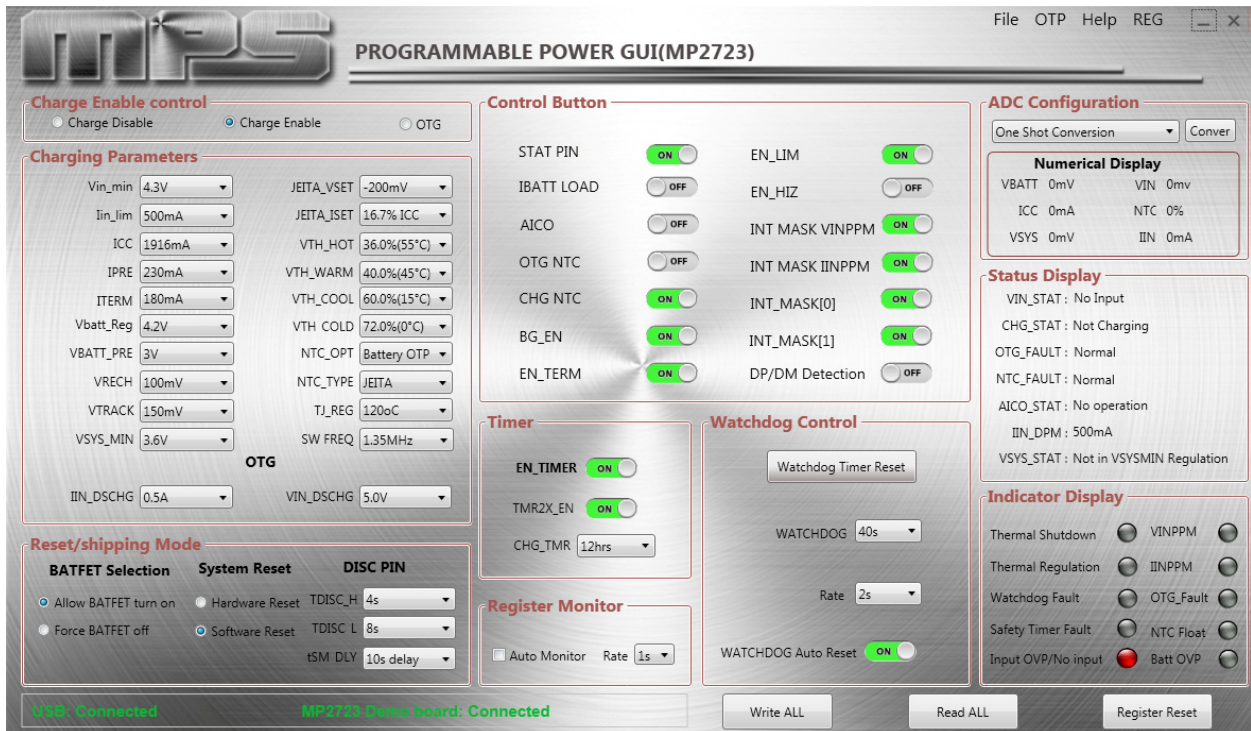
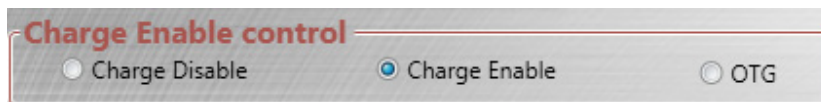

**Figure 3: The MP2723 Evaluation Software**

## Procedures

To set the parameters for the MP2723, following the steps below:

1. Ensure that the all components are connected before running the program, and the status in the lower-left side of the GUI is indicated in green (see Figure 3).
2. Select the operation mode for the MP2723 (see Figure 4).



**Figure 4: Selecting the Operation Mode**

3. Select the charger functions (see Figure 5).

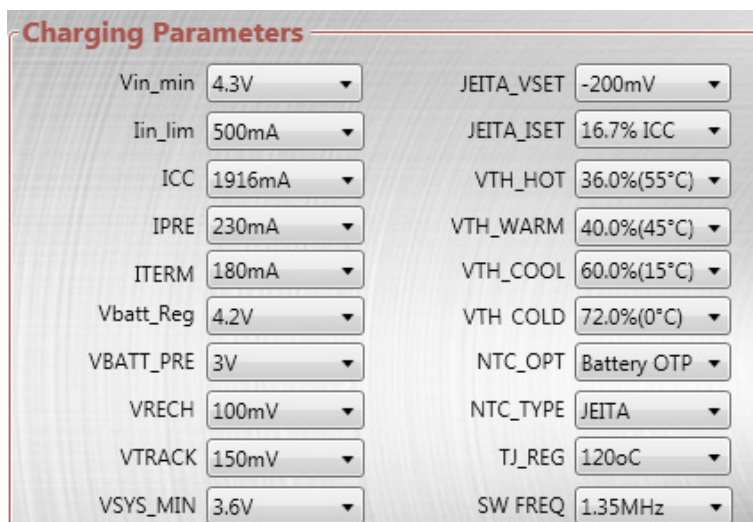

**Figure 5: Selecting the Charger Functions**

- Set the input voltage regulation threshold between 3.7V and 5.2V.
  - The default value is 4.3V. Set the voltage regulation threshold according to the V<sub>BATT\_REG</sub> setting. For example, if V<sub>BATT\_REG</sub> is set to 4.35V, the voltage regulation threshold value is recommended to be set to 4.6V or greater (see Figure 6).

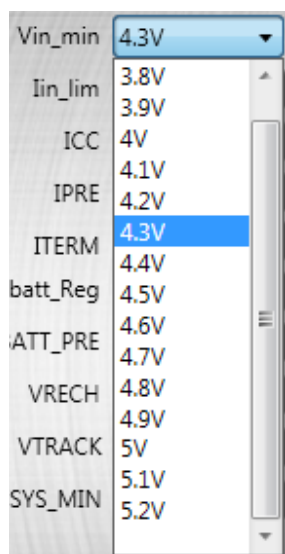

**Figure 6: Setting the Input Voltage Regulation Threshold**

- Set the input current limit between 100mA and 3250mA.
  - The default value is 500mA. Set the input current limit so that it meets the input source capacity (see Figure 7).

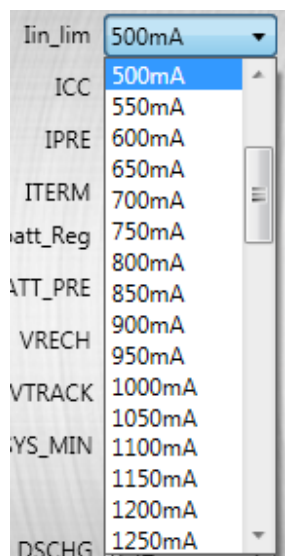

**Figure 7: Setting the Input Current Limit**

- The input current limit can be set below the maximum current rating of the input source. When the input current reaches the limit, the charge current decreases to keep the input current constant at this limit. This protects the power system.
6. Set the constant charge current between 320mA and 2966mA.
- The default charge current is set at 1916mA. The actual charge current is limited at the input current limit setting (see Figure 8).

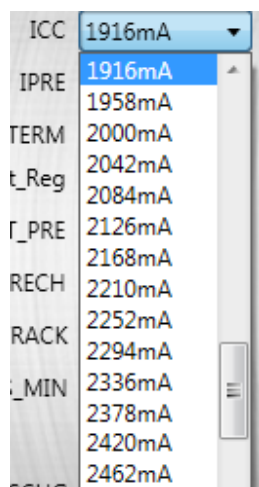

**Figure 8: Setting the Constant Charger Current**

7. Set the pre-charge current between 150mA and 750mA.
- The default value is 230mA (see Figure 9).

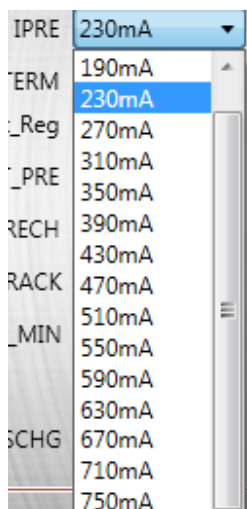

**Figure 9: Setting the Pre-Charge Current**

8. Set the termination charge current between 100mA and 700mA.
  - The default value is 180mA (see Figure 10).

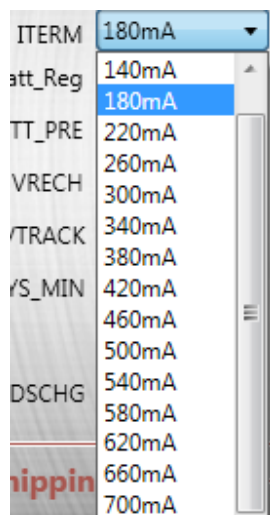

**Figure 10: Setting the Termination Charge Current**

9. Set the charge full voltage between 3.4V and 4.67V.
  - The default value is 4.2V (see Figure 11).

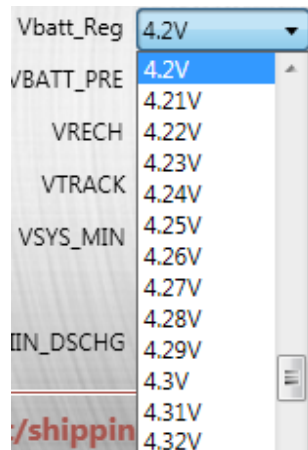

**Figure 11: Setting the Charge Full Voltage**

10. Set the pre-charge to constant current charge threshold voltage between 2.8V and 3.0V.

- The default value is 3.0V (see Figure 12).

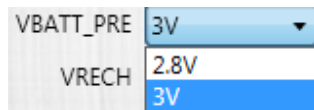

**Figure 12: Setting Threshold Voltages**

11. Set the battery's auto-recharge voltage to  $V_{BATT\_REG}$  minus the set value. This range is between 100mV and 200mV.

- The default value is 100mV (see Figure 13).

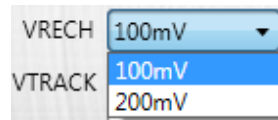

**Figure 13: Setting the Auto-Recharge Voltage**

12. Set the voltage variation between SYS regulation voltage and  $V_{SYS\_MIN}$ . This range is between 100mV and 150mV.

- The default value is 150mV (see Figure 14).

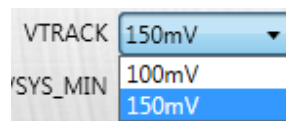
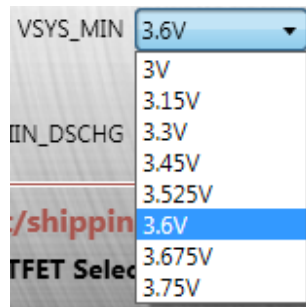

**Figure 14: Setting Voltage Variation**

13. Set the  $V_{SYS\_MIN}$  voltage threshold between 3V and 3.75V.

- The default value is 3.6V (see Figure 15).

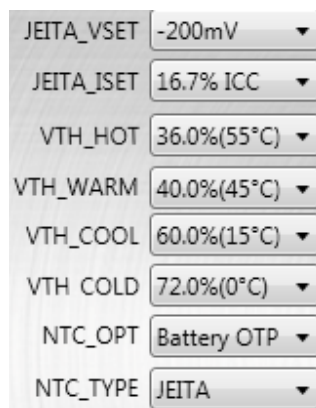



**Figure 15: Setting the V<sub>sys\_min</sub> Threshold**

14. Set the NTC function according to the selected NTC thermistor and its requirements.

- If this function is not required during the evaluation, leave it at the default setting (see Figure 16).



**Figure 16: Setting the NTC Function**

15. Set the thermal regulation threshold between 60°C and 120°C.

- The default value is 120°C (see Figure 17).

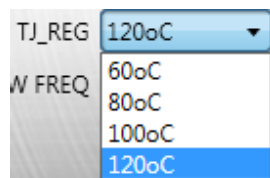

**Figure 17: Setting the Thermal Regulation Threshold**

16. Set the switching (SW) frequency between 1.35MHz and 1MHz.

- The default value is 1.35MHz (see Figure 18).

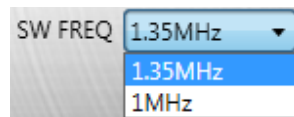

**Figure 18: Setting the SW Frequency**

17. Set the charge timer between 5hrs and 20hrs.

- The default value is 12hrs (see Figure 19).

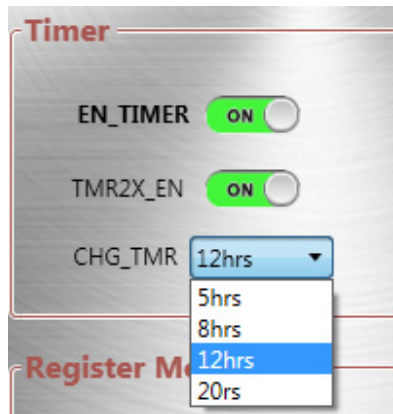

**Figure 19: Setting the Charge Timer**

- The integrated charge timer provides backup protection to prevent a damaged battery from being charged after a certain time. The timer function can be disabled.

**Boost Mode**

When the MP2723 is programmed to On-the-Go (OTG) mode, the output voltage and current limit can be controlled via the I<sup>2</sup>C. In this situation, follow the steps below:

1. Turn off and disconnect the power at VIN to PGND.
2. If the constant voltage load connected from BATT+ to GND is not a four-quadrant supply (sources current), remove the load. Use the power source that was disconnected in step 1, set it to 4.0V with a 3.5A current limit, then connect the power source between BATT+ and PGND.
3. Apply resistor (5W or greater, R = 4Ω to 10Ω) across VIN (+) to PGND (-).
4. Pull JP3 high, and select OTG in the menu (see Figure 20).

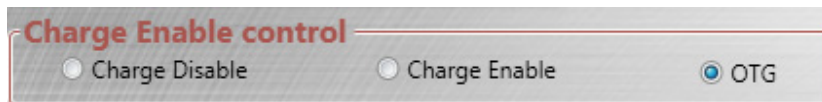

**Figure 20: Selecting On-the-Go (OTG) Mode**

5. Set the OTG output voltage regulation threshold between 4.8V and 5.5V.
  - The default value is 5.0V (see Figure 21).

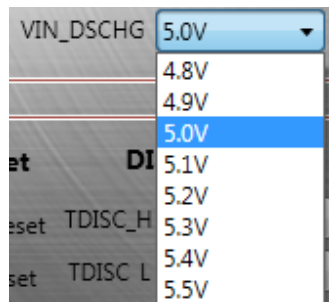

**Figure 21: Setting the OTG Output Voltage Regulation**

6. Set the OTG current limit between 0.5A and 1.5A.
  - The default value is 0.5A (see Figure 22).

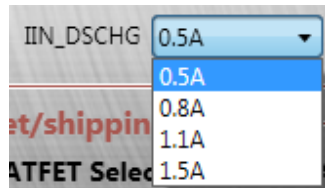

**Figure 22: Setting the OTG Current Limit**

**Other Modes**

Figure 23 shows shipping mode control.

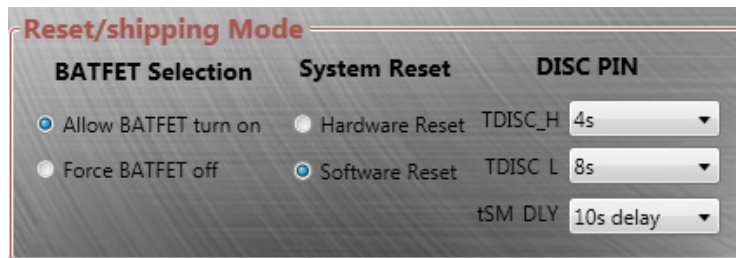

**Figure 23: Shipping Mode Control**

Figure 24 shows additional adjustable parameters.

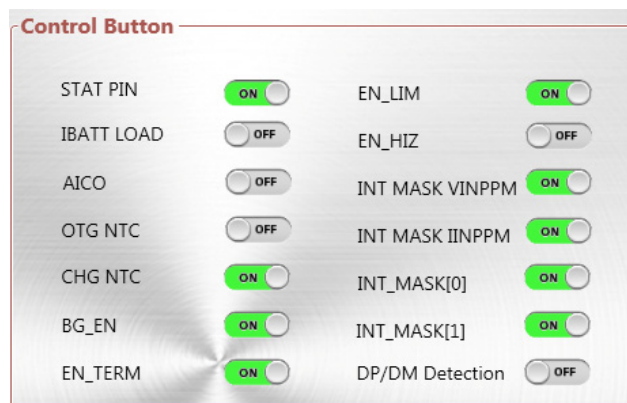

**Figure 24: Adjustable Parameters for the MP2723**

Figure 25 shows watchdog control.

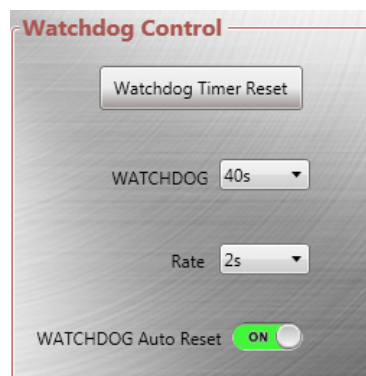

**Figure 25: Watchdog Control**

Figure 26 shows register auto-monitoring.

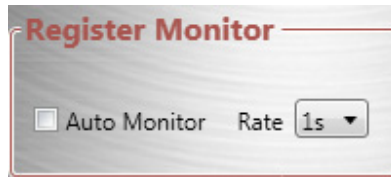

**Figure 26: Register Auto-Monitoring**

Figure 27 shows ADC configuration.

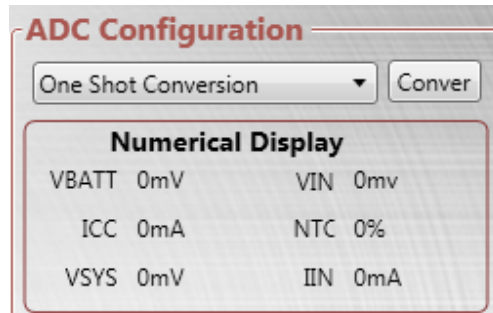

**Figure 27: ADC Configuration**

Figure 28 shows how to monitor the MP2723 operation status and fault report.

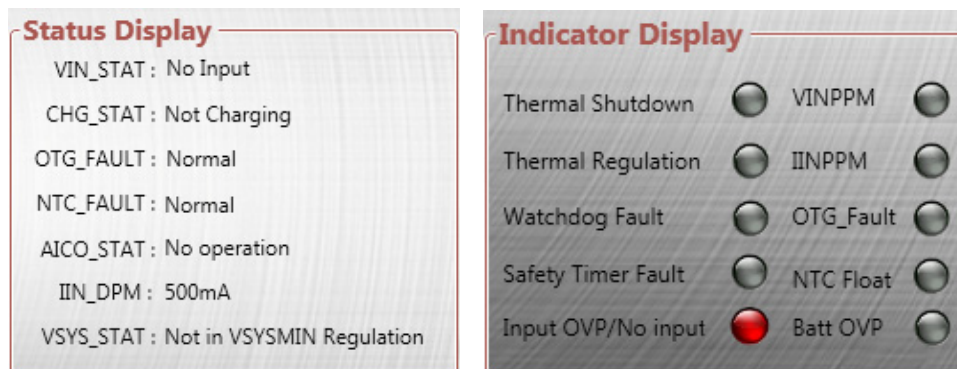

**Figure 28: Monitoring the MP2723 Status and Faults**

**EVALUATION BOARD SCHEMATIC**

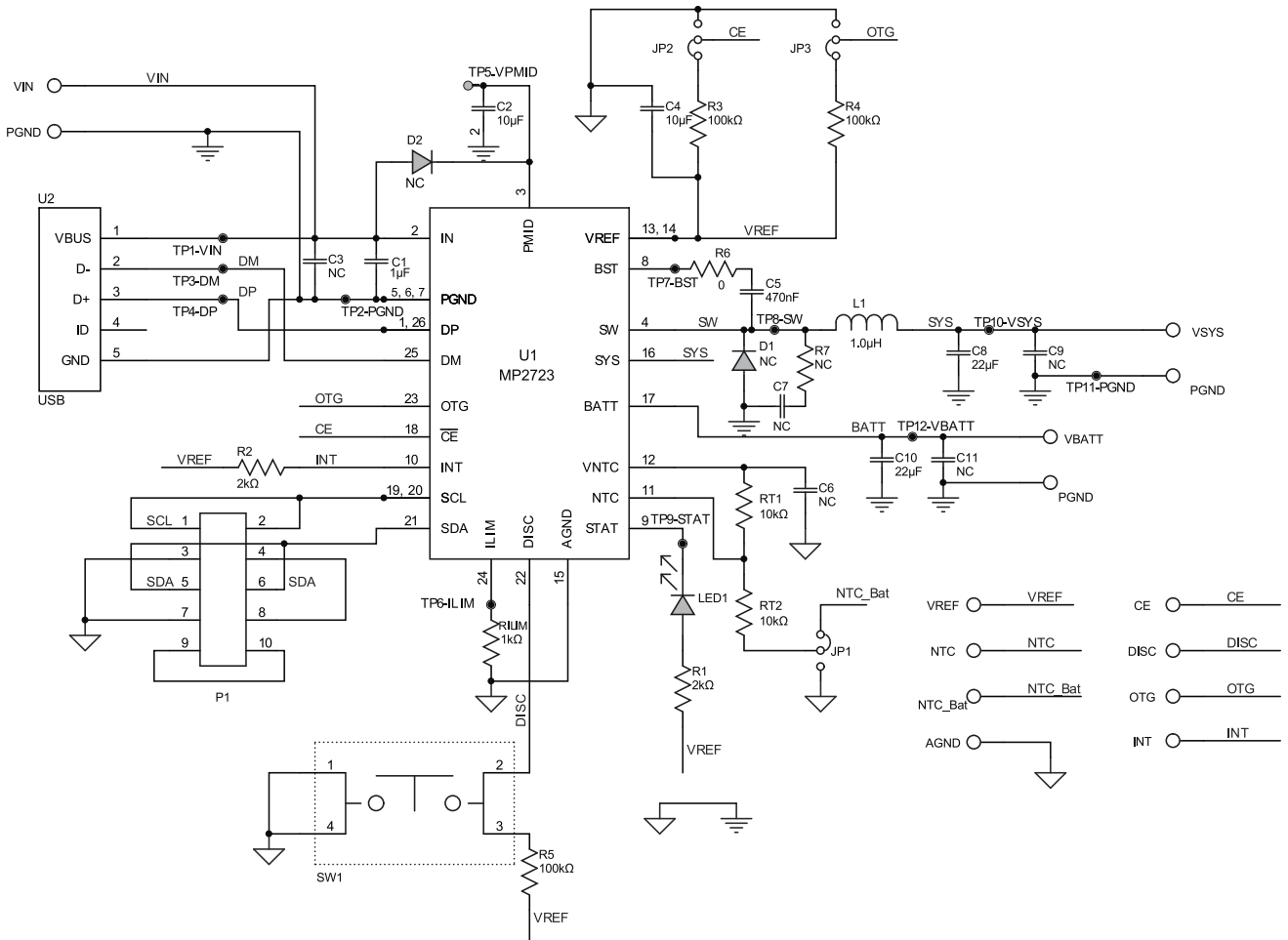

**Figure 29: Evaluation Board Schematic**

## BILL OF MATERIALS

Qty	Ref	Value	Description	Package	Manufacturer	Manufacturer P/N
1	C1	1 $\mu$ F	Ceramic capacitor, 25V, X7R, 0603	0603	muRata	GRM188R71E105KA12D
1	C2	10 $\mu$ F	Ceramic capacitor, 50V, X5R, 1206	1206	muRata	GRM31CR61H106KA12L
1	C3	NC	Ceramic capacitor, 50V, X5R, 1206	1206	muRata	
1	C4	10 $\mu$ F	Ceramic capacitor, 16V, X5R, 0603	0603	muRata	GRM188R61C106KAALD
1	C5	47nF	Ceramic capacitor, 50V, X7R, 0603	0603	muRata	GRM188R71H473KA61D
2	C6, C7	NC	Ceramic capacitor, 16V, X5R, 0603	0603	muRata	
2	C8, C10	22 $\mu$ F	Ceramic capacitor, 16V, X5R, 0805	0805	muRata	GRM21BR61C226ME44L
2	C9, C11	NC	Ceramic capacitor, 16V, X5R, 0805	0805	muRata	
2	D1, D2	NC	Diode, 50V, 3A	SMA	HQ	
1	L1	1.0 $\mu$ H	Inductor, 1.0 $\mu$ H	SMD	Cyntec	HTEP32251B-1R0MIR-89
1	LED1	RED	BL-HUF35A-TRB	0805	Bright LED	BL-HUF35A-TRB
2	R1, R2	2k $\Omega$	Film resistor, 1%	0603	Yageo	RC0603FR-072KL
3	R3, R4, R5	100k $\Omega$	Film resistor, 5%	0603	Yageo	RC0603JR-07100KL
1	R6	0 $\Omega$	Film resistor, 1%	0603	Yageo	RC0603FR-070RL
1	R7	NC	Film resistor, 1%	0603	Yageo	
1	RILIM	1k $\Omega$	Film resistor, 1%	0603	Yageo	RC0603FR-071KL
2	RT1, RT2	10k $\Omega$	Film resistor, 1%	0603	Yageo	RC0603FR-0710KL
1	SW1		Button, SM 4mmx10mm, 1.5mm height			
3	JP1, JP2, JP3		2.54mm connector			
3	JP1, JP2, JP3		2.54mm connector, shorter			
1	P1		Header, 5-pin, dual row			
8	DISC, VREF, AGND, OTG, CE, INT, NTC, NTC_Bat,		2.54mm connector			

**BILL OF MATERIALS (continued)**

Qty	Ref	Value	Description	Package	Manufacturer	Manufacturer P/N
12	DM, DP, VBATT, GND, VSYS, BST, STAT, SW, VPMID, GND, VIN, ILIM		Test point (yellow)			
6	VIN, PGND, VBATT, PGND, PGND, VSYS		2mm			
1	U1	MP2723	3A I <sup>2</sup> C-controlled SW charger	QFN-26 (3.5mmx3.5mm)	MPS	MP2723GQC- 0000
1	U2	Micro- USB	Micro-USB	DIP	Wurth	629105150521

## EVB TEST RESULTS

V<sub>IN</sub> = 5.0V, V<sub>BATT</sub> = full range, I<sup>2</sup>C-controlled, I<sub>CC</sub> = 1.916A, I<sub>IN\_LIM</sub> = 3250mA, V<sub>IN\_MIN</sub> = 4.3V, T<sub>A</sub> = 25°C, L<sub>1</sub> = 1.0μH, C<sub>BATT</sub> = 22μF, C<sub>SYS</sub> = 22μF, C<sub>IN</sub> = 1μF, C<sub>PMID</sub> = 10μF, unless otherwise noted.

### Battery Charge Curve

V<sub>IN</sub> = 5V, V<sub>BATT\_REG</sub> = 4.2V, I<sub>SYS</sub> = 0A

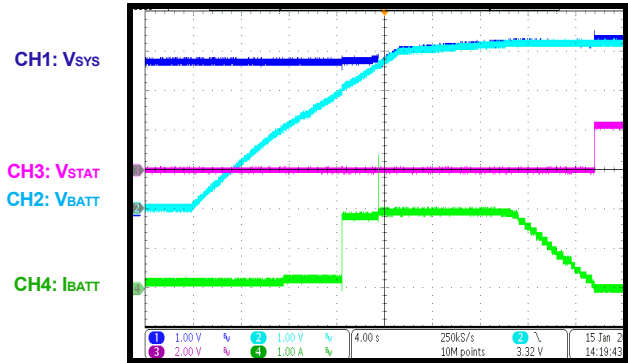

### Auto-Recharge

V<sub>IN</sub> = 5V, V<sub>BATT\_REG</sub> = 4.2V, I<sub>SYS</sub> = 0A

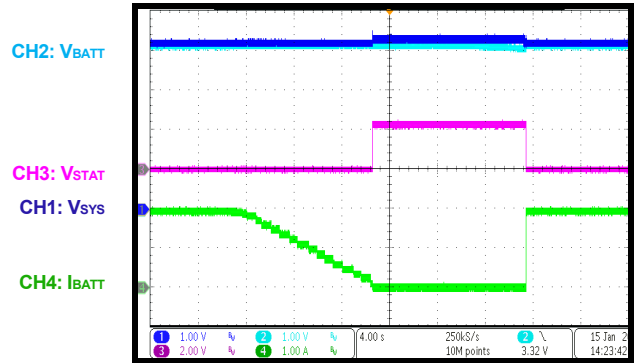

### Trickle Charge

V<sub>IN</sub> = 5V, V<sub>BATT</sub> = 1.0V, I<sub>SYS</sub> = 500mA

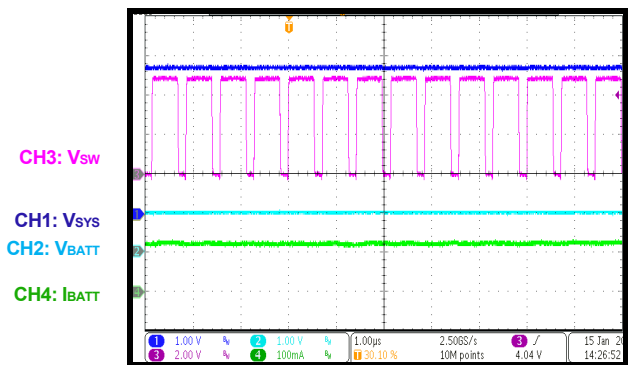

### Pre-Charge

V<sub>IN</sub> = 5V, V<sub>BATT</sub> = 2.5V, I<sub>PRE</sub> = 680mA

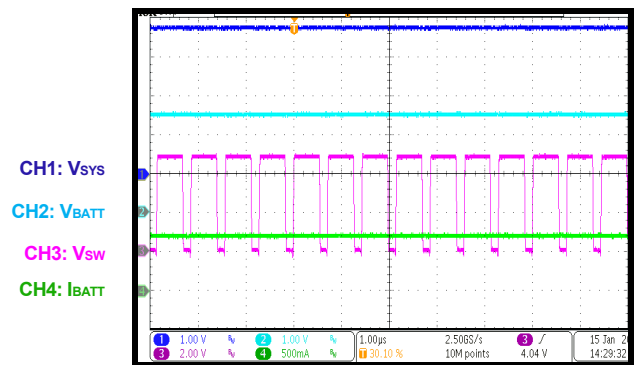

### Constant Current Charge

V<sub>IN</sub> = 5V, V<sub>BATT</sub> = 3.3V, I<sub>CC</sub> = 1916mA

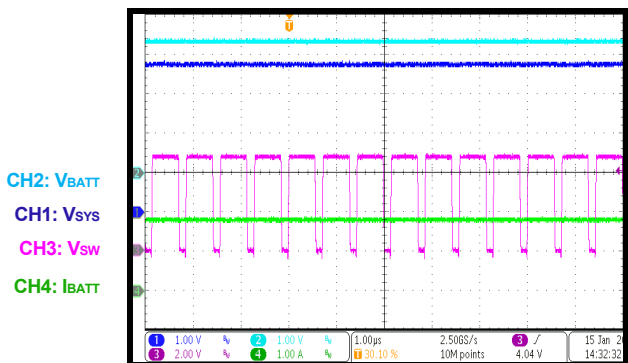

### Constant Current Charge

V<sub>IN</sub> = 5V, V<sub>BATT</sub> = 3.8V, I<sub>CC</sub> = 1916mA

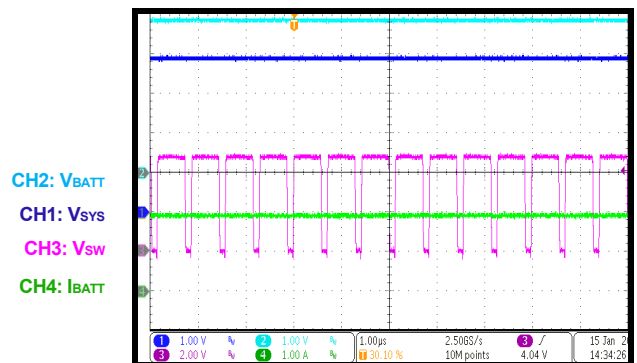



**EVB TEST RESULTS (continued)**

V<sub>IN</sub> = 5.0V, V<sub>BATT</sub> = full range, I<sup>2</sup>C-controlled, I<sub>CC</sub> = 1.916A, I<sub>IN\_LIM</sub> = 3250mA, V<sub>IN\_MIN</sub> = 4.3V, T<sub>A</sub> = 25°C, L1 = 1.0μH, C<sub>BATT</sub> = 22μF, C<sub>SYS</sub> = 22μF, C<sub>IN</sub> = 1μF, C<sub>PMID</sub> = 10μF, unless otherwise noted.

**Battery Supplement Mode**

V<sub>IN</sub> = 5V, V<sub>BATT</sub> = 3.8V, I<sub>SYS</sub> = 4.5A

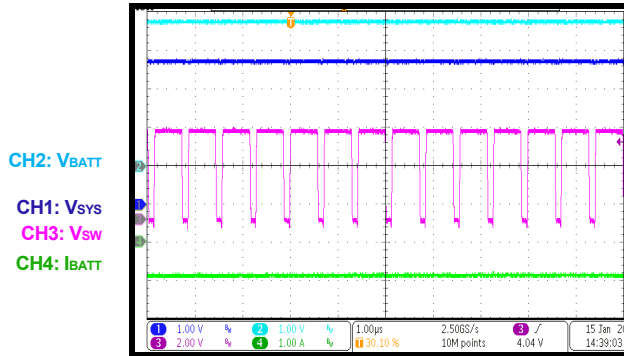

**Constant Voltage Charge**

V<sub>IN</sub> = 5V, V<sub>BATT</sub> = 4.19V, I<sub>SYS</sub> = 0A

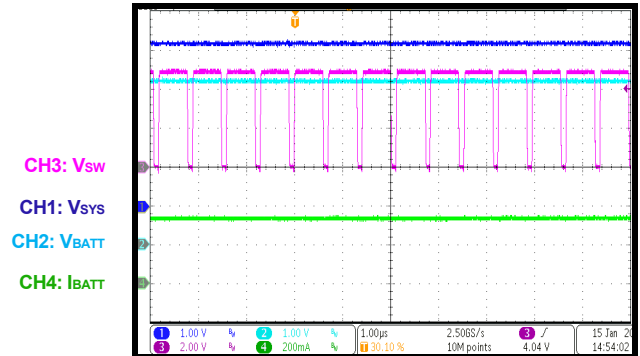

**Input Current Limit**

V<sub>IN</sub> = 5V, V<sub>BATT</sub> = 3.8V, I<sub>IN\_LIM</sub> = 1800mA

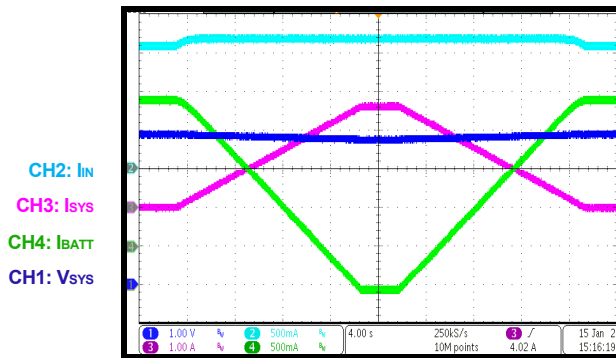

**Input Voltage Limit**

V<sub>IN</sub> = 5V (2A), V<sub>BATT</sub> = 3.3V, V<sub>IN\_MIN</sub> = 4.6V

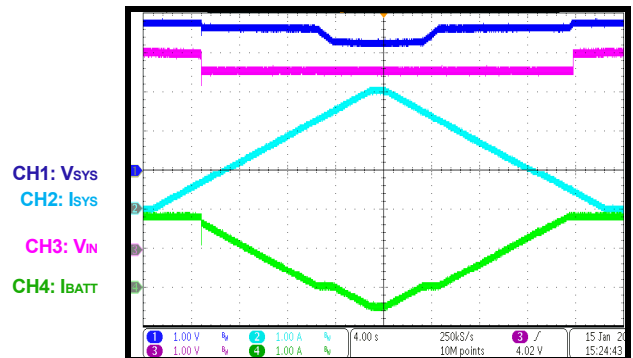

**Power-On/Off Waveform**

V<sub>IN</sub> = 5V, I<sub>IN\_LIM</sub> = 500mA, V<sub>BATT</sub> = 3.8V, I<sub>SYS</sub> = 2.5A

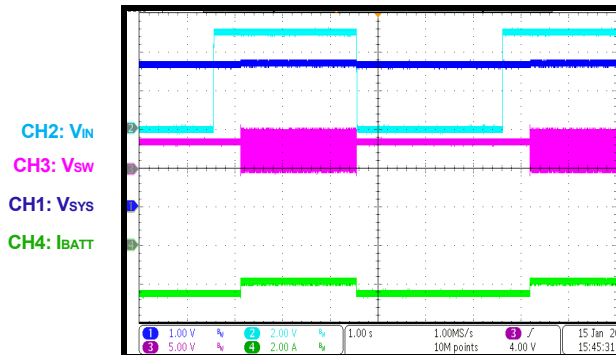

**Power-On/Off Waveform**

V<sub>IN</sub> = 5V, I<sub>IN\_LIM</sub> = 500mA, V<sub>BATT</sub> = 3.3V, I<sub>SYS</sub> = 0.5A

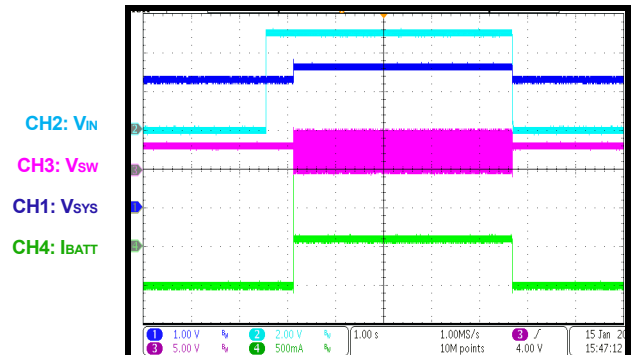

**EVB TEST RESULTS (continued)**

V<sub>IN</sub> = 5.0V, V<sub>BATT</sub> = full range, I<sup>2</sup>C-controlled, I<sub>CC</sub> = 1.916A, I<sub>IN\_LIM</sub> = 3250mA, V<sub>IN\_MIN</sub> = 4.3V, T<sub>A</sub> = 25°C, L<sub>1</sub> = 1.0μH, C<sub>BATT</sub> = 22μF, C<sub>SYS</sub> = 22μF, C<sub>IN</sub> = 1μF, C<sub>PMID</sub> = 10μF, unless otherwise noted.

**Suspend Mode On/Off**

V<sub>IN</sub> = 5V, I<sub>IN\_LMT</sub> = 500mA, V<sub>BATT</sub> = 4.0V, I<sub>SYS</sub> = 0.5A

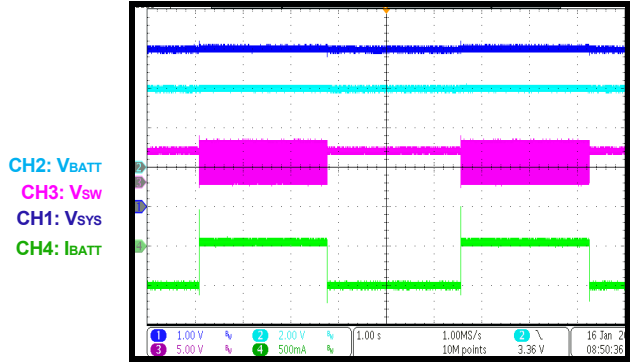

**Charge On/Off**

V<sub>IN</sub> = 5V, V<sub>BATT</sub> = 4.0V, I<sub>SYS</sub> = 0A

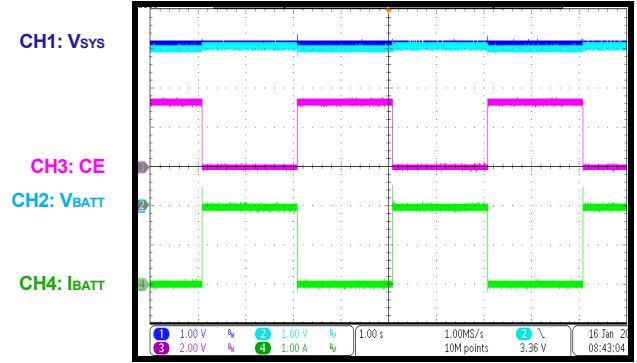

**BATFET On/Off**

V<sub>IN</sub> = 5V, V<sub>BATT</sub> = 4.0V, I<sub>SYS</sub> = 4A

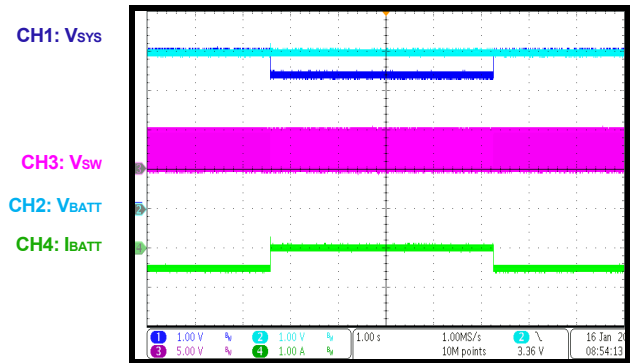

**VIN Hot Insertion/Removal**

V<sub>IN</sub> = 5V, I<sub>IN\_LMT</sub> = 500mA, V<sub>BATT</sub> = 3.3V, I<sub>SYS</sub> = 0.5A

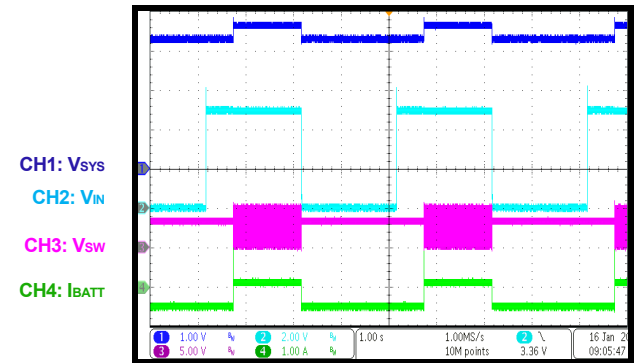

**SYS Load Transient**

V<sub>IN</sub> = 5V, V<sub>BATT</sub> = 3.3V, charge disabled, I<sub>SYS</sub> = 1A to 3A

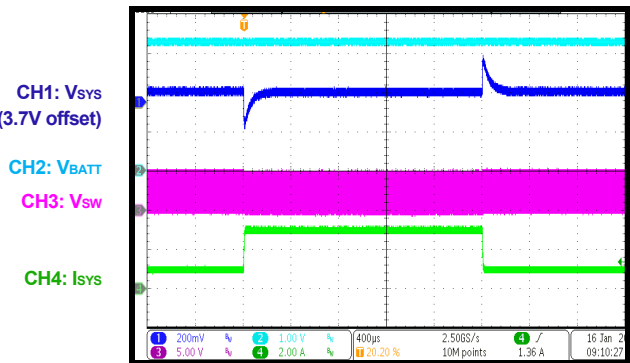

**VIN OVP Test**

V<sub>IN</sub> = 5V to 7V, V<sub>BATT</sub> = 3.8V, I<sub>SYS</sub> = 1A

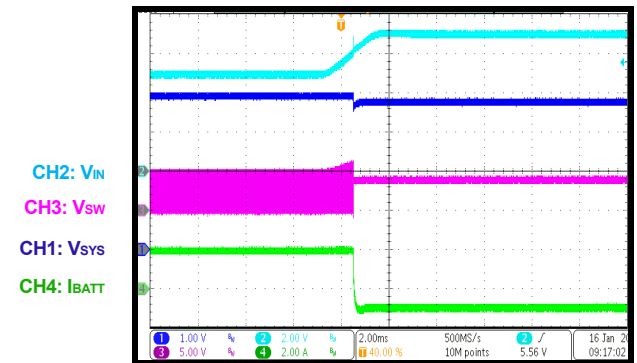

**EVB TEST RESULTS (continued)**

V<sub>IN</sub> = 5.0V, V<sub>BATT</sub> = full range, I<sup>2</sup>C-controlled, I<sub>CC</sub> = 1.916A, I<sub>IN\_LIM</sub> = 3250mA, V<sub>IN\_MIN</sub> = 4.3V, T<sub>A</sub> = 25°C, L<sub>1</sub> = 1.0μH, C<sub>BATT</sub> = 22μF, C<sub>SYS</sub> = 22μF, C<sub>IN</sub> = 1μF, C<sub>PMID</sub> = 10μF, unless otherwise noted.

**System Reset Mode**

V<sub>IN</sub> = float, V<sub>BATT</sub> = 3.8V, I<sub>SYS</sub> = 2A

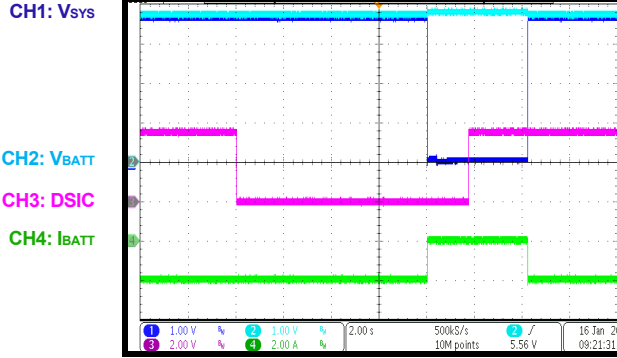

**Battery Discharge Current**

V<sub>IN</sub> = float, V<sub>BATT</sub> = 4.0V, I<sub>SYS</sub> = 9.5A maximum

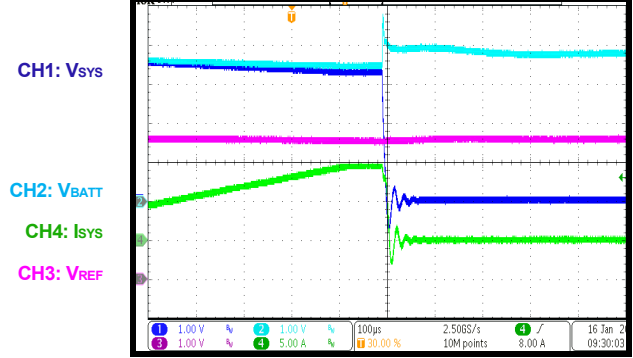

**OTG Mode On**

V<sub>IN</sub> = float, OTG mode, V<sub>BATT</sub> = 3.3V, I<sub>IN\_DSCHG</sub> = 0.5A, I<sub>OTG</sub> = 0.5A

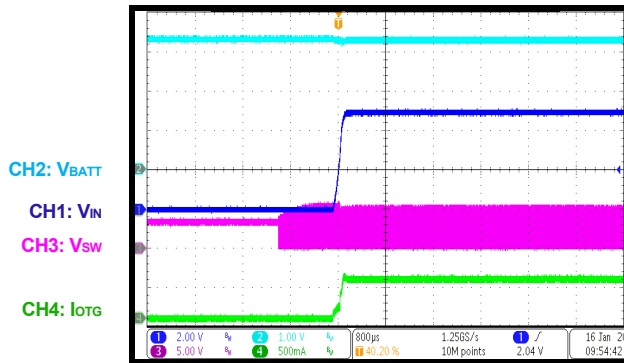

**OTG Steady State Operation**

V<sub>IN</sub> = float, OTG mode, V<sub>BATT</sub> = 4.0V, I<sub>IN\_DSCHG</sub> = 1.5A, I<sub>OTG</sub> = 1A

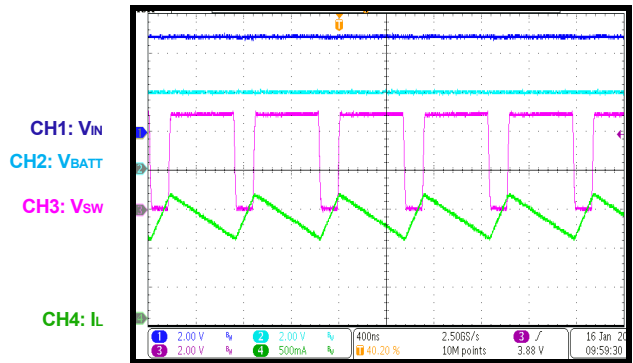

**OTG Voltage Regulation**

V<sub>IN</sub> = float, OTG mode, V<sub>BATT</sub> = 4.0V, I<sub>IN\_DSCHG</sub> = 1.5A, I<sub>OTG</sub> = 0A to 1.5A

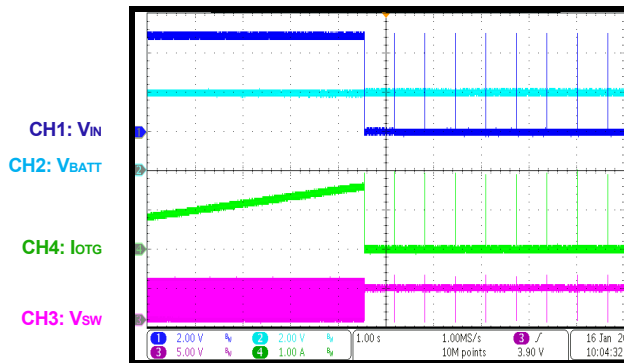

**NTC JEITA Operation**

V<sub>IN</sub> = 5V, V<sub>BATT</sub> = 4.09V, I<sub>sys</sub> = 0A, JEITA\_ISET = 50%, JEITA\_VSET = -100mV

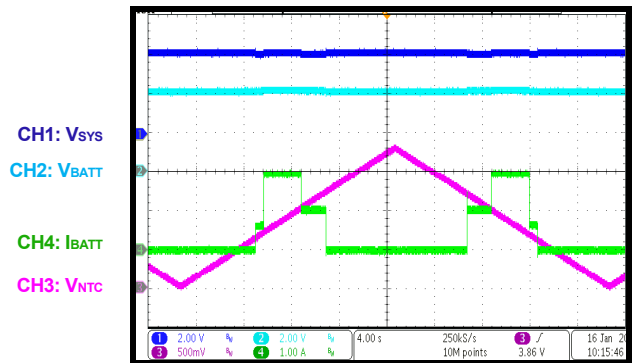

**PCB LAYOUT**

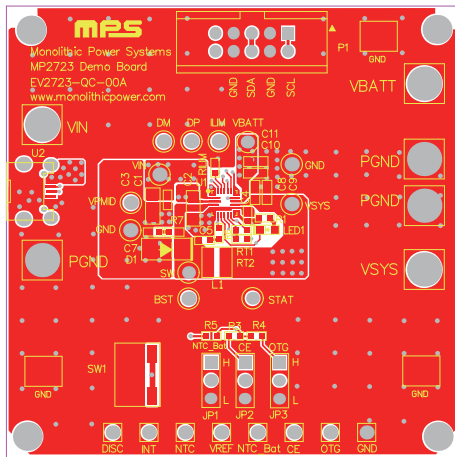

**Figure 30: Top Layer**

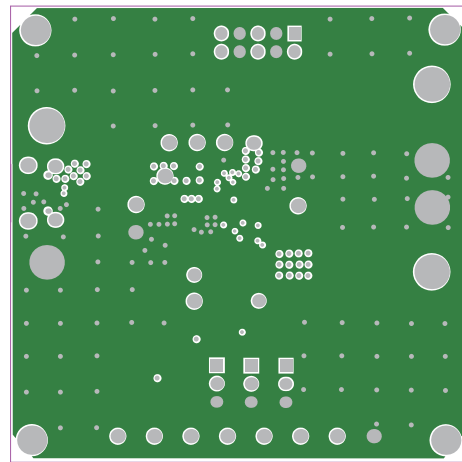

**Figure 31: Mid-Layer 1**

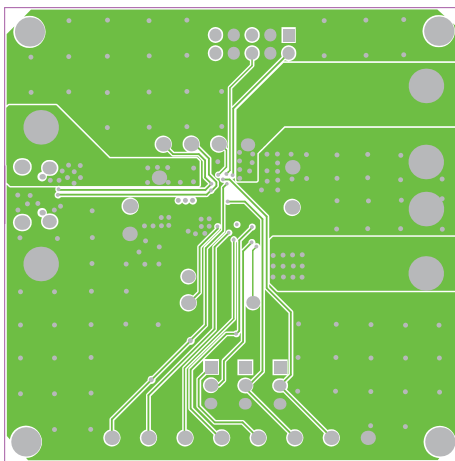

**Figure 32: Mid-Layer 2**

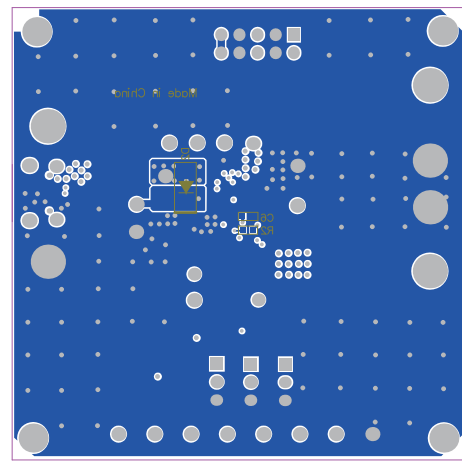

**Figure 33: Bottom Layer**

**Notice:** The information in this document is subject to change without notice. Please contact MPS for current specifications. Users should warrant and guarantee that third-party Intellectual Property rights are not infringed upon when integrating MPS products into any application. MPS will not assume any legal responsibility for any said applications.