

H11AA1, H11AA3, H11AA2, H11AA4 AC Input/Phototransistor Optocouplers

Features

- Bi-polar emitter input
- Built-in reverse polarity input protection
- Underwriters Laboratory (UL) recognized – File #E90700
- VDE approved – File #E94766 (ordering option '300')

Applications

- AC line monitor
- Unknown polarity DC sensor
- Telephone line interface

Description

The H11AAX series consists of two gallium-arsenide infrared emitting diodes connected in inverse parallel driving a single silicon phototransistor output.

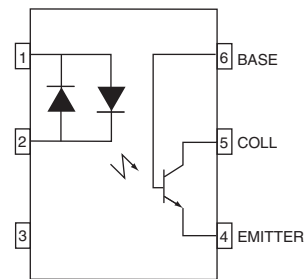
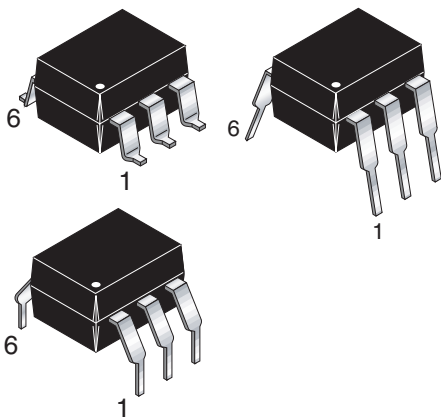

Parameter	Symbol	Device	Value	Units
TOTAL DEVICE				
Storage Temperature	T_{STG}	All	-55 to +150	°C
Operating Temperature	T_{OPR}	All	-55 to +100	°C
Lead Solder Temperature	T_{SOL}	All	260 for 10 sec	°C
Total Device Power Dissipation	P_D	All	350	mW
Derate Linearly From 25°C			4.6	mW/°C
EMITTER				
Continuous Forward Current	I_F	All	100	mA
Forward Current - Peak (1 μ s pulse, 300 pps)	$I_{F(pk)}$	All	± 1.0	A
LED Power Dissipation	P_D	All	200	mW
Derate Linearly From 25°C			2.6	mW/°C
DETECTOR				
Detector Power Dissipation	P_D	All	300	mW
Derate above 25°C			4.0	mW/°C

Electrical Characteristics ($T_A = 25^\circ\text{C}$ Unless otherwise specified.)

Individual Component Characteristics

Parameter	Test Conditions	Symbol	Device	Min	Typ	Max	Unit
EMITTER							
Input Forward Voltage	$I_F = \pm 10\text{ mA}$	V_F	All		1.2	1.5	V
Capacitance	$V_F = 0\text{ V}, f = 1.0\text{ MHz}$	C_J	All		80		pF
DETECTOR							
Breakdown Voltage Collector to Emitter	$I_C = 1.0\text{ mA}, I_F = 0$	BV_{CEO}	All	30			V
Collector to Base	$I_C = 100\text{ }\mu\text{A}, I_F = 0$	BV_{CBO}	All	70			V
Emitter to Base	$I_E = 100\text{ }\mu\text{A}, I_F = 0$	BV_{EBO}	All	5			V
Emitter to Collector	$I_E = 100\text{ }\mu\text{A}, I_F = 0$	BV_{ECO}	All	7			V
Leakage Current Collector to Emitter	$V_{CE} = 10\text{ V}, I_F = 0$	I_{CEO}	H11AA1,3,4 H11AA2			50 200	nA
Capacitance Collector to Emitter	$V_{CE} = 0, f = 1\text{ MHz}$	C_{CE}	All		10		pF
Collector to Base	$V_{CE} = 0, f = 1\text{ MHz}$	C_{CB}	All		80		pF
Emitter to Base	$V_{CE} = 0, f = 1\text{ MHz}$	C_{EB}	All		15		pF

Transfer Characteristics ($T_A = 25^\circ\text{C}$ Unless otherwise specified.)

Characteristics	Test Conditions	Symbol	Device	Min	Typ	Max	Units
Current Transfer Ratio, Collector to Emitter	$I_F = \pm 10\text{ mA}, V_{CE} = 10\text{ V}$	CTR_{CE}	H11AA4	100			%
			H11AA3	50			
			H11AA1	20			
			H11AA2	10			
Current Transfer Ratio, Symmetry	$I_F = \pm 10\text{ mA}, V_{CE} = 10\text{ V}$ (Figure.8)		All	.33		3.0	
Saturation Voltage Collector to Emitter	$I_F = \pm 10\text{ mA}, I_{CE} = 0.5\text{ mA}$	$V_{CE(SAT)}$	All			.40	V

Isolation Characteristics

Characteristic	Test Conditions	Symbol	Min	Typ	Max	Units
Package Capacitance input/output	$V_{I-O} = 0, f = 1\text{ MHz}$	C_{I-O}		0.7		pF
Isolation Voltage	$f = 60\text{ Hz}, t = 1\text{ min.}$	V_{ISO}	5300			VAC(RMS)
Isolation Resistance	$V_{I-O} = 500\text{ VDC}$	R_{ISO}	1011			Ω

Fig. 1 Input Voltage vs. Input Current

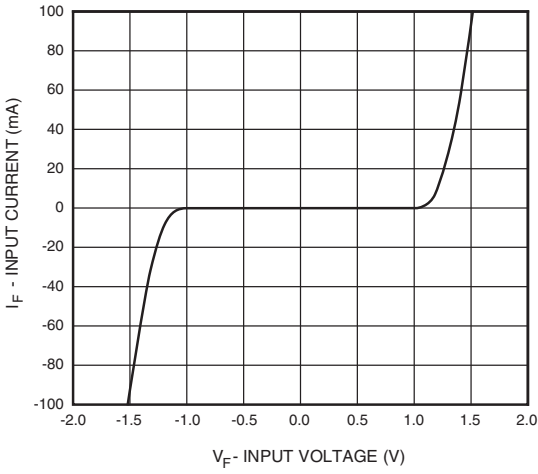

Fig. 2 Normalized CTR vs. Forward Current

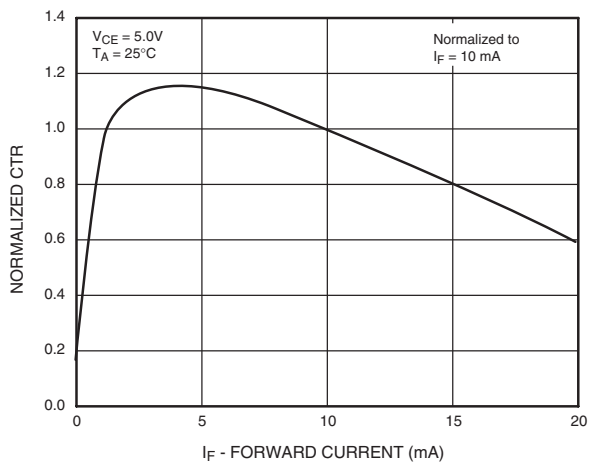

Fig. 3 Normalized CTR vs. Ambient Temperature

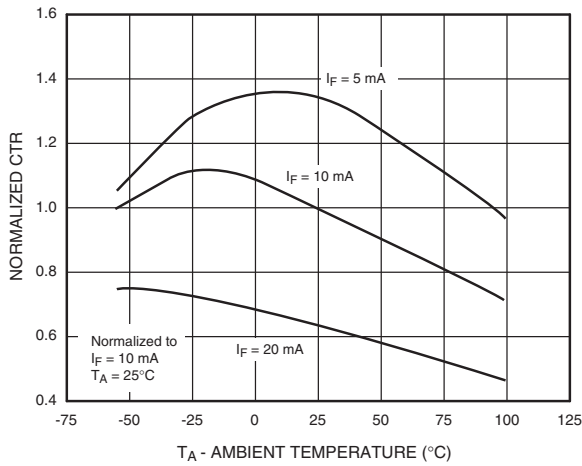

Fig. 4 CTR vs. RBE (Unsaturated)

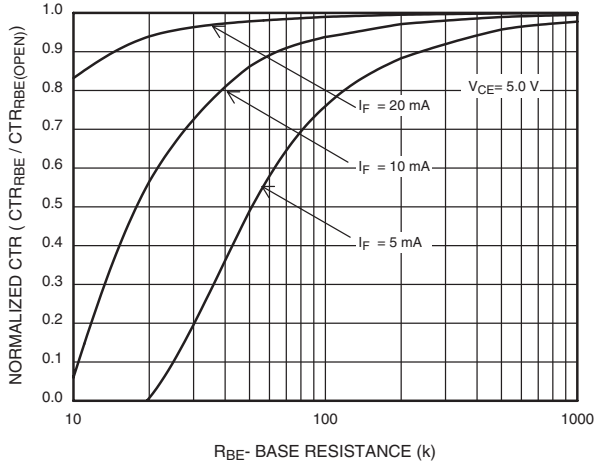

Fig. 5 CTR vs. RBE (Saturated)

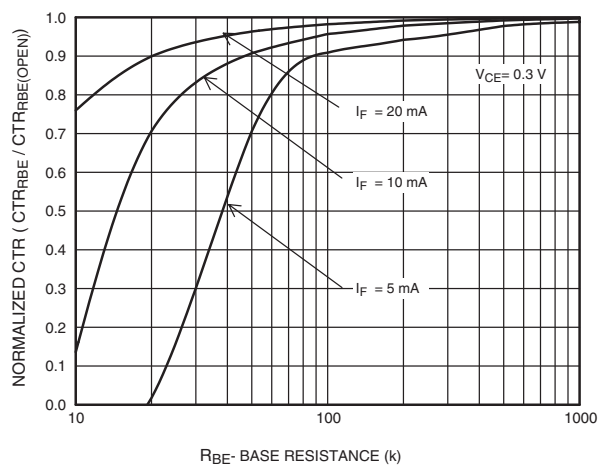

Fig. 6 Collector-Emitter Saturation Voltage vs. Collector Current

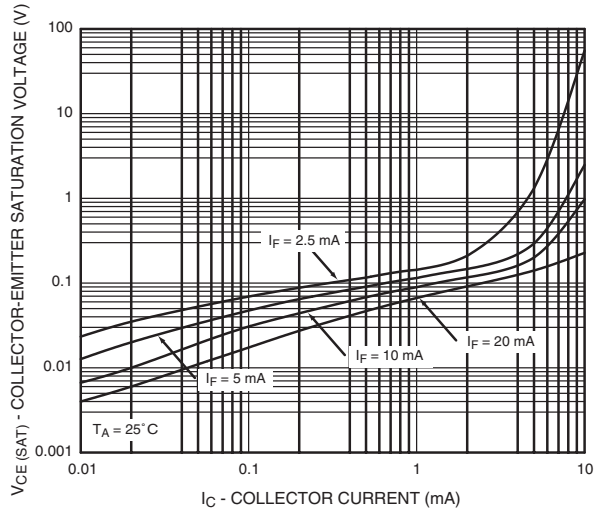

Fig. 7 Switching Speed vs. Load Resistor

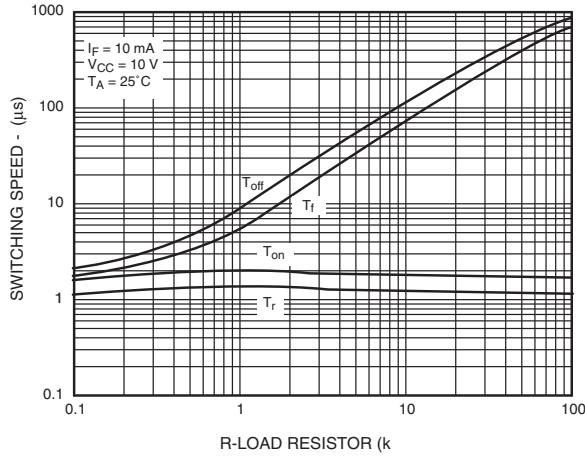

Fig. 8 Normalized t_{on} vs. R_{BE}

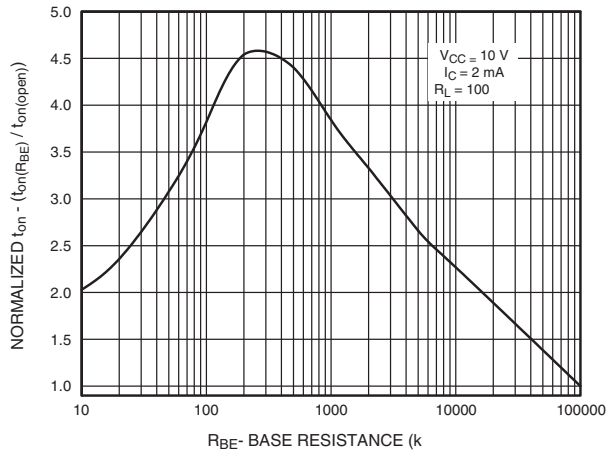

Fig. 9 Normalized t_{off} vs. R_{BE}

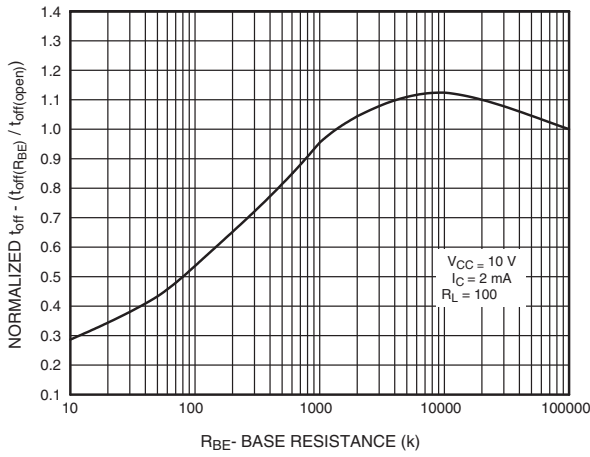

Fig. 10 Dark Current vs. Ambient Temperature

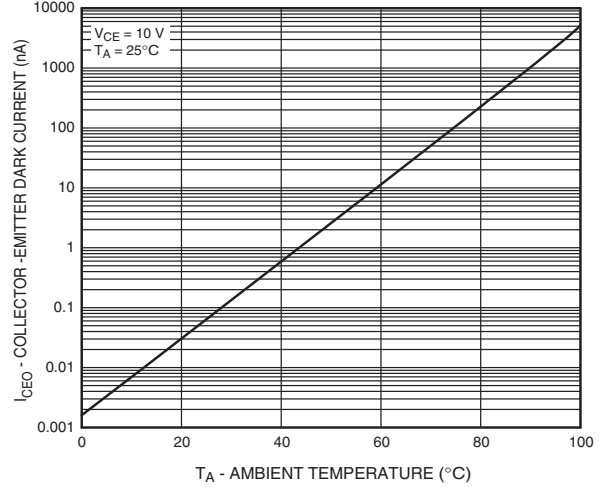
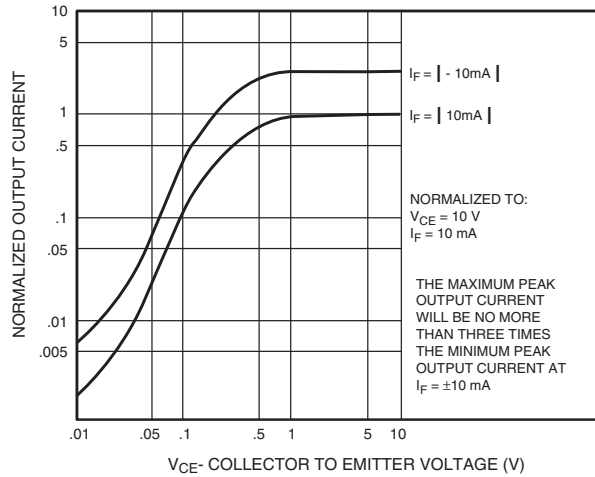

Fig. 11 Output Symmetry Characteristics



Ordering Information

Option	Order Entry Identifier	Description
S	.S	Surface Mount Lead Bend
SD	.SD	Surface Mount; Tape and Reel
W	.W	0.4" Lead Spacing
300	.300	VDE 0884
300W	.300W	VDE 0884, 0.4" Lead Spacing
3S	.3S	VDE 0884, Surface Mount
3SD	.3SD	VDE 0884, Surface Mount, Tape and Reel

Carrier Tape Specifications ("D" Taping Orientation)

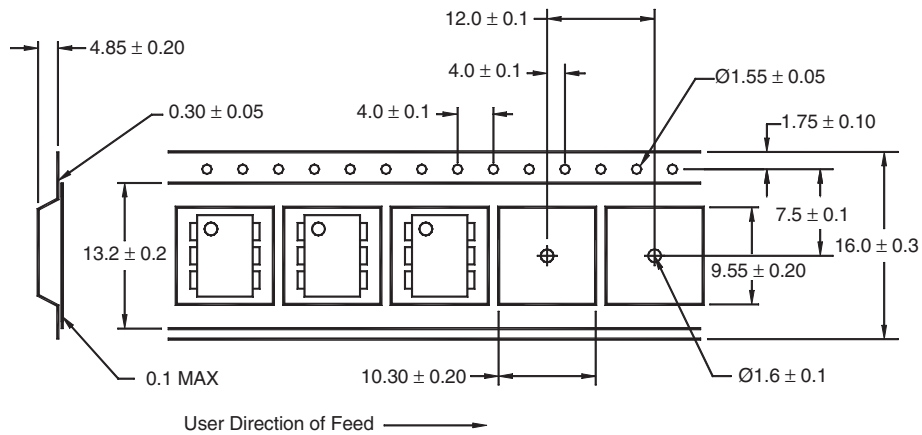

Note
All dimensions are in millimeters

Marking Information

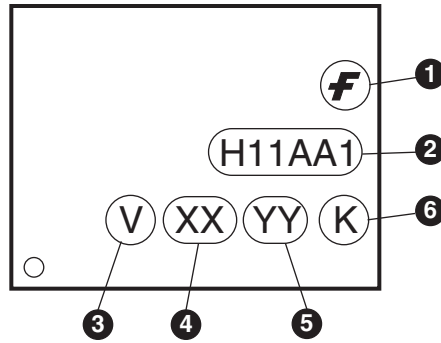

Definitions	
1	Fairchild logo
2	Device number
3	VDE mark (Note: Only appears on parts ordered with VDE option – See order entry table)
4	Two digit year code, e.g., '03'
5	Two digit work week ranging from '01' to '53'
6	Assembly package code

Reflow Profile (Black Package, No Suffix)

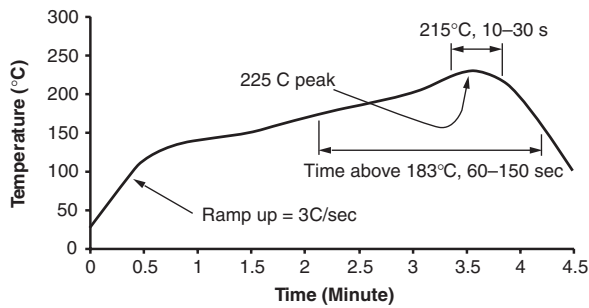

- Peak reflow temperature: 225°C (package surface temperature)
- Time of temperature higher than 183°C for 60–150 seconds
- One time soldering reflow is recommended

TRADEMARKS

The following are registered and unregistered trademarks Fairchild Semiconductor owns or is authorized to use and is not intended to be an exhaustive list of all such trademarks.

ACEx™	FAST®	ISOPLANAR™	PowerSaver™	SuperSOT™-8
ActiveArray™	FASTr™	LittleFET™	PowerTrench®	SyncFET™
Bottomless™	FPST™	MICROCOUPLER™	QFET®	TinyLogic®
Build it Now™	FRFET™	MicroFET™	QS™	TINYOPTO™
CoolFET™	GlobalOptoisolator™	MicroPak™	QT Optoelectronics™	TruTranslation™
CROSSVOLT™	GTO™	MICROWIRE™	Quiet Series™	UHC™
DOME™	HiSeC™	MSX™	RapidConfigure™	UltraFET®
EcoSPARK™	I ² C™	MSXPro™	RapidConnect™	UniFET™
E ² CMOST™	i-Lo™	OCX™	μSerDes™	VCX™
EnSigna™	ImpliedDisconnect™	OCXPro™	SILENT SWITCHER®	Wire™
FACT™	IntelliMAX™	OPTOLOGIC®	SMART START™	
FACT Quiet Series™		OPTOPLANAR™	SPM™	
Across the board. Around the world.™		PACMAN™	Stealth™	
The Power Franchise®		POP™	SuperFET™	
Programmable Active Droop™		Power247™	SuperSOT™-3	
		PowerEdge™	SuperSOT™-6	

DISCLAIMER

FAIRCHILD SEMICONDUCTOR RESERVES THE RIGHT TO MAKE CHANGES WITHOUT FURTHER NOTICE TO ANY PRODUCTS HEREIN TO IMPROVE RELIABILITY, FUNCTION OR DESIGN. FAIRCHILD DOES NOT ASSUME ANY LIABILITY ARISING OUT OF THE APPLICATION OR USE OF ANY PRODUCT OR CIRCUIT DESCRIBED HEREIN; NEITHER DOES IT CONVEY ANY LICENSE UNDER ITS PATENT RIGHTS, NOR THE RIGHTS OF OTHERS.

LIFE SUPPORT POLICY

FAIRCHILD'S PRODUCTS ARE NOT AUTHORIZED FOR USE AS CRITICAL COMPONENTS IN LIFE SUPPORT DEVICES OR SYSTEMS WITHOUT THE EXPRESS WRITTEN APPROVAL OF FAIRCHILD SEMICONDUCTOR CORPORATION. As used herein:

1. Life support devices or systems are devices or systems which, (a) are intended for surgical implant into the body, or (b) support or sustain life, or (c) whose failure to perform when properly used in accordance with instructions for use provided in the labeling, can be reasonably expected to result in significant injury to the user.
2. A critical component is any component of a life support device or system whose failure to perform can be reasonably expected to cause the failure of the life support device or system, or to affect its safety or effectiveness.

PRODUCT STATUS DEFINITIONS

Definition of Terms

Datasheet Identification	Product Status	Definition
Advance Information	Formative or In Design	This datasheet contains the design specifications for product development. Specifications may change in any manner without notice.
Preliminary	First Production	This datasheet contains preliminary data, and supplementary data will be published at a later date. Fairchild Semiconductor reserves the right to make changes at any time without notice in order to improve design.
No Identification Needed	Full Production	This datasheet contains final specifications. Fairchild Semiconductor reserves the right to make changes at any time without notice in order to improve design.
Obsolete	Not In Production	This datasheet contains specifications on a product that has been discontinued by Fairchild semiconductor. The datasheet is printed for reference information only.

Rev. I16