



SB1045L THRU SB10200L

Reverse Voltage - 45 to 200 Volts Forward Current -10.0 Ampere

SURFACE MOUNT SCHOTTKY BARRIER RECTIFIER

Features

- ◆ Schottky Barrier Chip
- ◆ High Thermal Reliability
- ◆ Patented Super Barrier Rectifier Technology
- ◆ High Forward Surge Capability
- ◆ Ultra Low Power Loss, High Efficiency
- ◆ Excellent High temperature Stability
- ◆ Plastic material-UL flammability 94V-0

TO-277

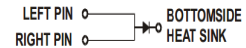
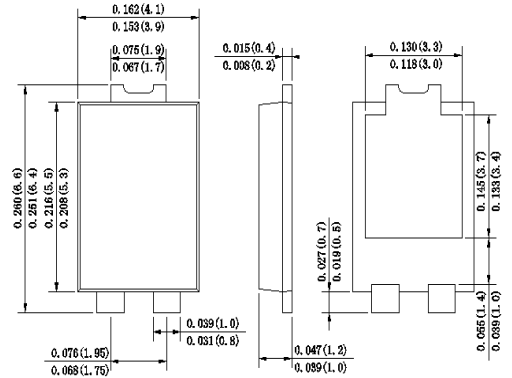

Dimensions in inches and (millimeters)

Mechanical Data

Case : JEDEC TO-277 Molded plastic body

Terminals :Plated Leads Solderable per MIL-STD-202,Method 208

Polarity : Polarity symbol marking on body

Mounting Position : Any

Weight : 0.003 ounce, 0.092 grams

Maximum Ratings And Electrical Characteristics

Ratings at 25°C ambient temperature unless otherwise specified.

Single phase half-wave 60Hz, resistive or inductive load, for capacitive load current derate by 20%.

Parameter	SYMBOLS	MDD	MDD	MDD	MDD	MDD	MDD	MDD	UNIT
		SB1045L	SB1050L	SB1060L	SB1080L	SB10100L	SB10150L	SB10200L	
Marking Code									
Maximum repetitive peak reverse voltage	V_{RRM}	45	50	60	80	100	150	200	V
Maximum working peak reverse voltage	V_{RWM}								
Maximum DC blocking voltage	V_{DC}								
RMS Reverse voltage	V_{RMS}	32	35	42	56	70	105	140	V
Average Rectified Output Current	$I_{(O)}$	10							A
Non-Repetitive Peak Forward Surge 8.3ms Single Half Sine-Wave Superimposed on rated load(JEDEC Method)	I_{FSM}	150							A
Forward Voltage Drop at 10.0A $T_A=25^\circ C$	V_F	0.55	0.70	0.85		0.90	0.92	V	
Peak reverse current at rated DC blocking voltage $T_A=25^\circ C$ $T_A=125^\circ C$	I_R	0.3 15							mA
Typical thermal resistance Junction to Ambient	$R_{\theta JA}$ $R_{\theta JL}$	80 15							$^\circ C/W$
Operating junction and storage temperature range	T_J, T_{STG}	-55 to +150							$^\circ C$

Note:1. Valid Provided that are kept at ambient temperature at a distance of 9.5mm from the case.

2. Fr-4pcb.2oz.Copper, minimum recommend pad layout .18.8mm×14.4.Anode pad dimensions 5.6mm×14.4mm.



SB1045L THRU SB10200L

Reverse Voltage - 45 to 200 Volts Forward Current -10.0 Ampere

Ratings And Characteristic Curves

Fig.1 - Forward Current Derating Curve

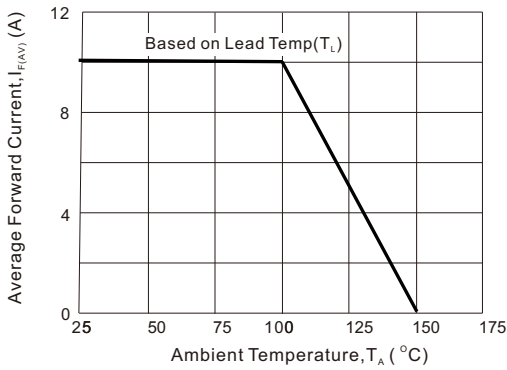

Fig2 : Instantaneous Forward Voltage

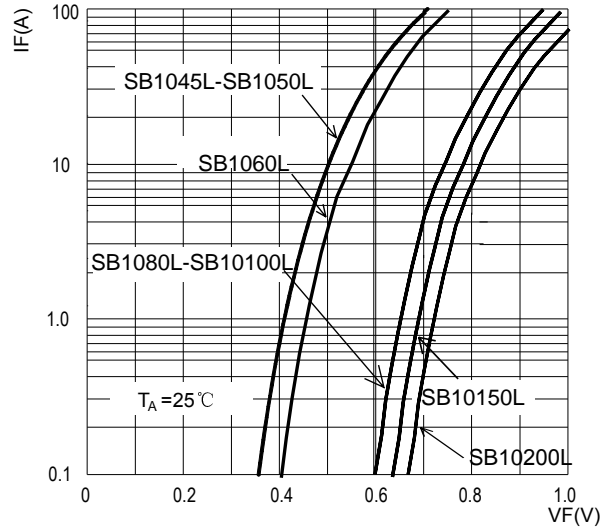

Fig3: Surge Forward Current Capacity

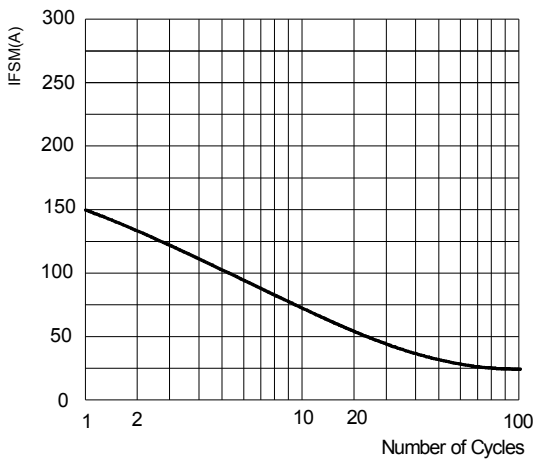
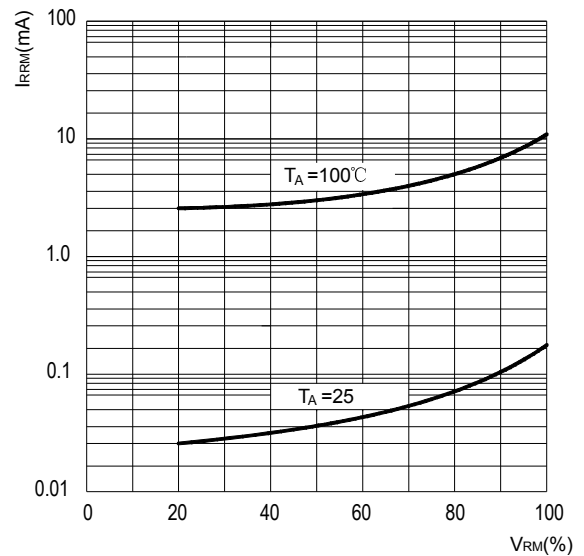

Fig4: Typical Reverse Characteristics



The curve above is for reference only.



SB1045L THRU SB10200L

Reverse Voltage - 45 to 200 Volts Forward Current -10.0 Ampere

Packing information

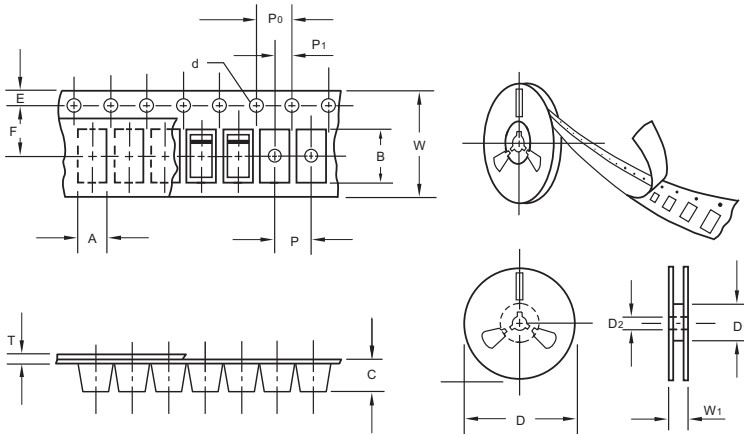

unit:mm

Item	Symbol	Tolerance	TO-277
Carrier width	A	0.1	4.45
Carrier length	B	0.1	7.0
Carrier depth	C	0.1	1.60
Sprocket hole	d	0.05	1.55
11" Reel outside diameter	D	2.0	280.00
11" Reel inner diameter	D1	min	50.0
Feed hole diameter	D2	0.5	13.00
Sprocket hole position	E	0.1	1.75
Punch hole position	F	0.1	7.50
Punch hole pitch	P	0.1	8.00
Sprocket hole pitch	P0	0.1	4.00
Embossment center	P1	0.1	2.00
Overall tape thickness	T	0.1	0.25
Tape width	W	0.3	12.00
Reel width	W1	1.0	12.30

Note: Devices are packed in accordance with EIA standard RS-481-A and specifications listed above.

Reel packing

PACKAGE	REEL SIZE	REEL (pcs)	COMPONENT SPACING (m/m)	BOX (pcs)	INNER BOX (m/m)	REEL DIA. (m/m)	CARTON SIZE (m/m)	CARTON (pcs)	APPROX. GROSS WEIGHT (kg)
TO-277	11"	3,000	5.0	6,000	340*340*43	280	380*380*380	48,000	9.0

Suggested Pad Layout

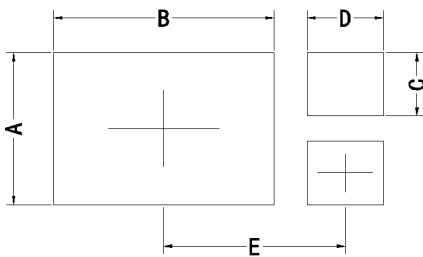

Symbol	Unit (mm)	Unit (inch)
A	3.60	0.142
B	5.35	0.211
C	1.50	0.059
D	1.85	0.073
E	4.30	0.169