



B0520W THRU B0540W

Reverse Voltage 20-40 Volts Forward Current - 0.5 Ampere

SCHOTTKY DIODES

Features

- ◆ Low forward voltage drop
- ◆ Guard ring construction for transient protection
- ◆ High conductance
- ◆ Also available in lead free version

SOD-123

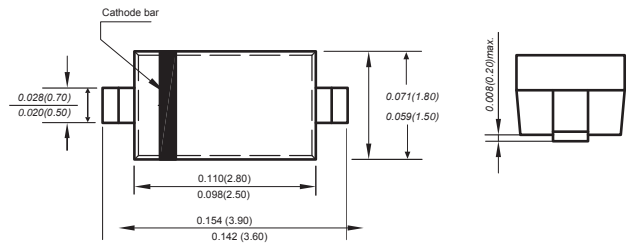

Mechanical Data

Case: JEDEC SOD-123 molded plastic body
 Terminals: Plated leads solderable per MIL-STD-750, Method 2026

Polarity: Polarity symbols marked on case

Weight: 0.00056 ounce, 0.016 grams

Marking: B0520W:SD, B0530W:SE, B0540W:SF

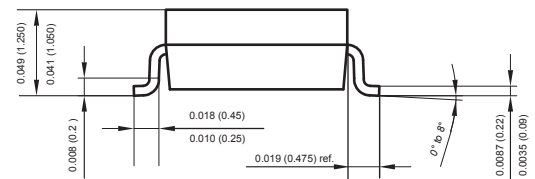

Dimensions in inches and (millimeters)

Absolute Maximum Ratings at 25 °C

Parameter	Symbols	B0520W	B0530W	B0540W	Units
Maximum Repetitive Peak Reverse Voltage	V_{RRM}	20	30	40	V
Maximum RMS voltage	V_{RMS}	14	21	28	V
Average rectified output current	I_0		0.5		A
Voltage rate of change	dv/dt		1000		v/us
Non-repetitive Peak Forward Surge Current at 8.3ms	I_{FSM}		25		A
Power dissipation	P_d		410		mW
Typical Thermal Resistance ⁽¹⁾	$R_{\theta JA}$		200		°C/W
Operating and Storage Temperature Range	T_j, T_{stg}		-55 ~ +150		°C

(1) P.C.B. mounted with 2.0" X 2.0" (5 X 5 cm) copper pad areas.

Characteristics at Ta= 25 °C

Parameter	Symbols	B0520W	B0530W	B0540W	Units
Reverse Breakdown Voltage at I_R at 250uA at 130uA at 20uA	$V_{(BR)R}$	20	30	40	V
Maximum Forward Voltage at I_F at 0.1A at 0.5A at 1A	V_F	0.330 0.390 —	0.375 0.430 —	— 0.510 0.620	V
Peak Reverse Current at VR at 10V at 15V at 20V at 30V at 40V	I_R	75 — 250 — —	— 20 — 130 —	— — 10 — 20	uA
Typical Junction Capacitance	C_j		170		pF
Reverse recovery time $I_F=I_R=10mA, I_{rr}=0.1X I_R, R_L=100\Omega$	trr			4	ns



B0520W THRU B0540W

Reverse Voltage 20-40 Volts Forward Current - 0.5 Ampere

Typical Characteristics

Fig.1 Forward Current Derating Curve

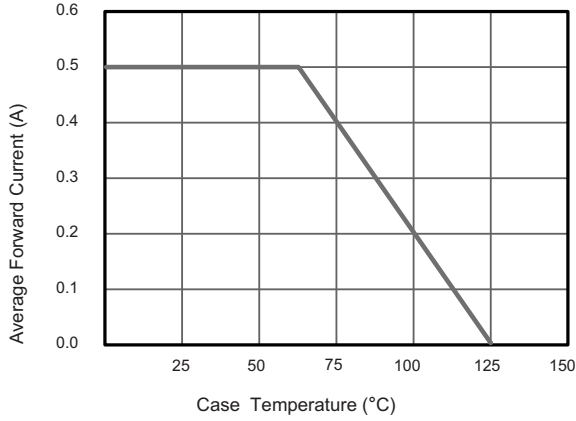

Fig.2 Typical Reverse Characteristics

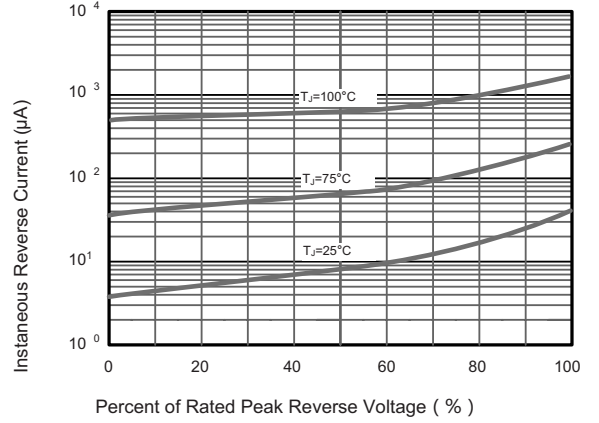

Fig.3 TYPICAL FORWARD VOLTAGE

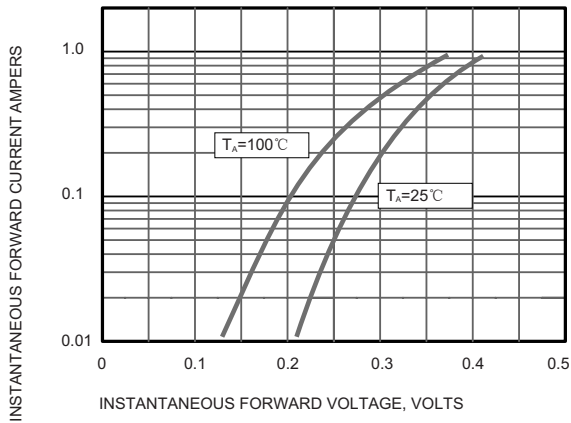

Fig.4 Typical Junction Capacitance

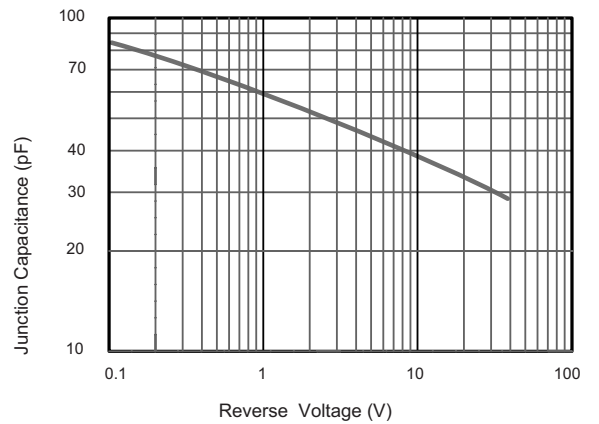

Fig.5 Maximum Non-Repetitive Peak Forward Surge Current

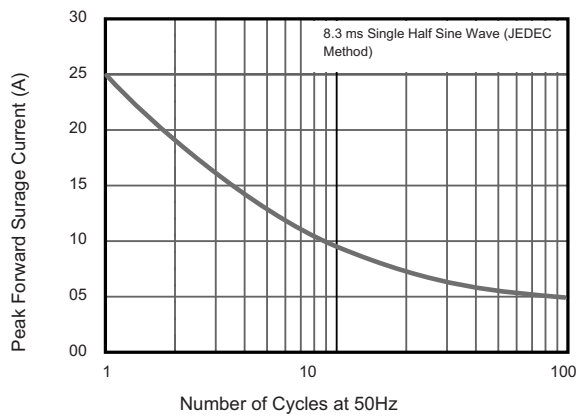
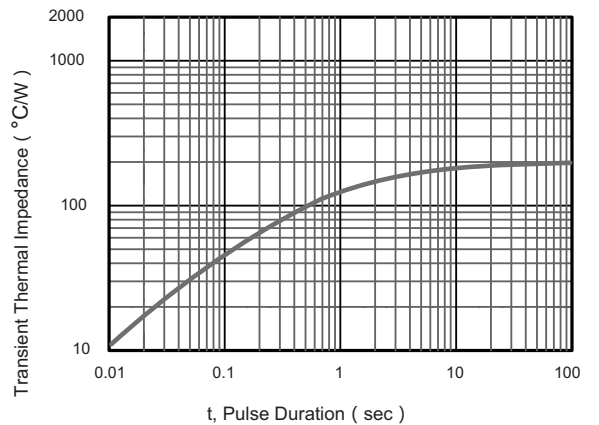

Fig.6 Typical Transient Thermal Impedance



The curve above is for reference only.



B0520W THRU B0540W

Reverse Voltage 20-40 Volts Forward Current - 0.5 Ampere

Packing information

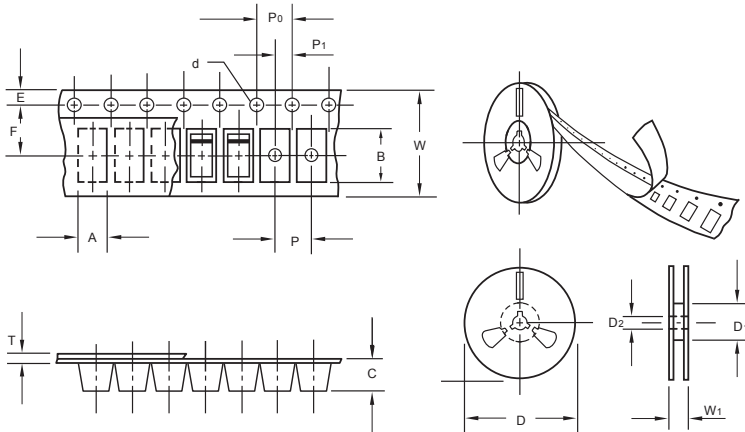

unit:mm

Item	Symbol	Tolerance	SOD-123
Carrier width	A	0.1	2.1
Carrier length	B	0.1	4.0
Carrier depth	C	0.1	1.60
Sprocket hole	d	0.05	1.55
7" Reel outside diameter	D	2.0	178.00
7" Reel inner diameter	D ₁	min	50.0
Feed hole diameter	D ₂	0.5	13.00
Sprocket hole position	E	0.1	1.75
Punch hole position	F	0.1	3.50
Punch hole pitch	P	0.1	4.00
Sprocket hole pitch	P ₀	0.1	4.00
Embossment center	P ₁	0.1	2.00
Overall tape thickness	T	0.1	0.25
Tape width	W	0.3	8.15
Reel width	W ₁	1.0	10.5

Note: Devices are packed in accordance with EIA standard RS-481-A and specifications listed above.

Reel packing

PACKAGE	REEL SIZE	REEL (pcs)	COMPONENT SPACING (m/m)	BOX (pcs)	INNER BOX (m/m)	REEL DIA, (m/m)	CARTON SIZE (m/m)	CARTON (pcs)	APPROX. GROSS WEIGHT (kg)
SOD-123	7"	3,000	4.0	45,000	210*208*203	178	430*430*235	180,000	9.0

Suggested Pad Layout

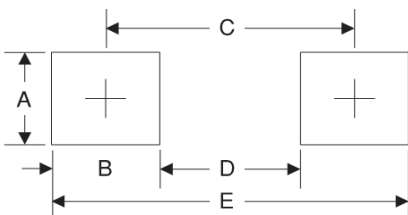

Symbol	Unit (mm)	Unit (inch)
A	1.2	0.047
B	1.2	0.047
C	3.2	0.126
D	2.0	0.079
E	4.4	0.173