

注: 本板为禁止传输、复制、编辑文件, 以及用其内容建库依据

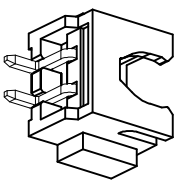
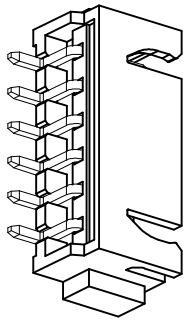
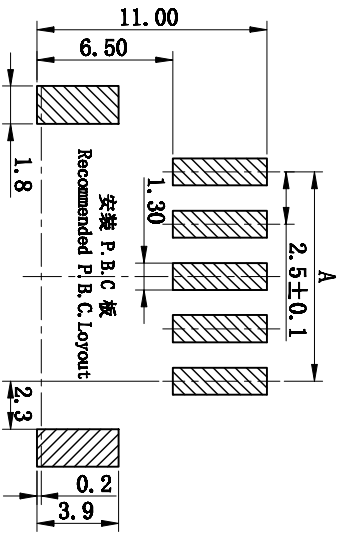
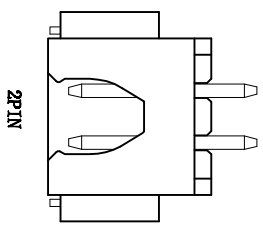
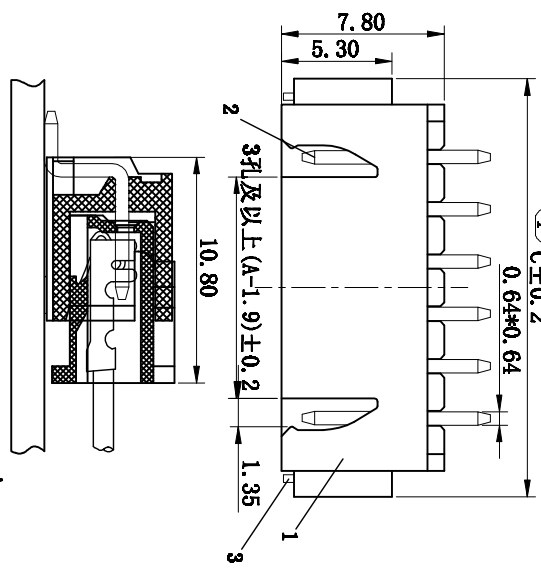
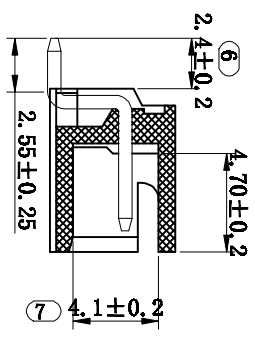
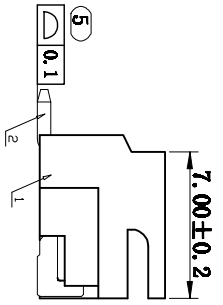
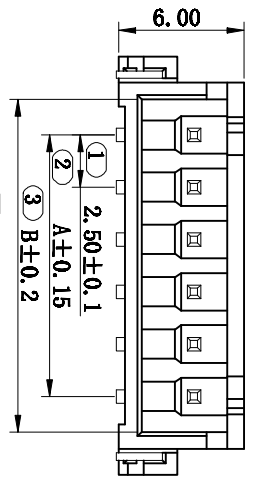

- 技术指标:
- 1、塑件表面应光洁、无毛刺、明显收缩、缺陷、裂纹等现象;
 - 2、温度范围: -25°C~+85°C;
 - 3、额定电压: 250V, AC, DC(等效);
 - 4、额定电流: 3A(24H);
 - 5、接触电阻: $\leq 0.03\Omega$;
 - 6、绝缘电阻: $\geq 1000M\Omega$;
 - 7、耐压: 1000V, AC/minute.

| REV | ECN NO. | CONTENT | CHK | DATE | |
|-----|---------|----------|------|------|------|
| | | 孔位 poles | A | B | C |
| | | 2 | 2.5 | 5.9 | 10.0 |
| | | 3 | 5.0 | 8.4 | 12.5 |
| | | 4 | 7.5 | 10.9 | 15.0 |
| | | 5 | 10.0 | 13.4 | 17.5 |
| | | 6 | 12.5 | 15.9 | 20.0 |
| | | 7 | 15.0 | 18.4 | 22.5 |
| | | 8 | 17.5 | 20.9 | 25.0 |
| | | 9 | 20.0 | 23.4 | 27.5 |
| | | 10 | 22.5 | 25.9 | 30.0 |
| | | 11 | 25.0 | 28.4 | 32.5 |
| | | 12 | 27.5 | 30.9 | 35.0 |
| | | 13 | 30.0 | 33.4 | 37.5 |
| | | 14 | 32.5 | 35.9 | 40.0 |
| | | 15 | 35.0 | 38.4 | 42.5 |
| | | 16 | 37.5 | 40.9 | 45.0 |

- ROHS 豁免规定:
- 1、禁止使用含有 ROHS 指令所限制的物质。
 - 2、对应的 SSSMITS 出具的 ICP-MS 数据。
 - 3、不可测定物质豁免分类, 有效期一年。

How to order

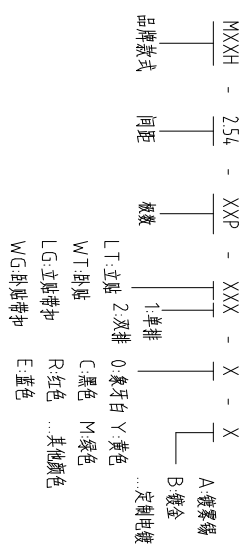

GENERAL TOLERANCES

| | | |
|-------|-------|------------|
| 0.X | ±0.25 | X' ±3° |
| 0.XX | ±0.12 | |
| 0.XXX | ±0.05 | X.X' ±0.5° |

| | | | | | |
|---|-----------|---------------|-----|---|-----------|
| 3 | 拼 fitting | 精 | | 精 | 80U "MIN. |
| 2 | 轻 Contact | 精 | n*1 | | 80U "MIN. |
| 1 | 基 Wafer | LCP (UL94V-0) | 1 | | 80U "MIN. |

| ITEM | NAME OF PART | NO. OF PART | Q'TY | MATERIAL | NOTE |
|------|--------------|-------------|----------|------------------|------|
| DWG | CHK | DATE | 23.08.10 | | |
| CHK | DATE | | | | |
| APP | DATE | | | | |
| | NAME | | | MXXH-254-XXP-WT1 | |

CIXI MAXXU ELECTRONICS CO.,LTD
 慈溪市迈旭电子有限公司