

## FEATURES

- Fast switching
- 100% avalanche tested
- Improved dv/dt capability

## APPLICATIONS

- Switch Mode Power Supply (SMPS)
- Uninterruptible Power Supply (UPS)
- Power Factor Correction (PFC)

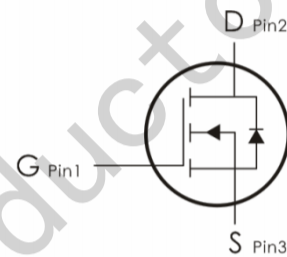
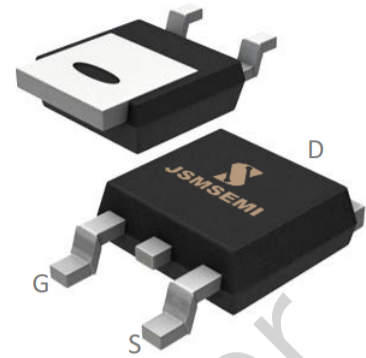

### Device Marking and Package Information

Device	Package	Marking
FQD12N20TM	TO-252	FQD12N20

### Absolute Maximum Ratings $T_C = 25^\circ\text{C}$ , unless otherwise noted

Parameter	Symbol	Value	Unit
		TO-252	
Drain-Source Voltage ( $V_{GS} = 0V$ )	$V_{DSS}$	200	V
Continuous Drain Current	$I_D$	9	A
Pulsed Drain Current (note1)	$I_{DM}$	36	A
Gate-Source Voltage	$V_{GSS}$	$\pm 20$	V
Single Pulse Avalanche Energy (note2)	$E_{AS}$	115	mJ
Avalanche Current (note1)	$I_{AS}$	5	A
Repetitive Avalanche Energy (note1)	$E_{AR}$	69	mJ
Power Dissipation ( $T_C = 25^\circ\text{C}$ )	$P_D$	74	W
Operating Junction and Storage Temperature Range	$T_J, T_{stg}$	-55~+150	$^\circ\text{C}$

### Thermal Resistance

Parameter	Symbol	Value	Unit
		TO-252	
Thermal Resistance, Junction-to-Case	$R_{thJC}$	1.7	K/W
Thermal Resistance, Junction-to-Ambient	$R_{thJA}$	60	

Specifications $T_J = 25^\circ\text{C}$ , unless otherwise noted						
Parameter	Symbol	Test Conditions	Value			Unit
			Min.	Typ.	Max.	
<b>Static</b>						
Drain-Source Breakdown Voltage	$V_{(BR)DSS}$	$V_{GS} = 0V, I_D = 250\mu\text{A}$	200	--	--	V
Zero Gate Voltage Drain Current	$I_{DSS}$	$V_{DS} = 200V, V_{GS} = 0V, T_J = 25^\circ\text{C}$	--	--	1	$\mu\text{A}$
Gate-Source Leakage	$I_{GSS}$	$V_{GS} = \pm 20V$	--	--	$\pm 100$	nA
Gate-Source Threshold Voltage	$V_{GS(th)}$	$V_{DS} = V_{GS}, I_{DS} = 250\mu\text{A}$	2.0	--	4.0	V
Drain-Source On-Resistance (Note3)	$R_{DS(on)}$	$V_{GS} = 10V, I_D = 4.5A$	--	0.25	0.3	$\Omega$
<b>Dynamic</b>						
Input Capacitance	$C_{iss}$	$V_{GS} = 0V,$ $V_{DS} = 25V,$ $f = 1.0\text{MHz}$	--	605	--	pF
Output Capacitance	$C_{oss}$		--	87	--	
Reverse Transfer Capacitance	$C_{rss}$		--	37	--	
Total Gate Charge	$Q_g$	$V_{DD} = 160V, I_D = 9A,$ $V_{GS} = 10V$	--	19	--	nC
Gate-Source Charge	$Q_{gs}$		--	3	--	
Gate-Drain Charge	$Q_{gd}$		--	8	--	
Turn-on Delay Time	$t_{d(on)}$	$V_{DD} = 100V, I_D = 9A,$ $R_G = 25\Omega$	--	35	--	ns
Turn-on Rise Time	$t_r$		--	7	--	
Turn-off Delay Time	$t_{d(off)}$		--	98	--	
Turn-off Fall Time	$t_f$		--	32	--	
<b>Drain-Source Body Diode Characteristics</b>						
Continuous Body Diode Current	$I_S$	$T_C = 25^\circ\text{C}$	--	--	9	A
Pulsed Diode Forward Current	$I_{SM}$		--	--	36	
Body Diode Voltage	$V_{SD}$	$T_J = 25^\circ\text{C}, I_{SD} = 4.5A, V_{GS} = 0V$	--	--	1.4	V
Reverse Recovery Time	$t_{rr}$	$V_{GS} = 0V, I_S = 9A,$ $di_F/dt = 100A/\mu\text{s}$	--	145	--	ns
Reverse Recovery Charge	$Q_{rr}$		--	0.82	--	$\mu\text{C}$

**Notes**

1. Repetitive Rating: Pulse width limited by maximum junction temperature
2.  $L = 10\text{mH}, V_{DD} = 50V, R_G = 25\Omega$ , Starting  $T_J = 25^\circ\text{C}$
3. Pulse Test: Pulse width  $\leq 300\mu\text{s}$ , Duty Cycle  $\leq 1\%$

Typical Characteristics  $T_J = 25^\circ\text{C}$ , unless otherwise noted

Figure 1. Output Characteristics ( $T_J = 25^\circ\text{C}$ )

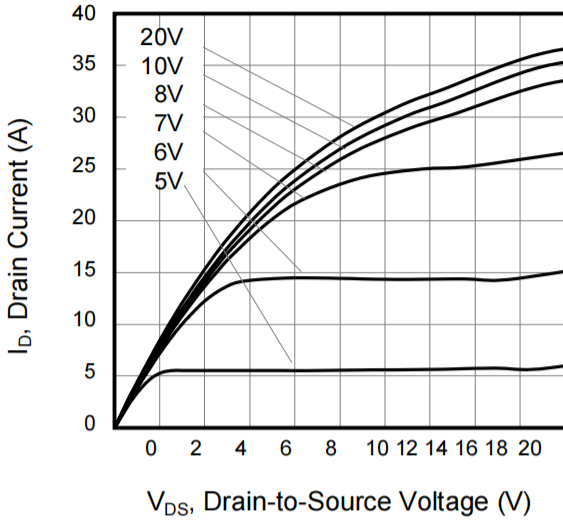

Figure 2. Body Diode Forward Voltage

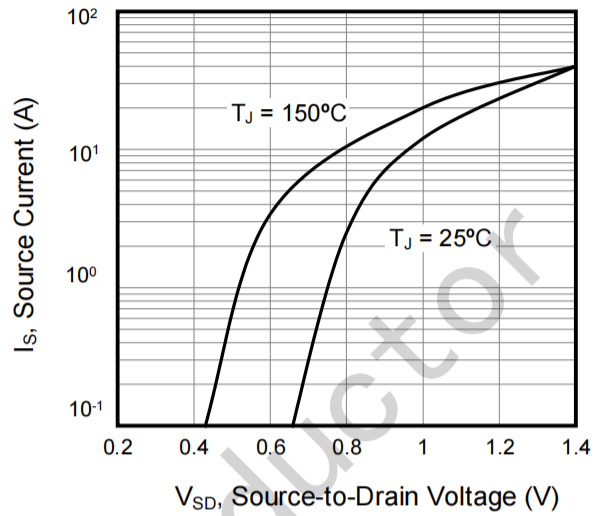

Figure 3. Drain Current vs. Temperature

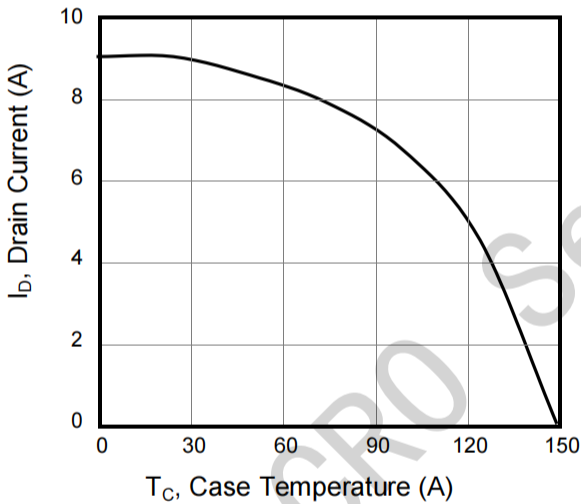

Figure 4.  $BV_{DSS}$  Variation vs. Temperature

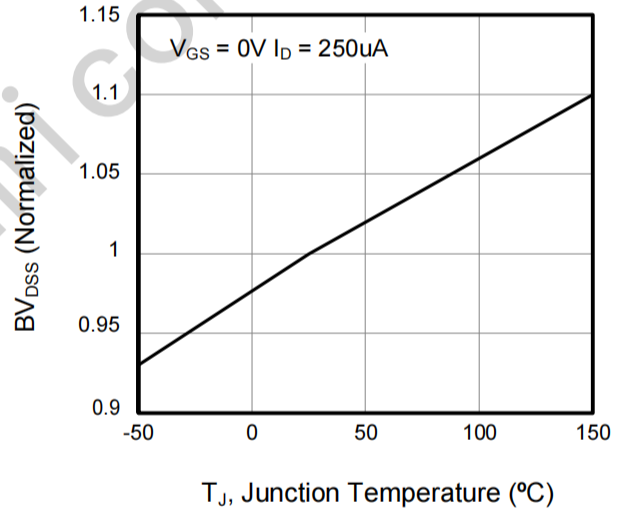

Figure 5. Transfer Characteristics

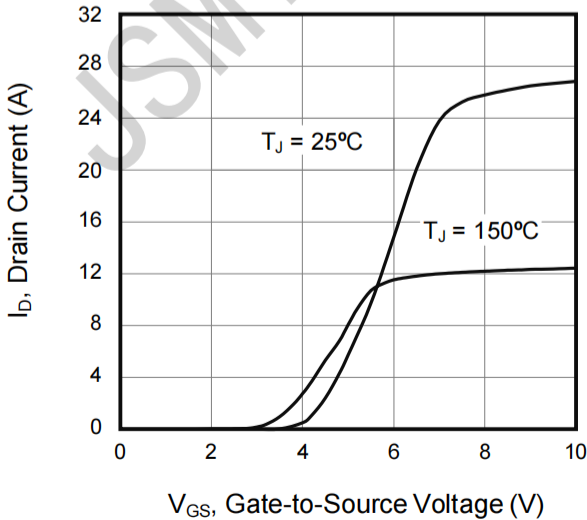
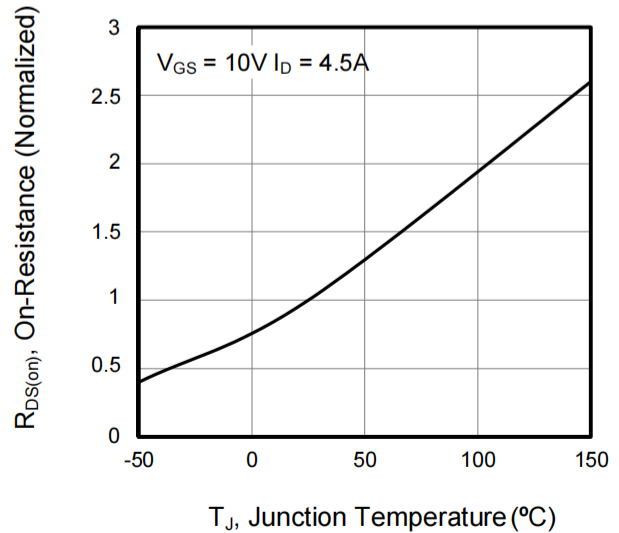
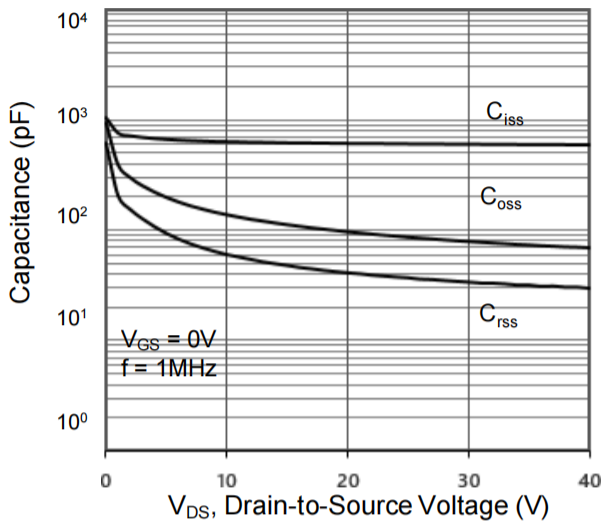

Figure 6. On-Resistance vs. Temperature



**Figure 7. Capacitance**



**Figure 8. Gate Charge**

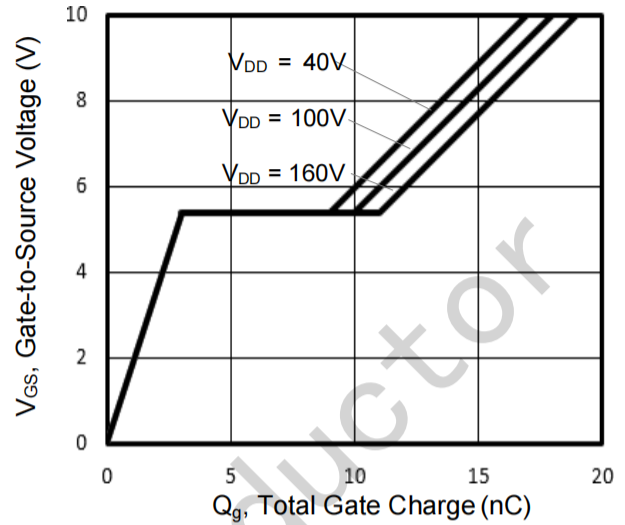

**Figure 9. Transient Thermal Impedance**

TO-252

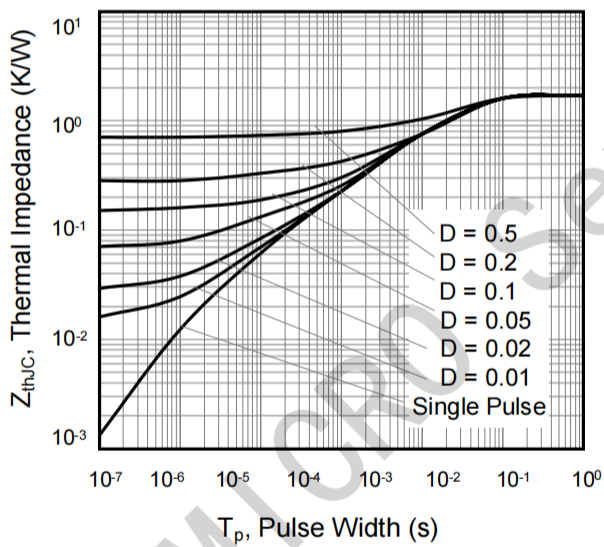

Figure A: Gate Charge Test Circuit and Waveform

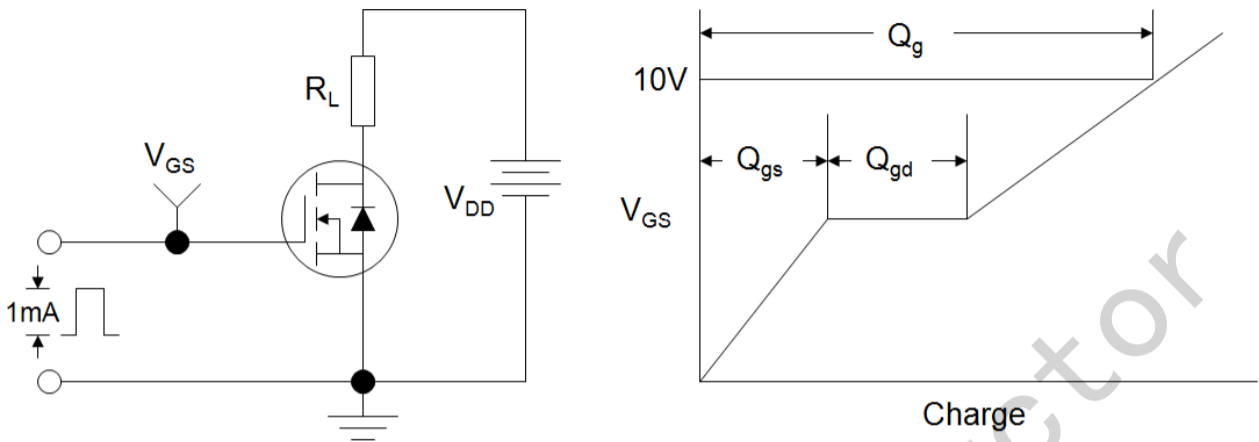

Figure B: Resistive Switching Test Circuit and Waveform

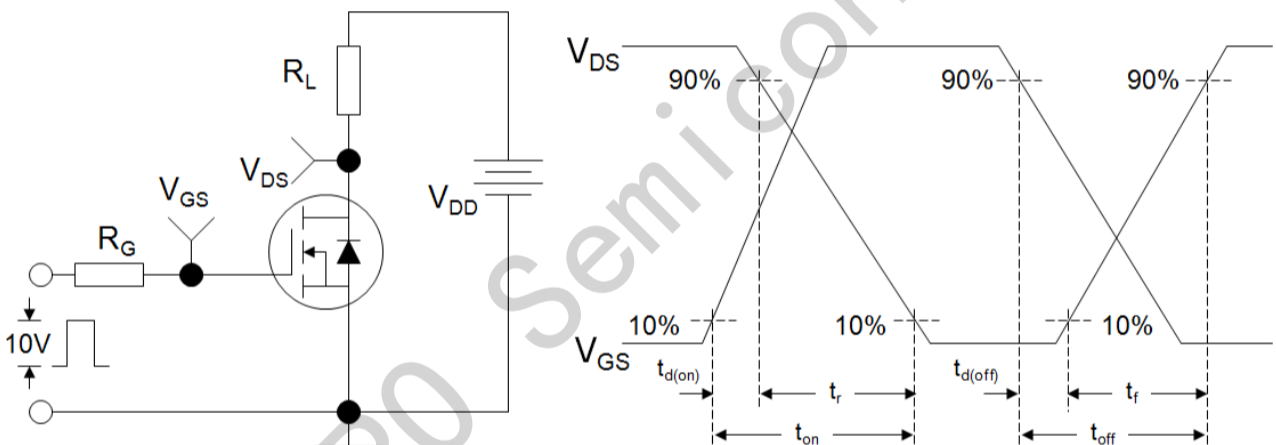
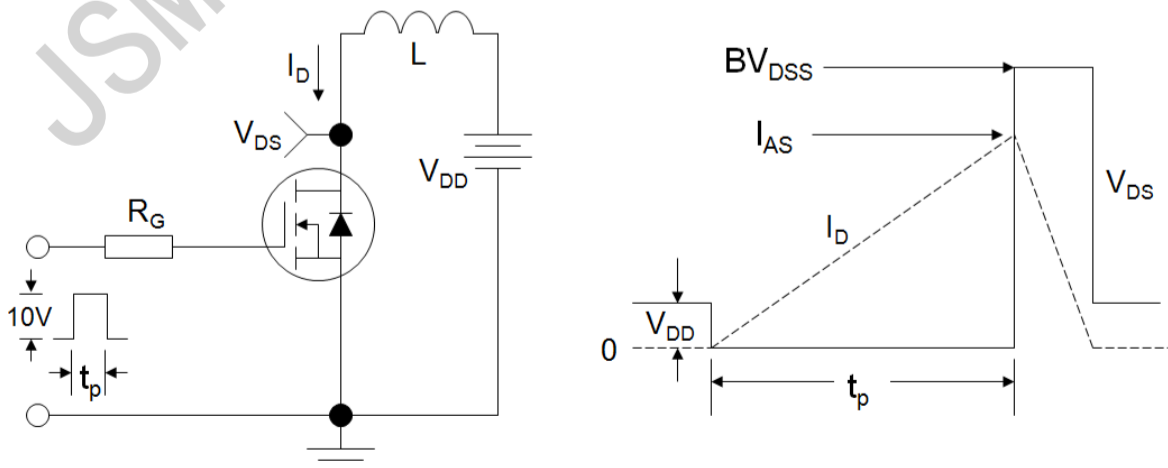
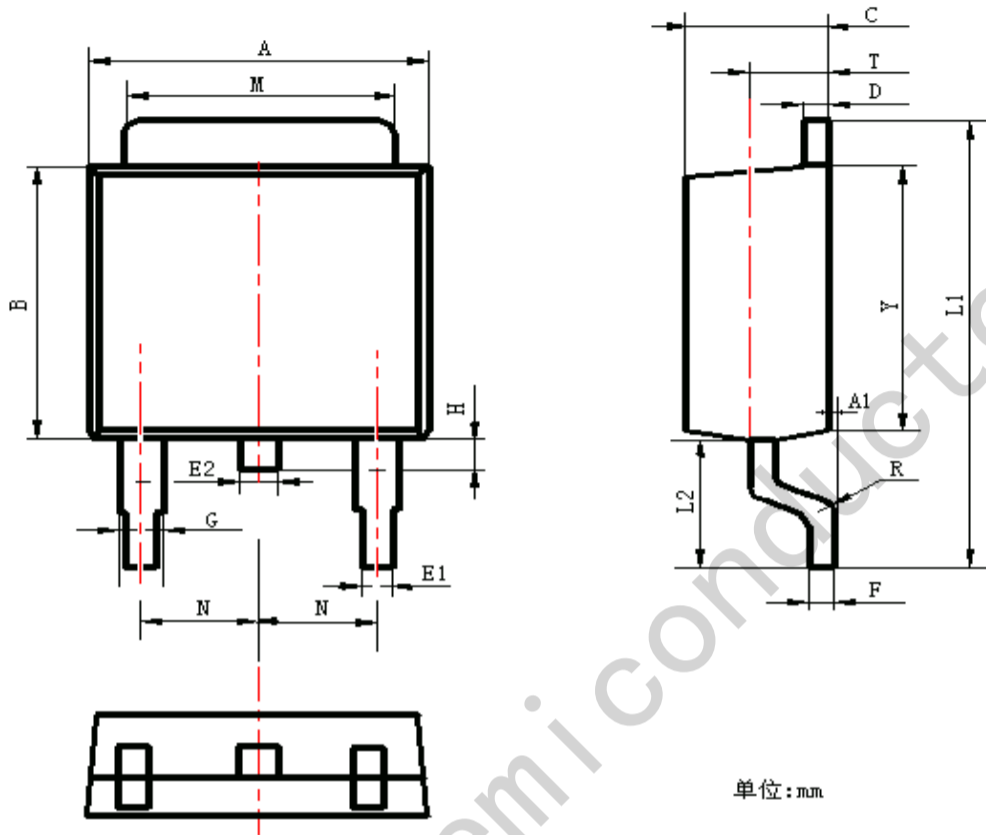

Figure C: Unclamped Inductive Switching Test Circuit and Waveform



TO-252 Package Information



单位: mm

Symbol	Dimensions In Millimeters		Dimensions In Inches	
	Min.	Max.	Min.	Max.
A	6.30	6.90	0.248	0.272
A1	0.00	0.16	0.000	0.006
B	5.70	6.30	0.224	0.248
C	2.10	2.50	0.083	0.098
D	0.30	0.70	0.012	0.028
E1	0.60	0.90	0.024	0.035
E2	0.70	1.00	0.028	0.039
F	0.30	0.60	0.012	0.024
G	0.70	1.20	0.028	0.047
L1	9.60	10.50	0.378	0.413
L2	2.70	3.10	0.106	0.122
H	0.40	1.00	0.016	0.039
M	5.10	5.50	0.201	0.217
N	2.09	2.49	0.082	0.098
R	0.30		0.012	
T	1.40	1.60	0.055	0.063
Y	5.10	6.30	0.201	0.248