

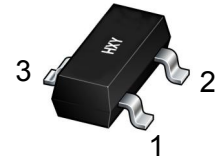

FEATURES

- Planar Die Construction.
- 300mW Power Dissipation.
- Zener Voltages from 2.4V - 43V.
- Ultra-Small Surface Mount Package Power Dissipation



SOT-23

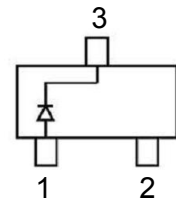

Package Marking and Ordering Information

Product ID	Pack	Marking	Qty(PCS)
BZX84C2V4- BZX84C43	SOT-23	XXX	3000

XXX=Device code, see table on page2 the marking code.

Absolute Maximum Ratings(Ta=25°C)

Symbol	Parameter	Value	Unit
V _F	Forward Voltage (Note 2) @ I _F =10mA	0.9	V
P _d	Power Dissipation (Note 1)	200	mW
R _{θJA}	Thermal Resistance From Junction To Ambient	625	°C/W
T _J	Operation Junction Temperature Range	-40~+125	°C
T _{STG}	Storage Temperature Range	-55~+150	°C



Electrical Characteristics (T a =25 °C unless otherwise specified)

Type Number	Code	Zener Voltage Range (Note 2)				Maximum Zener Impedance (Note 3)			Maximum Reverse Current		Temperature Coefficient of Zener voltage @ I _{ZT} =5mA mV/°C	
		V _Z @I _{ZT}			I _{ZT}	Z _{ZT} @I _{ZT}	Z _{ZK} @I _{ZK}	I _{ZK}	I _R	V _R	Min	Max
		Nom(V)	Min(V)	Max(V)	(mA)	(Ω)		(mA)	(μA)	(V)		
BZX84C2V4	Z11	2.4	2.20	2.60	5	100	600	1.0	50	1.0	-3.5	0
BZX84C2V7	Z12	2.7	2.5	2.9	5	100	600	1.0	20	1.0	-3.5	0
BZX84C3V0	Z13	3.0	2.8	3.2	5	95	600	1.0	10	1.0	-3.5	0
BZX84C3V3	Z14	3.3	3.1	3.5	5	95	600	1.0	5	1.0	-3.5	0
BZX84C3V6	Z15	3.6	3.4	3.8	5	90	600	1.0	5	1.0	-3.5	0
BZX84C3V9	Z16	3.9	3.7	4.1	5	90	600	1.0	3	1.0	-3.5	0
BZX84C4V3	Z17	4.3	4.0	4.6	5	90	600	1.0	3	1.0	-3.5	0
BZX84C4V7	Z1	4.7	4.4	5.0	5	80	500	1.0	3	2.0	-3.5	0.2
BZX84C5V1	Z2	5.1	4.8	5.4	5	60	480	1.0	2	2.0	-2.7	1.2
BZX84C5V6	Z3	5.6	5.2	6.0	5	40	400	1.0	1	2.0	-2.0	2.5
BZX84C6V2	Z4	6.2	5.8	6.6	5	10	150	1.0	3	4.0	0.4	3.7
BZX84C6V8	Z5	6.8	6.4	7.2	5	15	80	1.0	2	4.0	1.2	4.5
BZX84C7V5	Z6	7.5	7.0	7.9	5	15	80	1.0	1	5.0	2.5	5.3
BZX84C8V2	Z7	8.2	7.7	8.7	5	15	80	1.0	0.7	5.0	3.2	6.2
BZX84C9V1	Z8	9.1	8.5	9.6	5	15	100	1.0	0.5	6.0	3.8	7.0
BZX84C10	Z9	10	9.4	10.6	5	20	150	1.0	0.2	7.0	4.5	8.0
BZX84C11	Y1	11	10.4	11.6	5	20	150	1.0	0.1	8.0	5.4	9.0
BZX84C12	Y2	12	11.4	12.7	5	25	150	1.0	0.1	8.0	6.0	10.0
BZX84C13	Y3	13	12.4	14.1	5	30	170	1.0	0.1	8.0	7.0	11.0
BZX84C15	Y4	15	13.8	15.6	5	30	200	1.0	0.1	10.5	9.2	13.0
BZX84C16	Y5	16	15.3	17.1	5	40	200	1.0	0.1	11.2	10.4	14.0
BZX84C18	Y6	18	16.8	19.1	5	45	225	1.0	0.1	12.6	12.4	16.0
BZX84C20	Y7	20	18.8	21.2	5	55	225	1.0	0.1	14.0	14.4	18.0
BZX84C22	Y8	22	20.8	23.3	5	55	250	1.0	0.1	15.4	16.4	20.0
BZX84C24	Y9	24	22.8	25.6	5	70	250	1.0	0.1	16.8	18.4	22.0
BZX84C27	Y10	27	25.1	28.9	2	80	300	0.5	0.1	18.9	21.4	25.3
BZX84C30	Y11	30	28.0	32.0	2	80	300	0.5	0.1	21.0	24.4	29.4
BZX84C33	Y12	33	31.0	35.0	2	80	325	0.5	0.1	23.1	27.4	33.4
BZX84C36	Y13	36	34.0	38.0	2	90	350	0.5	0.1	25.2	30.4	37.4
BZX84C39	Y14	39	37.0	41.0	2	130	350	0.5	0.1	27.3	33.4	41.2
BZX84C43	Y15	43	40.0	46.0	2	100	700	1	0.1	32	10	12

- Notes: 1. Valid provided that device terminals are kept at ambient temperature.
2. Tested with pulses, period=5ms,pulse width =300μs.
3. f = 1kHz.



Typical Characteristics

Zener Characteristics (V_z Up to 10 V)

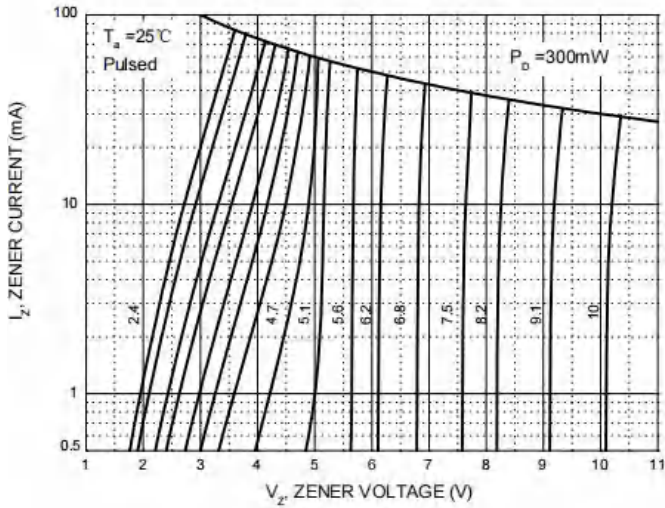

Zener Characteristics (11 V to 43 V)

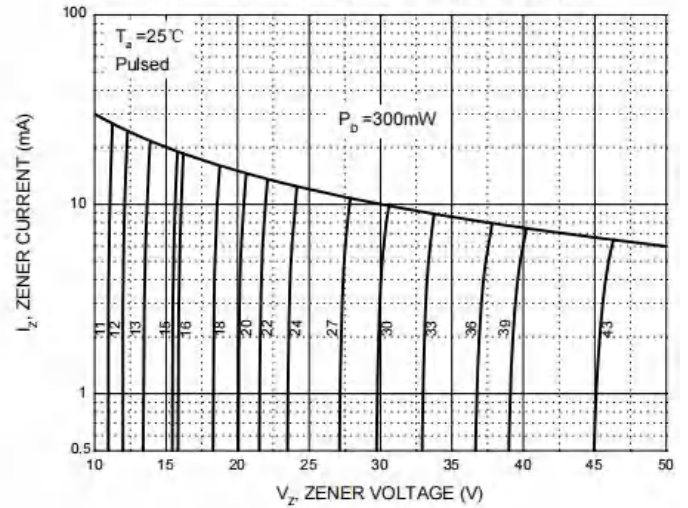

Temperature Coefficients

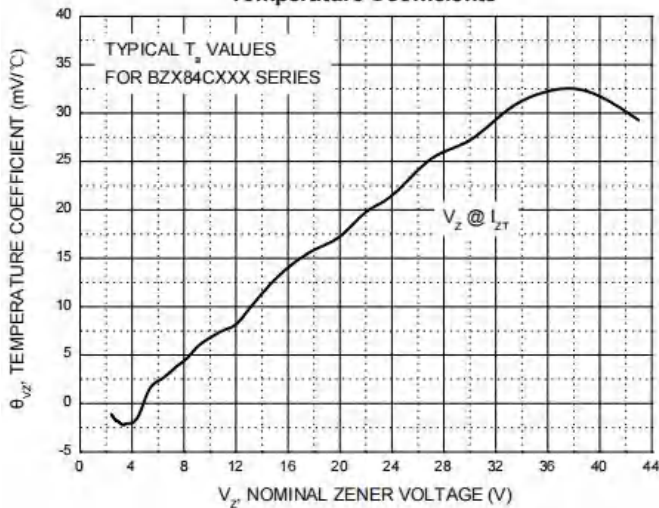

Typical Leakage Current

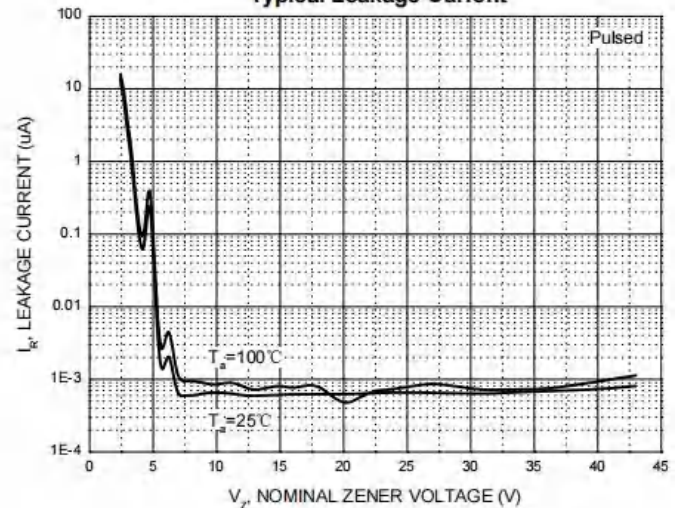



Typical Capacitance

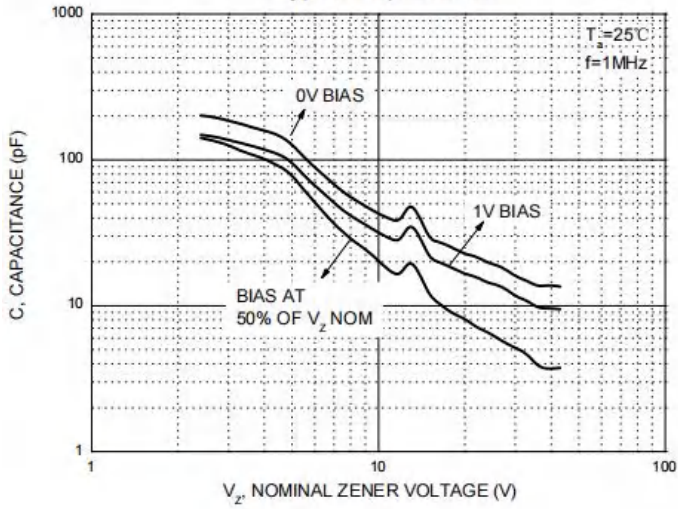

Effect of Zener Voltage on Zener Impedance

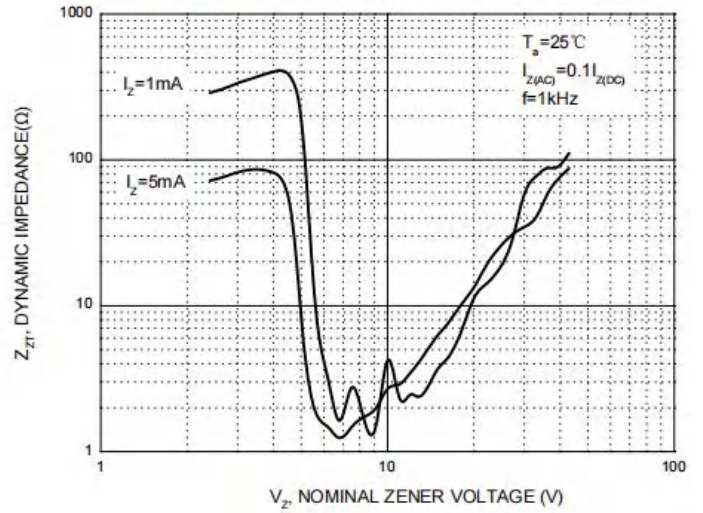

Power Derating Curve

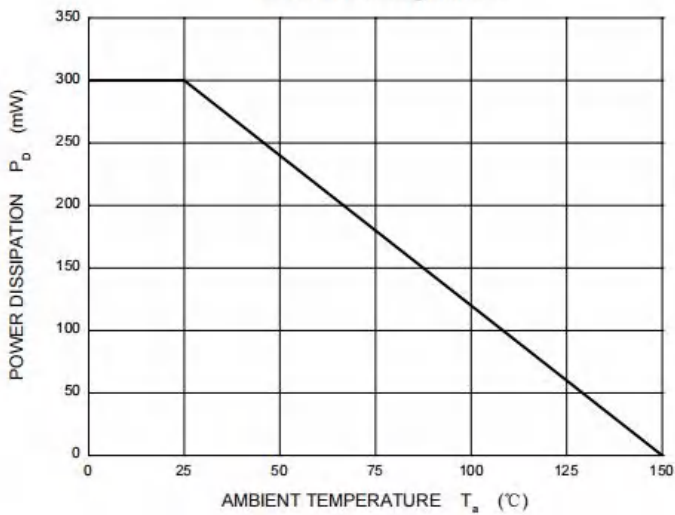



SOT-23 Package Outline Dimensions

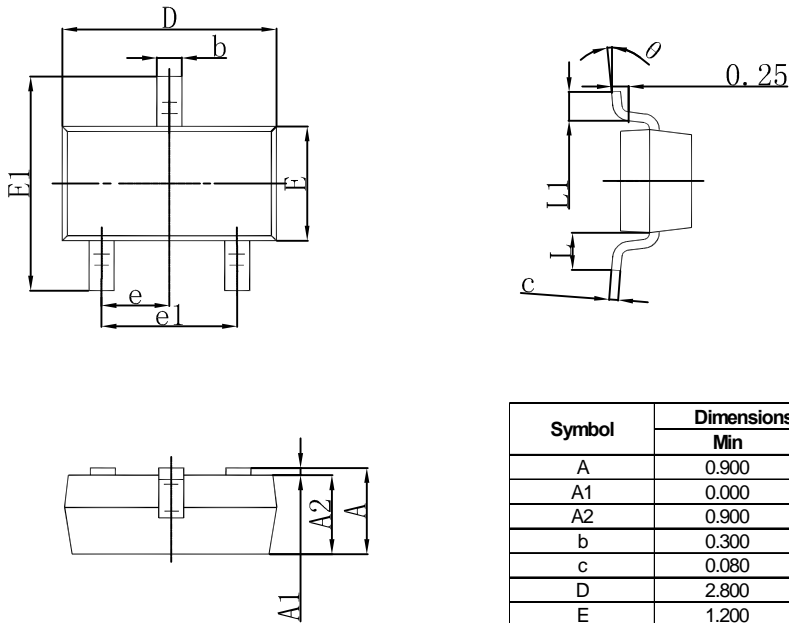

Symbol	Dimensions In Millimeters		Dimensions In Inches	
	Min	Max	Min	Max
A	0.900	1.150	0.035	0.045
A1	0.000	0.100	0.000	0.004
A2	0.900	1.050	0.035	0.041
b	0.300	0.500	0.012	0.020
c	0.080	0.150	0.003	0.006
D	2.800	3.000	0.110	0.118
E	1.200	1.400	0.047	0.055
E1	2.250	2.550	0.089	0.100
e	0.950 TYP		0.037 TYP	
e1	1.800	2.000	0.071	0.079
L	0.550 REF		0.022 REF	
L1	0.300	0.500	0.012	0.020
θ	0°	8°	0°	8°

SOT-23 Suggested Pad Layout

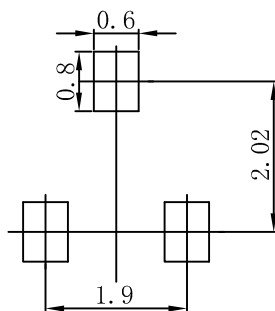

- Note:
1. Controlling dimension: in millimeters.
 2. General tolerance: $\pm 0.05\text{mm}$.
 3. The pad layout is for reference purposes only.



Attention

- Any and all HUA XUAN YANG ELECTRONICS products described or contained herein do not have specifications that can handle applications that require extremely high levels of reliability, such as life-support systems, aircraft's control systems, or other applications whose failure can be reasonably expected to result in serious physical and/or material damage. Consult with your HUA XUAN YANG ELECTRONICS representative nearest you before using any HUA XUAN YANG ELECTRONICS products described or contained herein in such applications.
- HUA XUAN YANG ELECTRONICS assumes no responsibility for equipment failures that result from using products at values that exceed, even momentarily, rated values (such as maximum ratings, operating condition ranges, or other parameters) listed in products specifications of any and all HUA XUAN YANG ELECTRONICS products described or contained herein.
- Specifications of any and all HUA XUAN YANG ELECTRONICS products described or contained herein stipulate the performance, characteristics, and functions of the described products in the independent state, and are not guarantees of the performance, characteristics, and functions of the described products as mounted in the customer's products or equipment. To verify symptoms and states that cannot be evaluated in an independent device, the customer should always evaluate and test devices mounted in the customer's products or equipment.
- HUA XUAN YANG ELECTRONICS CO.,LTD. strives to supply high-quality high-reliability products. However, any and all semiconductor products fail with some probability. It is possible that these probabilistic failures could give rise to accidents or events that could endanger human lives, that could give rise to smoke or fire, or that could cause damage to other property. When designing equipment, adopt safety measures so that these kinds of accidents or events cannot occur. Such measures include but are not limited to protective circuits and error prevention circuits for safe design, redundant design, and structural design.
- In the event that any or all HUA XUAN YANG ELECTRONICS products(including technical data, services) described or contained herein are controlled under any of applicable local export control laws and regulations, such products must not be exported without obtaining the export license from the authorities concerned in accordance with the above law.
- No part of this publication may be reproduced or transmitted in any form or by any means, electronic or mechanical, including photocopying and recording, or any information storage or retrieval system, or otherwise, without the prior written permission of HUA XUAN YANG ELECTRONICS CO.,LTD.
- Information (including circuit diagrams and circuit parameters) herein is for example only ; it is not guaranteed for volume production. HUA XUAN YANG ELECTRONICS believes information herein is accurate and reliable, but no guarantees are made or implied regarding its use or any infringements of intellectual property rights or other rights of third parties.
- Any and all information described or contained herein are subject to change without notice due to product/technology improvement, etc. When designing equipment, refer to the "Delivery Specification" for the HUA XUAN YANG ELECTRONICS product that you intend to use.