

N-Channel 20-V(D-S) MOSFET

V(BR)DSS	RDS(on)MAX	ID
20 V	22mΩ@4.5V	6.5A
	26mΩ@2.5V	
	30mΩ@1.8V	

FEATURE:

- ※ TrenchFET Power MOSFET
- ※ ESD Rating:2000V HBM

DESCRIPTION :

The AO3416 uses advanced trench technology to provide excellent RDS(ON), low gate charge and operation with gate voltages as low as 1.8V. This device is suitable for use as a load switch or in PWM applications. It is ESD protected.

MARKING:

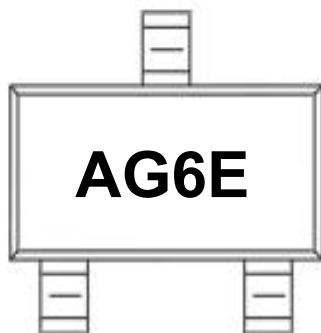

Equivalent Circuit:

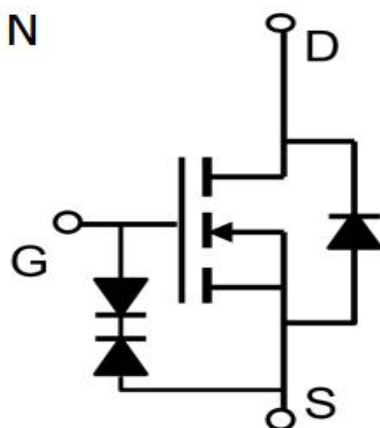

SOT-23

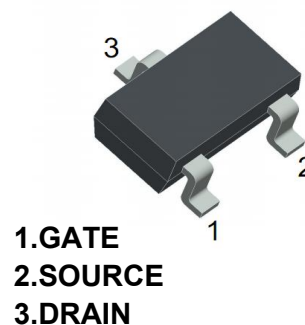

Mosfet Maximum ratings (Ta=25°C unless otherwise noted)

Parameter	Symbol	Value	Unit
Drain-Source Voltage	VDS	20	V
Gate-Source Voltage	VGS	±8	
Continuous Drain Current	ID	6.5	A
Pulsed drain current *	IDM	30	
Power Dissipation	PD	1.4	W
Thermal Resistance from Junction to Ambient	RθJA	125	°C/W
Junction Temperature	TJ	150	°C
Storage Temperature	TSTG	-55~+150	°C

* Repetitive rating : Pulse width limited by maximum junction temperature.

MOSFET ELECTRICAL CHARACTERISTICS

Static Electrical Characteristics (Ta = 25 °C Unless Otherwise Noted)

Parameter	Symbol	Test Condition	Min	Typ	Max	Unit
Static Parameters						
Drain-source breakdown voltage	V(BR)DSS	VGS = 0V, ID =250μA	20			V
Gate-threshold voltage	VGS(th)	VDS =VGS, ID =250μA	0.4		1	V
Gate-body leakage	IGSS	VDS =0V, VGS =±8V			±10	μA
Zero gate voltage drain current	IDSS	VDS =20V, VGS =0V			1	μA
Drain-source on-resistancea	RDS(on)	VGS =4.5V, ID = 1A		16	22	mΩ
		VGS =2.5V, ID = 1A		19	26	mΩ
		VGS =1.8V, ID = 1A		23	30	mΩ
Forward transconductancea	gfs	VDS =4.5V, ID = 6.5A		29		S
Diode forward voltage	VSD	IS= 1A,VGS=0V		0.8	1.2	V
Maximum Body-Diode Continuous Current	IS				2.5	A
Dynamic Parameters						
Input capacitance	Ciss	VDS =10V, VGS =0V, f=1MHz		1160		pF
Output capacitance	Coss			187		pF
Reverse transfer capacitanceb	Crss			146		pF
Gate resistance	Rg	f =1MHz		1.5		Ω
Switching Parameters						
Turn-on delay time	td(on)	VGS=10V, VDS=10V RL=2.6Ω, RGEN=3Ω		6.2		ns
Rise time	tr			12.7		ns
Turn-off delay time	td(off)			51.7		ns
Fall time	tf			16		ns
Total gate charge	Qg	VDS = 10V,VGS = 10V, ID =6.5A		16		nC
Gate-source charge	Qgs			0.8		nC
Gate-drain charge	Qgd			3.8		nC
Body Diode Reverse Recovery Time	Trr	IF= 6.5A, dI/dt=100A/μs		17.7		ns
Body Diode Reverse Recovery Charge	Qrr	IF= 6.5A, dI/dt=100A/μs		6.7		nC

Note :

1. These parameters have no way to verify.
2. Pulse Test ; Pulse Width ≤300μs, Duty Cycle ≤0.5%.

TYPICAL ELECTRICAL AND THERMAL CHARACTERISTICS

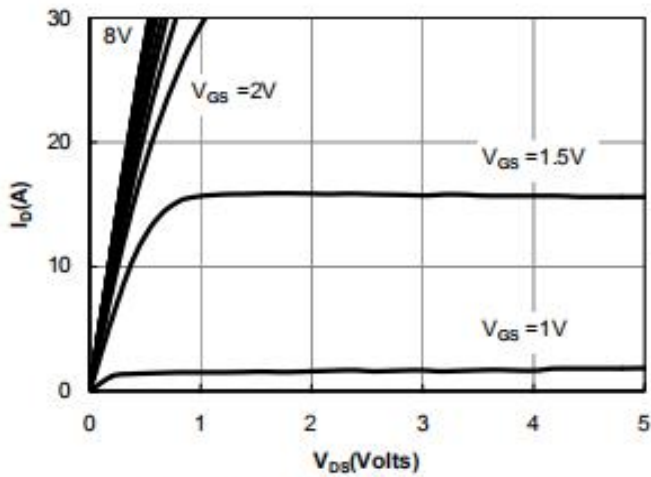

Figure 1: On-Regions Characteristics

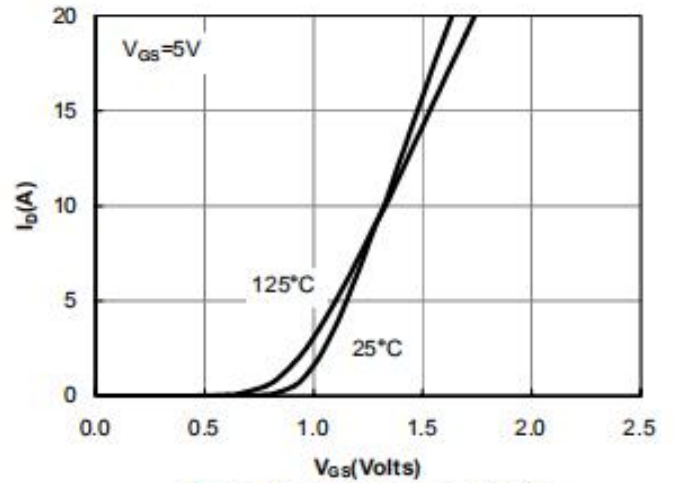

Figure 2: Transfer Characteristics

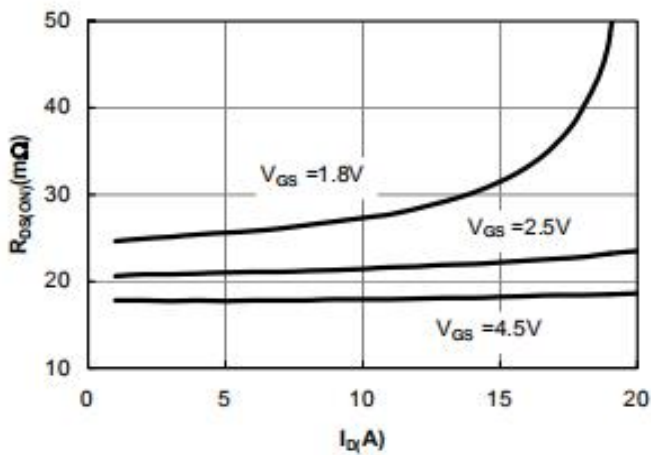

Figure 3: On-Resistance vs. Drain Current and Gate Voltage

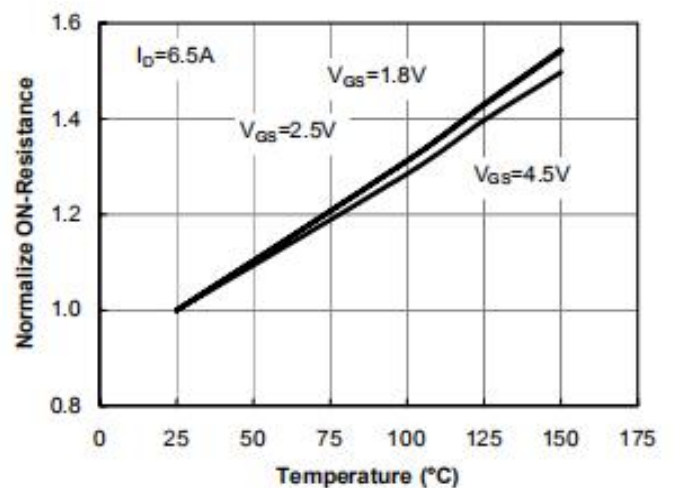

Figure 4: On-Resistance vs. Junction Temperature

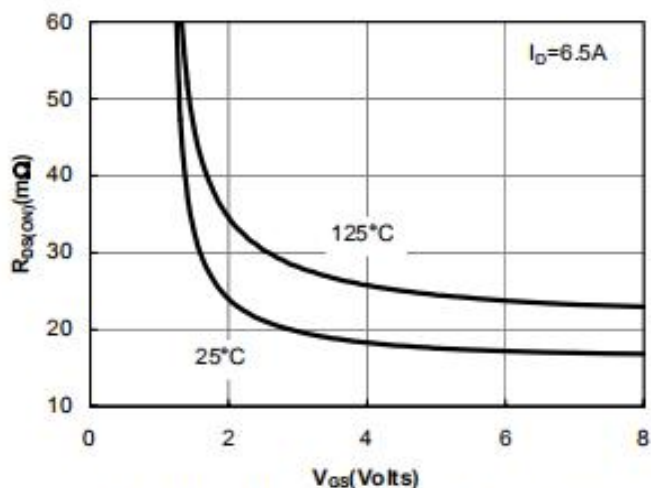

Figure 5: On-Resistance vs. Gate-Source Voltage

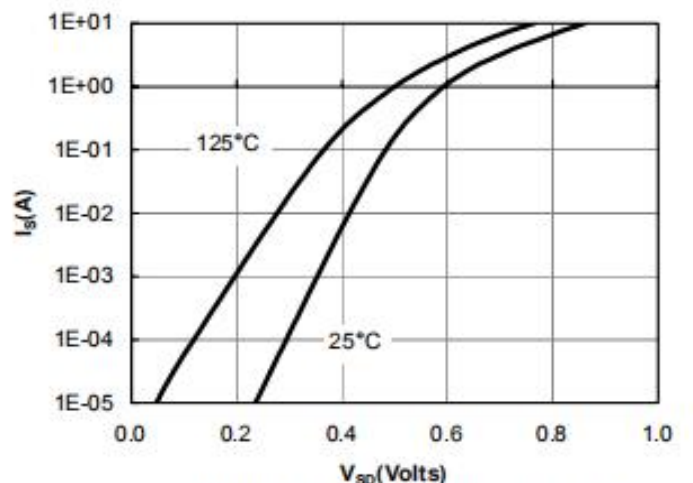

Figure 6: Body-Diode Characteristics

TYPICAL ELECTRICAL AND THERMAL CHARACTERISTICS

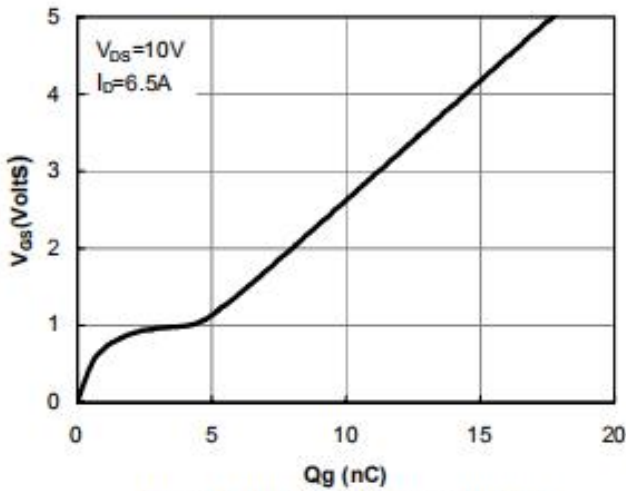

Figure 7: Gate-Charge Characteristics

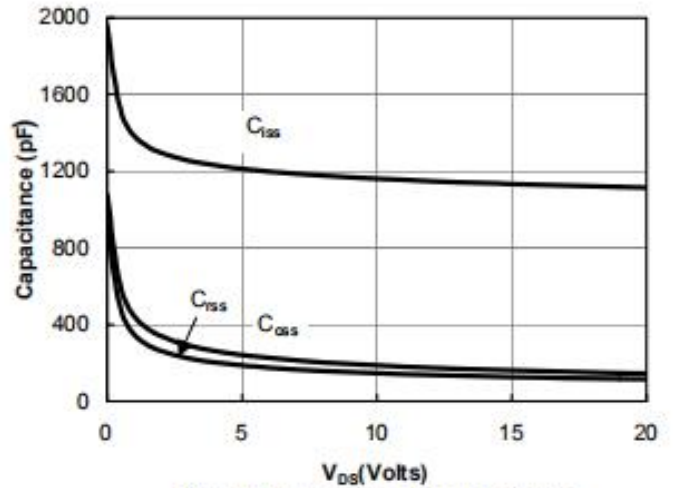

Figure 8: Capacitance Characteristics

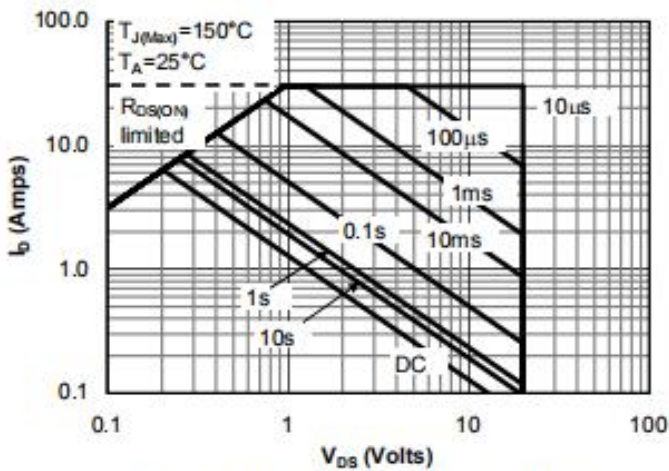

Figure 9: Maximum Forward Biased Safe Operating Area (Note E)

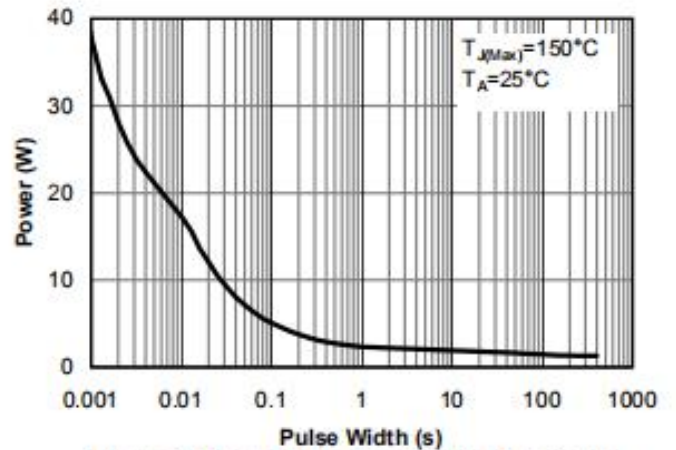

Figure 10: Single Pulse Power Rating Junction-to-Ambient (Note E)

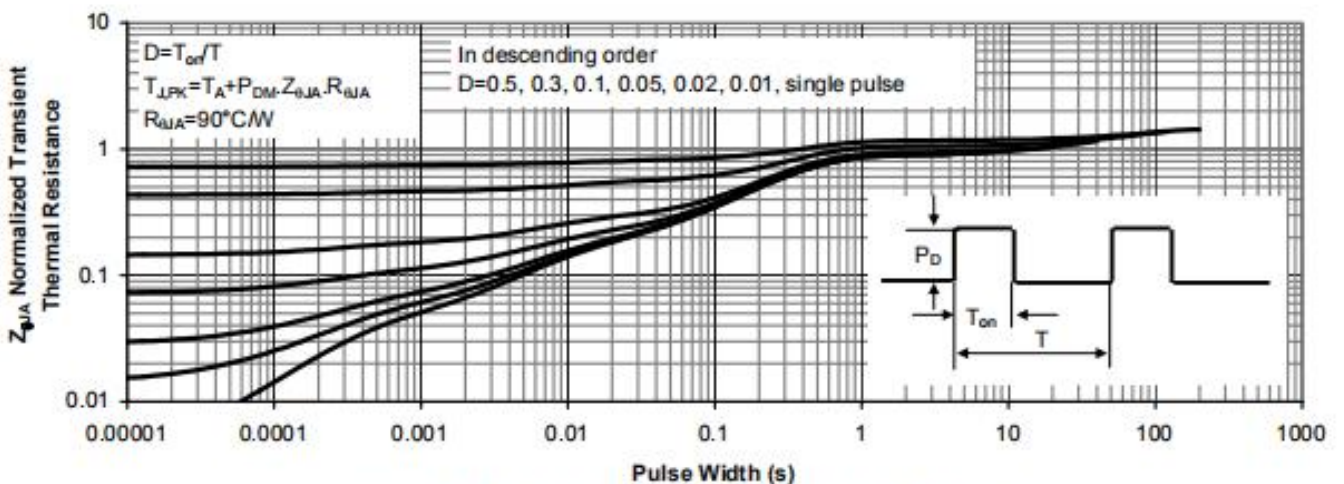
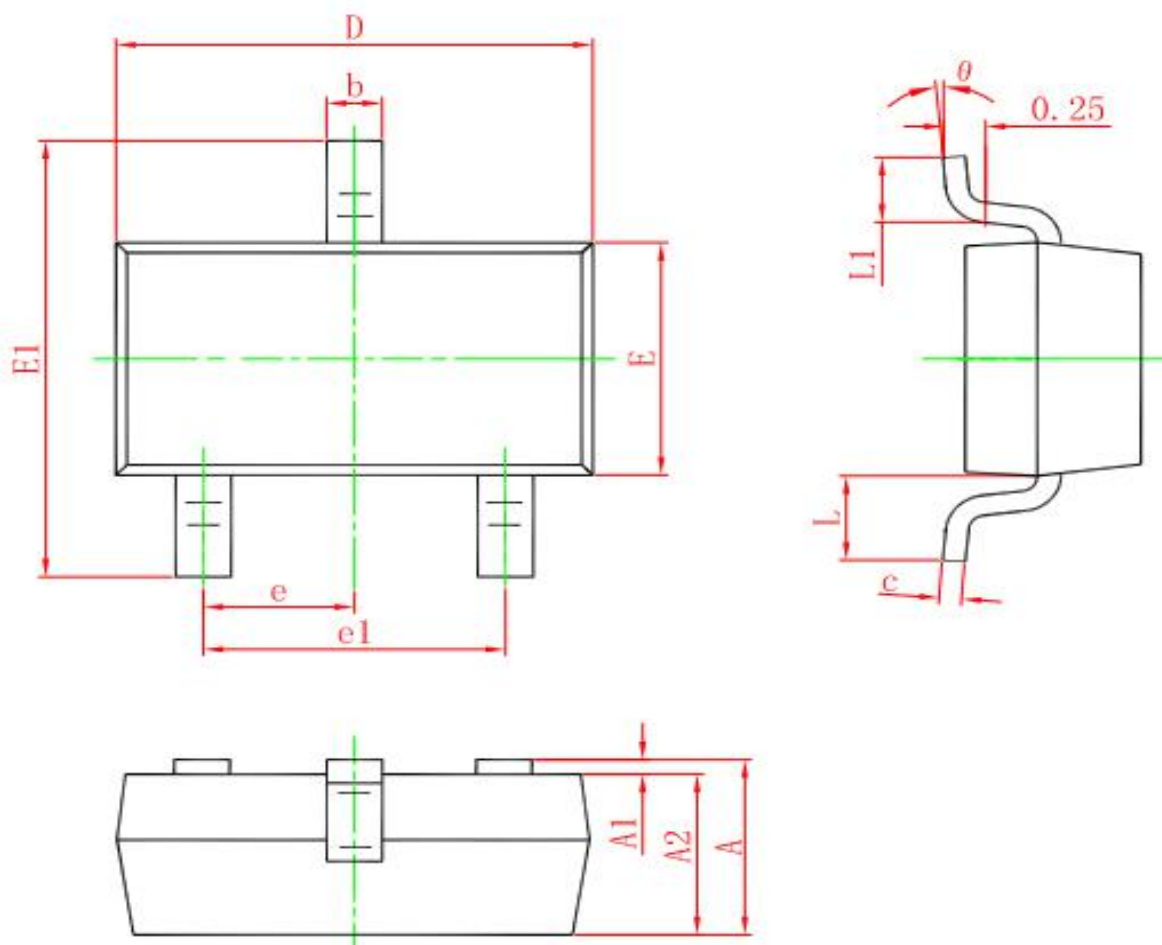

Figure 11: Normalized Maximum Transient Thermal Impedance

SOT-23 PACKAGE OUTLINE DIMENSIONS



Symbol	Dimensions In Millimeters		Dimensions In Inches	
	Min.	Max.	Min.	Max.
A	0.900	1.150	0.035	0.045
A1	0.000	0.100	0.000	0.004
A2	0.900	1.050	0.035	0.041
b	0.300	0.500	0.012	0.020
c	0.080	0.150	0.003	0.006
D	2.800	3.000	0.110	0.118
E	1.200	1.400	0.047	0.055
E1	2.250	2.550	0.089	0.100
e	0.950 TYP.		0.037 TYP.	
e1	1.800	2.000	0.071	0.079
L	0.550 REF.		0.022 REF.	
L1	0.300	0.500	0.012	0.020
θ	0°	8°	0°	8°