



TAIWAN TONGJIA OPTOELECTRONICS TECHNOLOGY CO., LTD

GUANGDONG TONGJIA OPTOELECTRONICS TECHNOLOGY CO., LTD

承認書

Specification For Approval

Customer: (客戶)

Description: (產品描述)

255直插共陰霧狀RGB

Part number: (產品型號)

TJ-L255FSXHMCSLCRGB-A5

Date: (日期)

Approved By: (客戶承認)

--

Prepared By: (我司承認)

Approval	Check	Design	Sales

核准

審核

製作

業務

Customer Service Hotline: **400-676-8616**

TEL: 0769-8662 5999 0769-8200 2226

E-MAIL : dg@togialed.com

FAX: 0769-8200 2227

WEB: www.togialed.com

Features :

- * Low power consumption
- * Small efficiency.
- * Versatile mounting on p.c board or panel.
- * I.C compatible/ low current requirement.
- * Package Dimensions :

Unit : mm

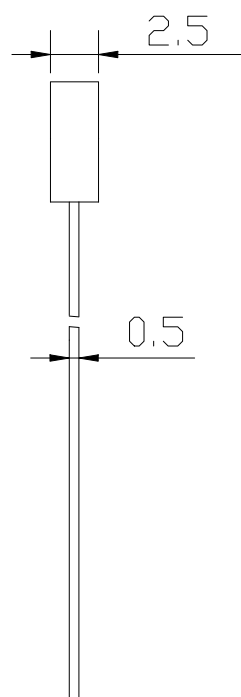
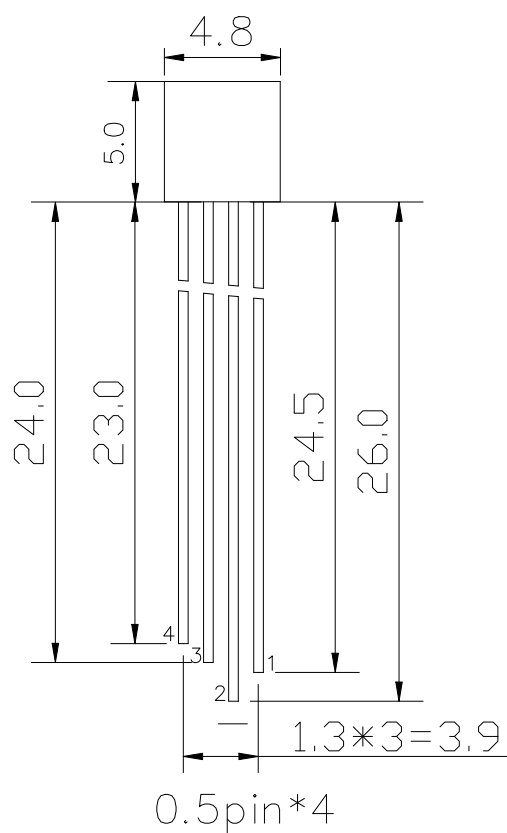

- 1、 RED
- 2、 COMMON
- 3、 GREEN
- 4、 BLUE

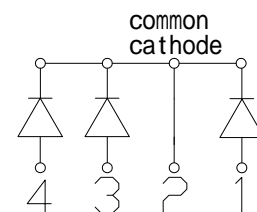

Note :

- 1 : All dimensions are in millimeters (inches).
- 2 : Tolerance is $\pm 0.25\text{mm}$ (.010") unless otherwise noted.
- 3 : Specifications are subject to change without notices.

4. parameter

4.1 The limit parameter (room temperature 25°C)

parameter	The numerical	Unit
Dissipation power	184	mW
Pulse current (1/10 work loops 0.1 millisecond pulse width)	60	mA
Working current (IF)	20	mA
Reverse voltage (VR)	5	V
Working temperature range	-20°C ~ +80°C	
Storage temperature range	-30°C ~ +100°C	
Soldering temperature from the roots (4.0 mm)	260°C for 5 Seconds	

Photoelectric parameters At room temperature 25°C

Parameter		min	Avg	max	Unit	Test Condition
Luminous intensity	Red	100	200	-----	mcd	If=20mA
	Green	400	600	-----	mcd	If=20mA
	Blue	100	200	-----	mcd	If=20mA
The wavelength(λ)	Red	620	-----	630	Nm	If=20mA
	Green	515	525	530	Nm	If=20mA
	Blue	460	-----	470	Nm	If=20mA
electric voltage	Red	1.8	-----	2.6	V	If=20mA
	Green	2.8	-----	3.6	V	If=20mA
	Blue	2.8	-----	3.6	V	If=20mA
Reverse current			-----	5	μA	Vr=5V

Selection Guide:

Colloid color	Chip		
	Material	Emitting light colors	λp (nm)
White Diffused	GaASP/Gap	Red	620
	InGaN/GaN	Blue	465
	InGaN/GaN	Green	520

Selection Guide

Typical Electrical/Optical Characteristics Curves(25°C Ambient Temperature Unle

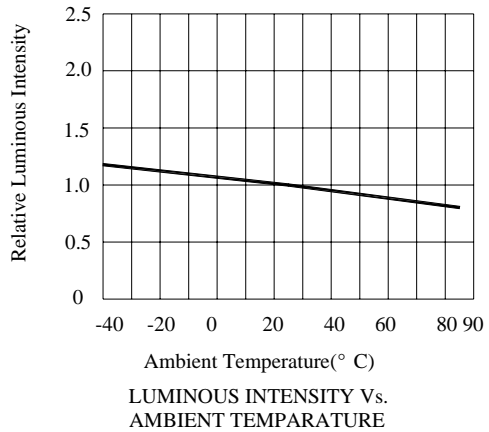
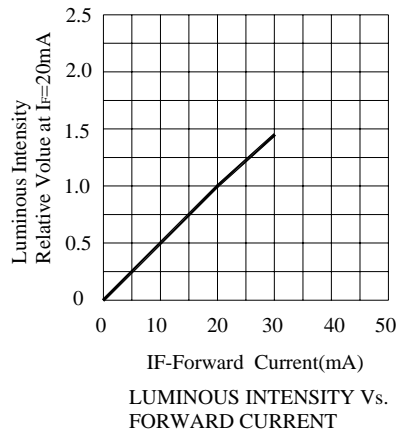
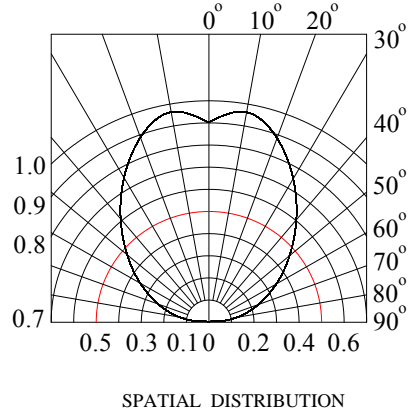

Selection Guide

Typical Electrical/Optical Characteristics Curves(25°C Ambient Temperature Unle

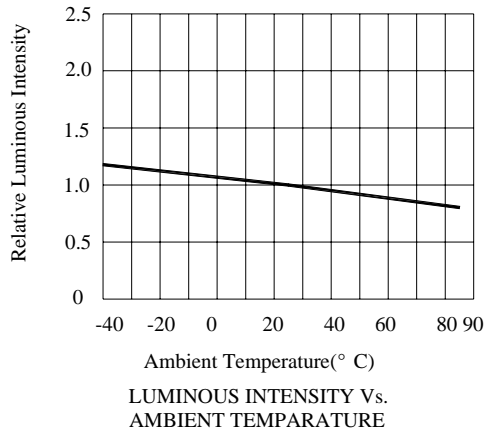
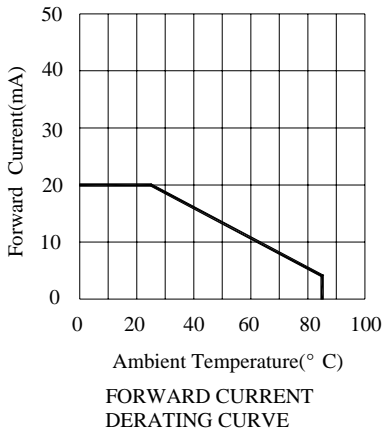
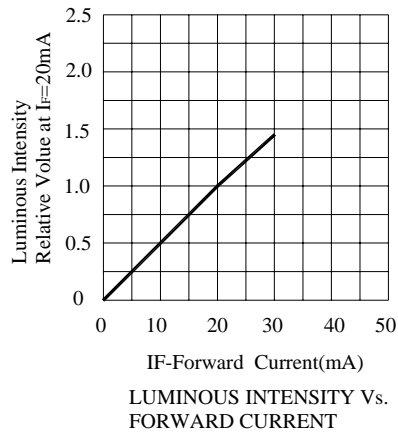
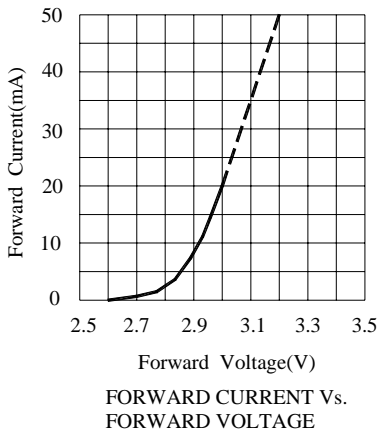
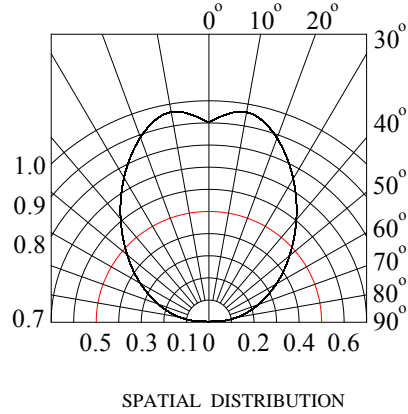
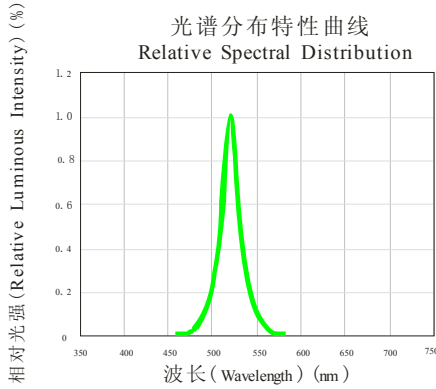

Selection Guide

Typical Electrical/Optical Characteristics Curves(25°C Ambient Temperature Unle

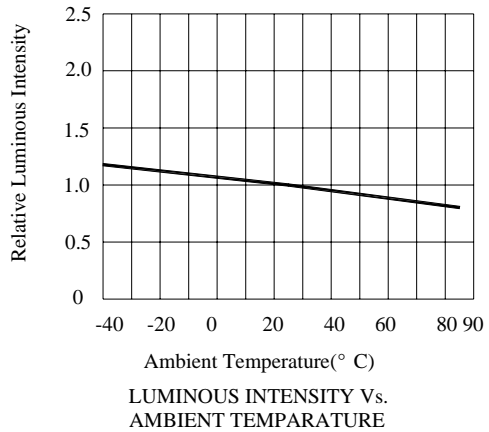
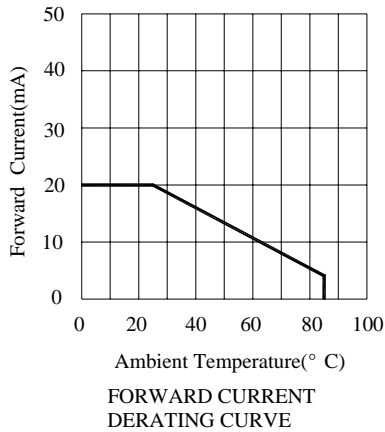
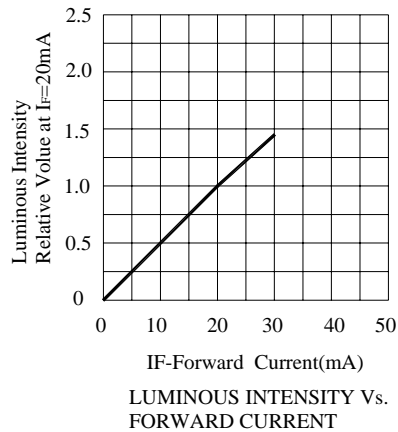
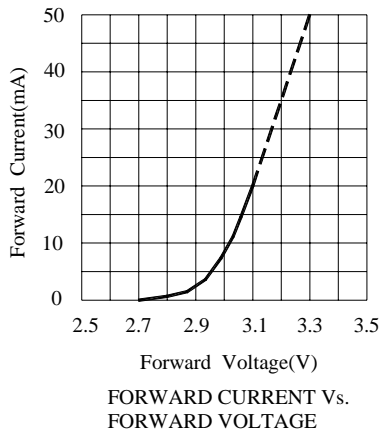
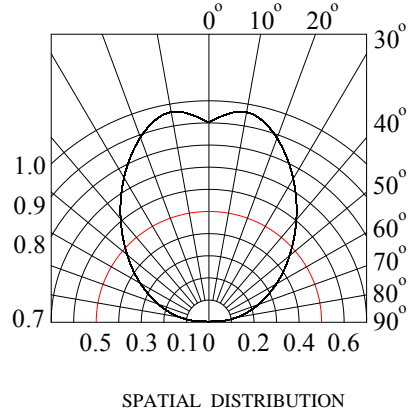
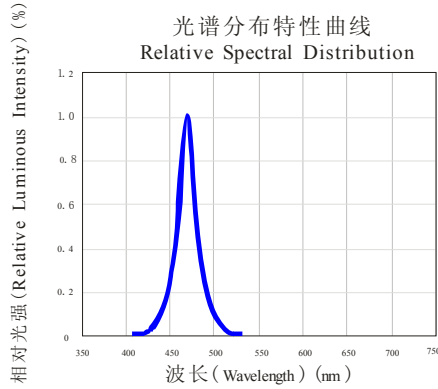

Labe

P/N: The product model

IV: Luminous intensity rank

VF: Forward voltage rank

TC: Color temperature

Q`T: number

QC: Production order

The packing

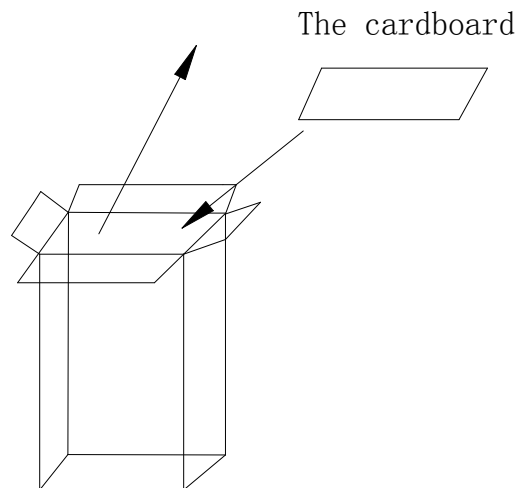
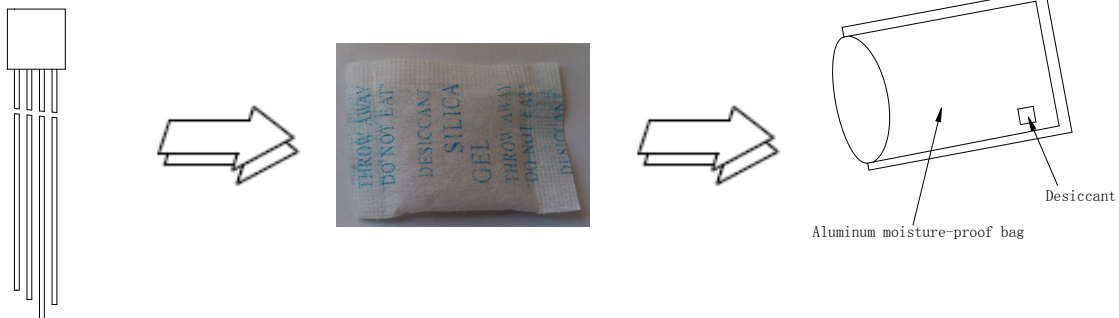

Package specification:

Package Method: packaged in anti-static bag White: Packaged in sorted light and color

1000pcs/bag General light 1000pcs/bag

note: Package specification mentioned above is under normal circumstance. Specific demand can be negotiated

Soldering

When soldering, for Lamp without stopper type and must be leave a minimum of 3mm clearance from the base of the lens to the soldering point. Do not apply any external stress to the lead frame during soldering while the LED is at high temperature.

Recommended soldering conditions:

Soldering Iron		Wave Soldering	
Temperature	300°C Max.	Pre-heat	100°C Max.
Soldering Time	3 sec. Max. (one time only)	Pre-heat Time	60 sec. Max.
		Solder Wave	260°C Max.
		Soldering Time	5 sec. Max.

Note:

a. Excessive soldering temperature and / or time might result in deformation of the LED lens or catastrophic failure of the LED.

Recommended Wave Soldering Profiles

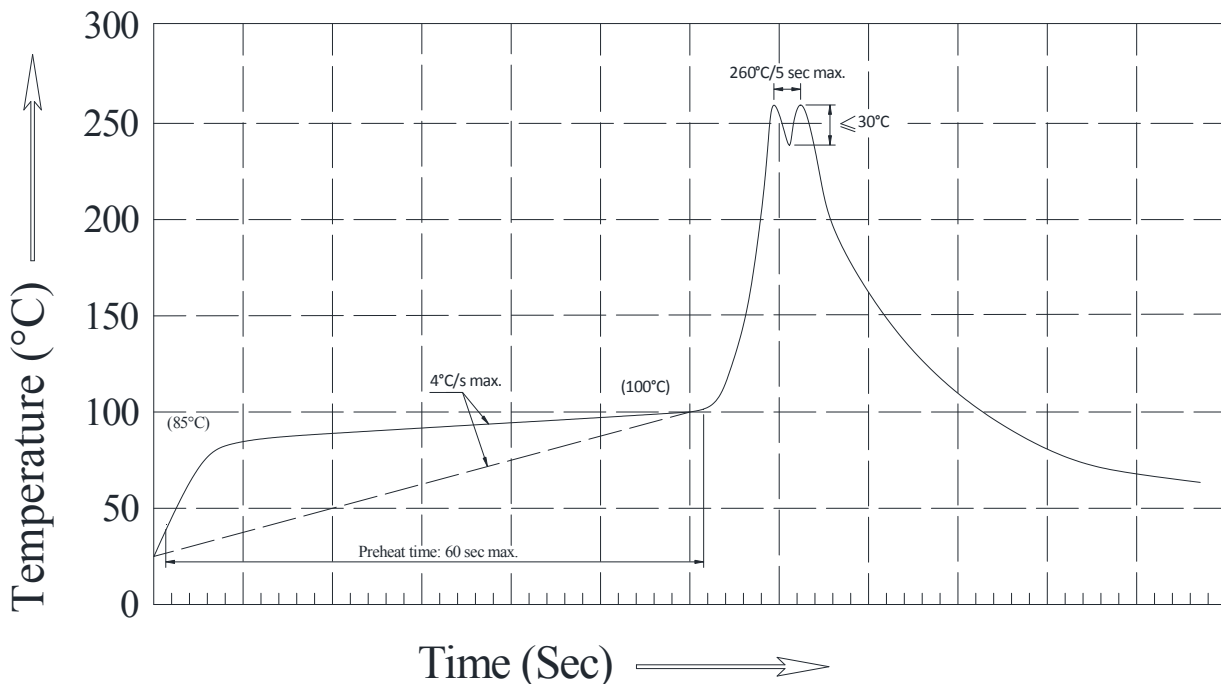

Notes:

- a. Recommend pre-heat temperature of 105° C or less (as measured with a thermocouple attached to the LED pins) prior to immersion in the solder wave with a maximum solder bath temperature of 265° C.
- b. Peak wave soldering temperature between 255° C ~ 265° C for 3 sec (5 sec max).
- c. Do not apply stress to the epoxy resin while the temperature is above 85° C.
- d. Fixtures should not incur stress on the component when mounting and during soldering process.
- e. SAC 305 solder alloy is recommended.
- f. No more than one wave soldering pass.

Supporter shaping :

Shaping of the supporter must be conducted before welding. While shaping, the bending position of the supporter must at least be located at 3mm from the bottom of the encapsulating resin. Also, avoid multiple bending on the same position. Please choose the appropriate apparatus to fixate the supporter in order to avoid exerting extra pressure on resin. Using the jointing section of the pin and resin as fulcrum is strictly prohibited since the pressure mounted would directly damage the internal illuminating structure and thus cause irreversible deflection of the product. Due to the same reason, the interval between the welding hole on the PCB board should be strictly matched with the pin interval of the product when assembling the product.

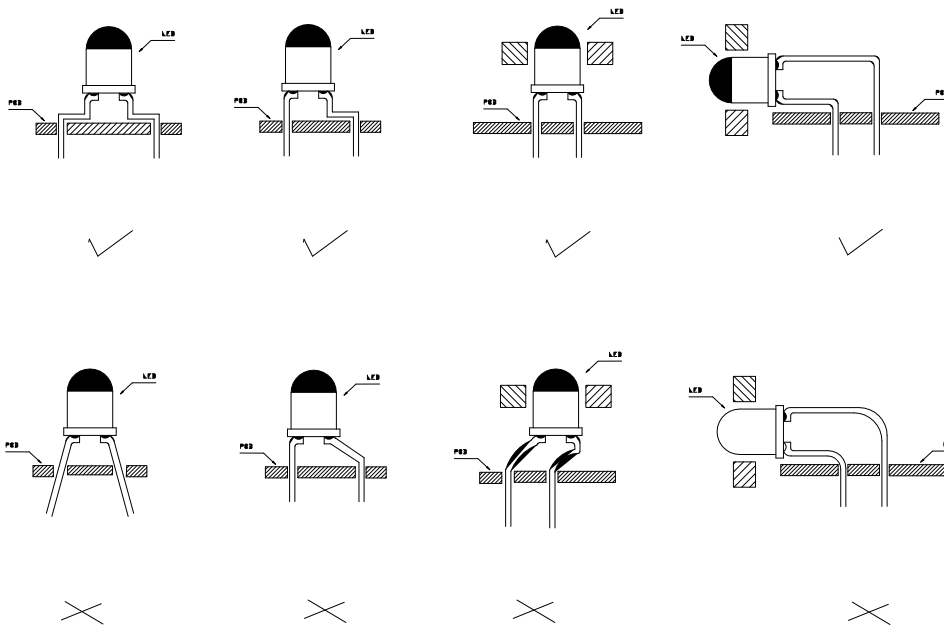

✓ correct mounting methods

✗ Incorrect mounting methods

Reliability experiment items and conditions

Serial number	Testing project	Test conditions	Sample quantity	Acceptance/rejection
1	Life test	Test current ; 20MA temperature ; 25°C Testing time ; 1000 hours	20	0/1
2	High temperature high humidity (static test)	temperature ; =+65°C humidity ; 90% RH Testing time ; 240 hours	20	0/1
3	Cold and hot impact	-40°C- +100°C 20min 10s 20min Testing time ; 100 cycle	20	0/1
4	High temperature storage	High temperature ; 100°C Testing time ; 1000 hours	20	0/1
5	Low temperature storage	Low temperature ; -40°C Testing time ; 1000 hours	20	0/1
6	temperature cycle	-40°C-- +100°C 60min 20min 60min Testing time ; 20A cycle	20	0/1
7	Reflow soldering	260°C (Max), The biggest not more than 5 seconds	20	0/1

note

Reliability experiment unqualified decision criteria

IV; Attenuation of more than 30% VF; Change more than 20% ;

1. The same project experimental results of the test must be completed within two hours
2. Testing must be in every experiment is completed. Material return to normal conditions to carry out

ESD protective

1 Electrostatic generation

1; Friction: in the daily life. Any two different material object contact after the separation, can produce a static electric · Static electricity and the most common method · Is triboelectrification ◦ The insulation material, the better · More let Easy triboelectrification ◦ In addition · Any two different material object contact after separation · Can also produce electrostatic ◦

2. Induction: in view of the conductive material is concerned, because the surface of the electronic can free flow, such as placed it in electric field because Gay repellent · Opposites attract · Are negative ions will transfer · In its surface can produce charge ◦

3. Transmission: in view of the conductive material is concerned, because the surface of the electronic can free flow · If charged object contact, will be charge transfer.

4. The harm of static electricity LED :

.1 For the moment's electric field or the heat generated by the current · Make LED local injury · For the performance of the leakage current increase quickly · Can still work · But the brightness is reduced (white light will change color), life is damaged ◦

5 Because the electric field or current failure LED insulating layer · Make device can't work (destroyed) · Performance for die lamp ◦

6; Electrostatic protection and elimination measures :

a. For the whole process (production, testing, packaging, etc.) All LED directly contact member must do it well Prevent and Eliminate electrostatic measures, basically have: workshop laid anti-static floor and well grounded ◦

b. Table for esd workstation, the production of the good earth

c. Operator wear anti-static clothing, with wrist strap, gloves or foot ring ◦

d. Application of ion fan, welding solder iron well grounding measures ◦

e. The package antistatic material
