

# Femtoampere Input Bias Current Electrometer Amplifier

## 1 FEATURES

- **Low Input Bias Current:**
  - $\pm 200\text{fA}$  (Max) at  $T_A = 25^\circ\text{C}$
- **Low Offset Voltage:  $54\mu\text{V}$  typical @5V supply**
- **Offset voltage drift:  $\pm 5\mu\text{V}/^\circ\text{C}$  typical**
- **Integrated guard buffer with  $400\mu\text{V}$  maximum offset**
- **Low voltage noise density:  $14\text{nV}/\sqrt{\text{Hz}}$  at 10 kHz**
- **Wide bandwidth: 3.3MHz unity-gain crossover**
- **Supply voltage: 5V to 25V ( $\pm 2.5\text{V}$  to  $\pm 12.5\text{V}$ )**
- **Operating temperature:  $-40^\circ\text{C}$  to  $+125^\circ\text{C}$**
- **Micro SIZE PACKAGES: SOIC-8(SOP8)**

## 2 APPLICATIONS

- **Laboratory and analytical instrumentation: spectrophotometers, chromatographs, mass spectrometers, and potentiostatic and amperostatic coulometry**
- **Instrumentation: picoammeters and coulombmeters**
- **Transimpedance Amplifier (TIA) for photodiodes, ion chambers, and working electrode measurements**
- **High Impedance Buffering for Chemical Sensors and Capacitive Sensors**

## 3 DESCRIPTIONS

The RS8491 is a femtoampere ( $10^{-15}\text{A}$ ) level input bias current operational amplifier suitable for use as an electrometer that also includes an integrated guard buffer. It has an operating voltage range of 5V to 25V, enabling it to operate in conventional 5V and 25V single supply systems as well as  $\pm 2.5\text{V}$  and  $\pm 12.5\text{V}$  dual supply systems.

The integrated guard buffer isolates the input pins from leakage in the printed circuit board (PCB), minimizes board component count, and enables easy system design. The RS8491 is available in an industry-standard surface-mount 8-lead SOIC package with a unique pinout optimized to prevent signals from coupling between the sensitive input pins, the power supplies, and the output pin while enabling easy routing of the guard ring traces.

The RS8491 also offers low offset voltage, low offset drift, and low voltage and current noise needed for the types of applications that require such low leakages. To maximize the dynamic range of the system, the RS8491 has a rail-to-rail output stage.

The RS8491 is available in Green SOIC-8(SOP8) packages. It operates over an ambient temperature range of  $-40^\circ\text{C}$  to  $+125^\circ\text{C}$ .

**Device Information <sup>(1)</sup>**

PART NUMBER	PACKAGE	BODY SIZE (NOM)
RS8491	SOIC-8(SOP8)	4.90mm x 3.90mm

(1) For all available packages, see the orderable addendum at the end of the data sheet.

## Table of Contents

<b>1 FEATURES</b> .....	1
<b>2 APPLICATIONS</b> .....	1
<b>3 DESCRIPTIONS</b> .....	1
<b>4 Revision History</b> .....	3
<b>5 PACKAGE/ORDERING INFORMATION</b> <sup>(1)</sup> .....	4
<b>6 Pin Configuration and Functions (Top View)</b> .....	5
<b>7 SPECIFICATIONS</b> .....	6
7.1 Absolute Maximum Ratings .....	6
7.2 ESD Ratings .....	6
7.3 Recommended Operating Conditions .....	6
7.4 ELECTRICAL CHARACTERISTICS .....	7
7.5 TYPICAL CHARACTERISTICS .....	11
<b>8 Application and Implementation</b> .....	16
8.1 ESD STRUCTURE .....	16
8.2 GUARD BUFFER .....	16
<b>9 PACKAGE OUTLINE DIMENSIONS</b> .....	17
<b>10 TAPE AND REEL INFORMATION</b> .....	18

## 4 Revision History

Note: Page numbers for previous revisions may differ from page numbers in the current version.

Version	Change Date	Change Item
A.1	2023/11/29	Initial version completed

**5 PACKAGE/ORDERING INFORMATION <sup>(1)</sup>**

Orderable Device	Package Type	Pin	Channel	Op Temp(°C)	Device Marking <sup>(2)</sup>	MSL <sup>(3)</sup>	Package Qty
RS8491XK	SOIC-8(SOP8)	8	1	-40°C ~125°C	RS8491	MSL1	Tape and Reel,4000

## NOTE:

- (1) This information is the most current data available for the designated devices. This data is subject to change without notice and revision of this document. For browser-based versions of this data sheet, refer to the right-hand navigation.
- (2) There may be additional marking, which relates to the lot trace code information (data code and vendor code), the logo or the environmental category on the device.
- (3) MSL, The Moisture Sensitivity Level rating according to the JEDEC industry standard classifications.

## 6 Pin Configuration and Functions (Top View)

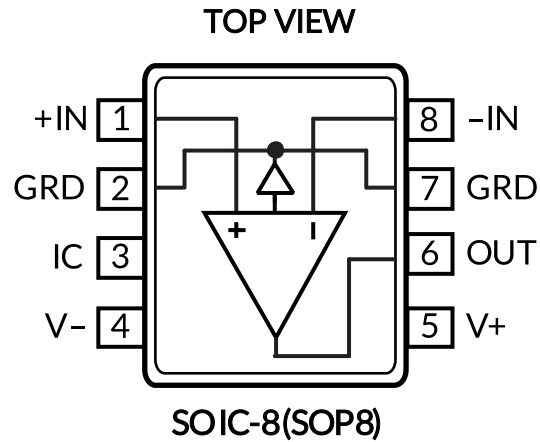

### Pin Description

NAME	PIN	I/O <sup>(1)</sup>	DESCRIPTION
	SOIC-8(SOP8)		
+IN	1	I	Noninverting input
GRD	2	-	Guard
IC	3	I	Internal Connection. This pin must be connected to V- or left unconnected
V-	4	P	Negative supply voltage
V+	5	P	Positive supply voltage
OUT	6	O	Output
GRD	7		Guard
-IN	8	I	Inverting input

(1) I = Input, O = Output, P=Power.

## 7 SPECIFICATIONS

### 7.1 Absolute Maximum Ratings

Over operating free-air temperature range (unless otherwise noted) <sup>(1)</sup>

		MIN	MAX	UNIT
Voltage	Supply, $V_S = (V+) - (V-)$	-0.7	28	V
	Signal input pin <sup>(2)</sup>	(V-)-0.5	(V+) +0.5	
	Signal output pin <sup>(3)</sup>	(V-)-0.5	(V+) +0.5	
Current	Signal input pin <sup>(2)</sup>	-10	10	mA
	Signal output pin <sup>(3)</sup>	-10	10	mA
	Output short-circuits <sup>(4)</sup>	Continuous		
$\theta_{JA}$	Package thermal impedance <sup>(5)</sup>	SOIC-8(SOP8)	110	°C/W
Temperature	Operating range, $T_A$	-40	125	°C
	Junction, $T_J$ <sup>(6)</sup>	-40	150	
	Storage, $T_{stg}$	-65	150	

(1) Stresses above these ratings may cause permanent damage. Exposure to absolute maximum conditions for extended periods may degrade device reliability. These are stress ratings only, and functional operation of the device at these or any other conditions beyond those specified is not implied.

(2) Input terminals are diode-clamped to the power-supply rails. Input signals that can swing more than 0.5V beyond the supply rails should be current-limited to 10mA or less.

(3) Output terminals are diode-clamped to the power-supply rails. Output signals that can swing more than 0.5V beyond the supply rails should be current-limited to  $\pm 10$ mA or less.

(4) Short-circuit to ground, one amplifier per package.

(5) The package thermal impedance is calculated in accordance with JESD-51.

(6) The maximum power dissipation is a function of  $T_{J(MAX)}$ ,  $R_{\theta JA}$ , and  $T_A$ . The maximum allowable power dissipation at any ambient temperature is  $P_D = (T_{J(MAX)} - T_A) / R_{\theta JA}$ . All numbers apply for packages soldered directly onto a PCB.

### 7.2 ESD Ratings

The following ESD information is provided for handling of ESD-sensitive devices in an ESD protected area only.

			VALUE	UNIT
$V_{(ESD)}$	Electrostatic discharge	Human-body model (HBM), MIL-STD-883K METHOD 3015.9	$\pm 2000$	V
		Charged-device model (CDM), ANSI/ESDA/JEDEC JS-002-2018	$\pm 1500$	
		Machine Model (MM), JEDEC EIA/JESD22-A114	$\pm 200$	



#### ESD SENSITIVITY CAUTION

ESD damage can range from subtle performance degradation to complete device failure. Precision integrated circuits may be more susceptible to damage because very small parametric changes could cause the device not to meet its published specifications.

### 7.3 Recommended Operating Conditions

Over operating free-air temperature range (unless otherwise noted)

		MIN	NOM	MAX	UNIT
Supply voltage, $V_S = (V+) - (V-)$	Single-supply	5		25	V
	Dual-supply	$\pm 2.5$		$\pm 12.5$	

## 7.4 ELECTRICAL CHARACTERISTICS

(At  $T_A=+25^\circ\text{C}$ ,  $V_S=5\text{V}$ ,  $V_{CM}=V_{OUT}=V_S/2$ , and  $R_L=10\text{k}\Omega$  connected to  $V_S/2$ , Full =  $-40^\circ\text{C}$  to  $+125^\circ\text{C}$ , unless otherwise noted.)<sup>(1)</sup>

PARAMETER	SYMBOL	CONDITION	TEMP	MIN <sup>(2)</sup>	TYP <sup>(3)</sup>	MAX <sup>(2)</sup>	UNIT
<b>INPUT BIAS CURRENT</b>							
Input Bias Current <sup>(4)(5)</sup>	$I_B$		25°C		±50	±200	fA
Input Offset Current <sup>(4)</sup>	$I_{OS}$		25°C		±50	±200	fA
<b>OFFSET VOLTAGE</b>							
Input Offset Voltage	$V_{OS}$	$V_{CM}=V_S/2$	25°C		±54	±400	μV
		$V_{CM}=1.5\text{V to }3\text{V}$	-40°C to 85°C			±1000	
		$V_{CM}=0\text{V to }3\text{V}$	25°C			±600	
Input Offset Voltage Average Drift	$V_{OS Tc}$	$V_{CM}=1.5\text{V to }3\text{V}$	-40°C to 85°C		±5		μV/°C
Power-Supply Rejection Ratio	PSRR	$V_S=5\text{V to }25\text{V}$	25°C	83	106		dB
			-40°C to 125°C	70			
<b>NOISE</b>							
Input Voltage Noise	$e_n$ p-p	$f=0.1\text{Hz to }10\text{Hz}$	25°C		5		μV <sub>PP</sub>
Input Voltage Noise Density	$e_n$	$f=10\text{Hz}$	25°C		80		nV/√Hz
		$f=1\text{KHz}$			16		
		$f=10\text{KHz}$			14		
Input Current Noise Density	$I_n$	$f=0.1\text{Hz}$	25°C		0.85		fA/√Hz
Total harmonic distortion + noise	THD+N	$A_V=1$ , $f=1\text{kHz}$ , $V_{IN}=0.5\text{V rms}$	25°C		0.003		%
<b>INPUT VOLTAGE</b>							
Common-Mode Voltage Range	$V_{CM}$	$V_S=5\text{V}$	-40°C to 125°C	0		3.0	V
Common-Mode Rejection Ratio	CMRR	$V_{CM}=1.5\text{V to }3.0\text{V}$	25°C	83	102		dB
			-40°C to 125°C	70			
			$V_{CM}=0\text{ to }3.0\text{V}$	25°C	65		
<b>INPUT IMPEDANCE</b>							
Input Resistance	$R_{IN}$				> 20		TΩ
Input Capacitance	$C_{IN}$				8		pF
<b>OPEN-LOOP GAIN</b>							
Open-Loop Voltage Gain	$A_{OL}$	$R_L=10\text{k}\Omega$ to $V_{CM}$ , $V_{OUT}=0.2\text{V to }4.3\text{V}$	25°C	110	130		dB
			-40°C to 125°C	105			
<b>FREQUENCY RESPONSE</b>							
Unity gain bandwidth	GBW	$V_{IN}=50\text{mV rms}$ , $R_L=10\text{k}\Omega$ , $C_L=10\text{pF}$ , $A_V=11$	25°C		3.3		MHz
Unity-Gain Crossover	UGC	$V_{IN}=50\text{mV rms}$ , $R_L=10\text{k}\Omega$ , $C_L=10\text{pF}$ , $A_{VO}=1$	25°C		3.3		MHz
Slew Rate <sup>(8)</sup>	SR	$R_L=10\text{k}\Omega$ , $C_L=10\text{pF}$ , $A_V=1$	25°C		2.1		V/μs
Settling Time	$t_s$	$V_{IN}=1\text{V step}$ , $R_L=10\text{k}\Omega$ , $C_L=10\text{pF}$ , $A_V=-1$	25°C		1.4		μs
Overload Recovery Time	$t_{OR}$	$V_{IN} \times G \geq V_S$ , $G=-10$	25°C		1.0		μs
-3dB Closed-Loop Bandwidth	$f_{-3dB}$	$V_{IN}=20\text{mV rms}$ , $R_L=10\text{k}\Omega$ , $C_L=10\text{pF}$ , $A_V=1$	25°C		6		MHz
Phase Margin	ΦM	$V_{IN}=10\text{mV rms}$ , $R_L=10\text{k}\Omega$ , $C_L=10\text{pF}$ , $A_{VO}=1$	25°C		60		degree

## ELECTRICAL CHARACTERISTICS (Continued)

(At  $T_A=+25^{\circ}\text{C}$ ,  $V_S=5\text{V}$ ,  $V_{\text{CM}}=V_{\text{OUT}}=V_S/2$ , and  $R_L=10\text{k}\Omega$  connected to  $V_S/2$ , Full =  $-40^{\circ}\text{C}$  to  $+125^{\circ}\text{C}$ , unless otherwise noted.)<sup>(1)</sup>

PARAMETER	SYMBOL	CONDITION	TEMP	MIN <sup>(2)</sup>	TYP <sup>(3)</sup>	MAX <sup>(2)</sup>	UNIT
<b>OUTPUT</b>							
Output Voltage	$V_{\text{OH}}$	$R_L=2\text{K}\Omega$	25°C		4.92		V
			-40°C to 125°C	4.85			
	$V_{\text{OH}}$	$R_L=10\text{K}\Omega$	25°C		4.98		V
			-40°C to 125°C	4.95			
	$V_{\text{OL}}$	$R_L=2\text{K}\Omega$	25°C		133		mV
			-40°C to 125°C			160	
$R_L=10\text{K}\Omega$		25°C		29			
		-40°C to 125°C			40		
Output Source Current <sup>(6) (7)</sup>	$I_{\text{SOURCE}}$		25°C		30		mA
Output Sink Current <sup>(6) (7)</sup>	$I_{\text{SINK}}$				-20		
Closed-loop Output Impedance	$Z_{\text{O}}$	$f = 1\text{MHz}$ , $A_v=1$	25°C		40		$\Omega$
<b>POWER SUPPLY</b>							
Quiescent Current Per Amplifier	$I_{\text{Q}}$	$I_{\text{OUT}}=0\text{A}$	25°C		1.0	1.6	mA
			-40°C to 125°C			1.8	
<b>INTERNAL GUARD BUFFER</b>							
Guard Offset Voltage	$V_{\text{GOS}}$	$V_{\text{CM}}=1.5\text{V}$ to $3\text{V}$	25°C		$\pm 75$	$\pm 400$	$\mu\text{V}$
		$V_{\text{CM}}=1.5\text{V}$ to $3\text{V}$	-40°C to 125°C			$\pm 800$	
		$V_{\text{CM}}=0.1\text{V}$ to $3\text{V}$	25°C			$\pm 500$	
Guard Offset Voltage Drift	$\Delta V_{\text{GOS}}/\Delta T$		-40°C to 125°C		1		$\mu\text{V}/^{\circ}\text{C}$
Output Impedance	$Z_{\text{GOUT}}$		25°C		1		$\text{k}\Omega$
Output Voltage Range		$V_{\text{GOS}} < \pm 500\mu\text{V}$	25°C	0.1		3	V
-3dB Bandwidth	$f_{-3\text{dBGUARD}}$	$V_{\text{IN}} = 20\text{mV rms}$ , $C_L = 10\text{pF}$	25°C		3		MHz

NOTE:

- (1) Electrical table values apply only for factory testing conditions at the temperature indicated. Factory testing conditions result in very limited self-heating of the device.
- (2) Limits are 100% production tested at 25°C. Limits over the operating temperature range are ensured through correlations using statistical quality control (SQC) method.
- (3) Typical values represent the most likely parametric norm as determined at the time of characterization. Actual typical values may vary over time and will also depend on the application and configuration.
- (4) This parameter is ensured by design and/or characterization and is not tested in production.
- (5) Positive current corresponds to current flowing into the device.
- (6) The maximum power dissipation is a function of  $T_{\text{J(MAX)}}$ ,  $R_{\theta\text{JA}}$ , and  $T_{\text{A}}$ . The maximum allowable power dissipation at any ambient temperature is  $P_{\text{D}} = (T_{\text{J(MAX)}} - T_{\text{A}}) / R_{\theta\text{JA}}$ . All numbers apply for packages soldered directly onto a PCB.
- (7) Short circuit test is a momentary test.
- (8) Number specified is the slower of positive and negative slew rates.



## ELECTRICAL CHARACTERISTICS

(At  $T_A=+25^\circ\text{C}$ ,  $V_S=25\text{V}$ ,  $V_{CM}=V_{OUT}=V_S/2$ , and  $R_L=10\text{k}\Omega$  connected to  $V_S/2$ , Full =  $-40^\circ\text{C}$  to  $+125^\circ\text{C}$ , unless otherwise noted.)<sup>(1)</sup>

PARAMETER	SYMBOL	CONDITION	TEMP	MIN <sup>(2)</sup>	TYP <sup>(3)</sup>	MAX <sup>(2)</sup>	UNIT
<b>INPUT BIAS CURRENT</b>							
Input Bias Current <sup>(4)(5)</sup>	$I_B$		$25^\circ\text{C}$		$\pm 50$	$\pm 200$	fA
Input Offset Current <sup>(4)</sup>	$I_{OS}$		$25^\circ\text{C}$		$\pm 50$	$\pm 200$	fA
<b>OFFSET VOLTAGE</b>							
Input Offset Voltage	$V_{OS}$	$V_{CM}=V_S/2$	$25^\circ\text{C}$		$\pm 100$	$\pm 900$	$\mu\text{V}$
		$V_{CM}=1.5\text{V to }21\text{V}$	$-40^\circ\text{C to }85^\circ\text{C}$			$\pm 2000$	
		$V_{CM}=0\text{V to }23\text{V}$	$25^\circ\text{C}$			$\pm 2000$	
Input Offset Voltage Average Drift	$V_{OS Tc}$	$V_{CM}=1.5\text{V to }23\text{V}$	$-40^\circ\text{C to }85^\circ\text{C}$		$\pm 3.5$		$\mu\text{V}/^\circ\text{C}$
Power-Supply Rejection Ratio	PSRR	$V_S=5\text{V to }25\text{V}$	$25^\circ\text{C}$	83	106		dB
			$-40^\circ\text{C to }125^\circ\text{C}$	70			
<b>NOISE</b>							
Input Voltage Noise	$e_n$ p-p	$f=0.1\text{Hz to }10\text{Hz}$	$25^\circ\text{C}$		5.5		$\mu\text{V}_{PP}$
Input Voltage Noise Density	$e_n$	$f=10\text{Hz}$	$25^\circ\text{C}$		80		$\text{nV}/\sqrt{\text{Hz}}$
		$f=1\text{KHz}$			16		
		$f=10\text{KHz}$			14		
Input Current Noise Density	$I_n$	$f=0.1\text{Hz}$	$25^\circ\text{C}$		0.85		$\text{fA}/\sqrt{\text{Hz}}$
Total harmonic distortion + noise	THD+N	$A_V=1, f=1\text{kHz}, V_{IN}=4.5\text{V rms}$	$25^\circ\text{C}$		0.003		%
<b>INPUT VOLTAGE</b>							
Common-Mode Voltage Range	$V_{CM}$	$V_S=25\text{V}$	$-40^\circ\text{C to }125^\circ\text{C}$	0		23	V
Common-Mode Rejection Ratio	CMRR	$V_{CM}=1.5\text{V to }21\text{V}$	$25^\circ\text{C}$	95	120		dB
			$-40^\circ\text{C to }125^\circ\text{C}$	90			
		$V_{CM}=0\text{ to }23\text{V}$	$25^\circ\text{C}$	80	85		
<b>INPUT IMPEDANCE</b>							
Input Resistance	$R_{IN}$				$> 20$		$\text{T}\Omega$
Input Capacitance	$C_{IN}$				8		pF
<b>OPEN-LOOP GAIN</b>							
Open-Loop Voltage Gain	$A_{OL}$	$R_L=10\text{k}\Omega, V_{OUT}=0.5\text{V to }24.5\text{V}$	$25^\circ\text{C}$	110	130		dB
			$-40^\circ\text{C to }125^\circ\text{C}$	105			
<b>FREQUENCY RESPONSE</b>							
Unity gain bandwidth	GBW	$V_{IN}=50\text{mV rms}, R_L=10\text{k}\Omega, C_L=10\text{pF}, A_V=11$	$25^\circ\text{C}$		3.3		MHz
Unity-Gain Crossover	UGC	$V_{IN}=50\text{mV rms}, R_L=10\text{k}\Omega, C_L=10\text{pF}, A_{VO}=1$	$25^\circ\text{C}$		3.3		MHz
Slew Rate <sup>(8)</sup>	SR	$R_L=10\text{k}\Omega, C_L=10\text{pF}, A_V=1$	$25^\circ\text{C}$		2.1		$\text{V}/\mu\text{s}$
Settling Time	$t_s$	$V_{IN}=2\text{V step}, R_L=10\text{k}\Omega, C_L=10\text{pF}, A_V=-1$	$25^\circ\text{C}$		2.0		$\mu\text{s}$
Overload Recovery Time	$t_{OR}$	$V_{IN} \times G \geq V_S, G=-10$	$25^\circ\text{C}$		1.0		$\mu\text{s}$
-3dB Closed-Loop Bandwidth	$f_{-3dB}$	$V_{IN}=20\text{mV rms}, R_L=10\text{k}\Omega, C_L=10\text{pF}, A_V=1$	$25^\circ\text{C}$		6		MHz
Phase Margin	$\Phi_M$	$V_{IN}=10\text{mV rms}, R_L=10\text{k}\Omega, C_L=10\text{pF}, A_{VO}=1$	$25^\circ\text{C}$		60		degree

## ELECTRICAL CHARACTERISTICS (Continued)

(At  $T_A=+25^\circ\text{C}$ ,  $V_S=25\text{V}$ ,  $V_{CM}=V_{OUT}=V_S/2$ , and  $R_L=10\text{k}\Omega$  connected to  $V_S/2$ , Full =  $-40^\circ\text{C}$  to  $+125^\circ\text{C}$ , unless otherwise noted.)<sup>(1)</sup>

PARAMETER	SYMBOL	CONDITION	TEMP	MIN <sup>(2)</sup>	TYP <sup>(3)</sup>	MAX <sup>(2)</sup>	UNIT	
<b>OUTPUT</b>								
Output Voltage	$V_{OH}$	$R_L=2\text{K}\Omega$	25°C		24.62		V	
			-40°C to 125°C	24.5				
		$R_L=10\text{K}\Omega$	25°C	24.8	24.92			
			-40°C to 125°C	24.75				
	$V_{OL}$	$R_L=2\text{K}\Omega$	25°C		0.61		V	
			-40°C to 125°C			0.75		
$R_L=10\text{K}\Omega$		25°C		0.13	0.2			
		-40°C to 125°C			0.22			
Output Source Current <sup>(6) (7)</sup>	$I_{SOURCE}$		25°C		70		mA	
Output Sink Current <sup>(6) (7)</sup>	$I_{SINK}$				-50			
Closed-loop Output Impedance	$Z_O$	$f = 1\text{MHz}$ , $A_V=1$	25°C		40		$\Omega$	
<b>POWER SUPPLY</b>								
Quiescent Current Per Amplifier	$I_Q$	$I_{OUT}=0\text{A}$	25°C		1.1	2.0	mA	
			-40°C to 125°C			2.2		
<b>INTERNAL GUARD BUFFER</b>								
Guard Offset Voltage	$V_{GOS}$	$V_{CM}=1.5\text{V}$ to 23V	25°C		$\pm 80$	$\pm 400$	$\mu\text{V}$	
		$V_{CM}=1.5\text{V}$ to 23V	-40°C to 125°C			$\pm 1000$		
		$V_{CM}=0.1$ to 23V	25°C		$\pm 80$	$\pm 500$		
Guard Offset Voltage Drift	$\Delta V_{GOS}/\Delta T$		-40°C to 125°C		2.6		$\mu\text{V}/^\circ\text{C}$	
Output Impedance	$Z_{GOUT}$		25°C		1		$\text{k}\Omega$	
Output Voltage Range		$V_{GOS} < \pm 500\mu\text{V}$	25°C	0.1		23.5	V	
-3dB Bandwidth	$f_{-3\text{dBGUARD}}$		25°C		3		MHz	

**NOTE:**

- (1) Electrical table values apply only for factory testing conditions at the temperature indicated. Factory testing conditions result in very limited self-heating of the device.
- (2) Limits are 100% production tested at 25°C. Limits over the operating temperature range are ensured through correlations using statistical quality control (SQC) method.
- (3) Typical values represent the most likely parametric norm as determined at the time of characterization. Actual typical values may vary over time and will also depend on the application and configuration.
- (4) This parameter is ensured by design and/or characterization and is not tested in production.
- (5) Positive current corresponds to current flowing into the device.
- (6) The maximum power dissipation is a function of  $T_{J(\text{MAX})}$ ,  $R_{\theta JA}$ , and  $T_A$ . The maximum allowable power dissipation at any ambient temperature is  $P_D = (T_{J(\text{MAX})} - T_A) / R_{\theta JA}$ . All numbers apply for packages soldered directly onto a PCB.
- (7) Short circuit test is a momentary test.
- (8) Number specified is the slower of positive and negative slew rates.

## 7.5 TYPICAL CHARACTERISTICS

NOTE: The graphs and tables provided following this note are a statistical summary based on a limited number of samples and are provided for informational purposes only.

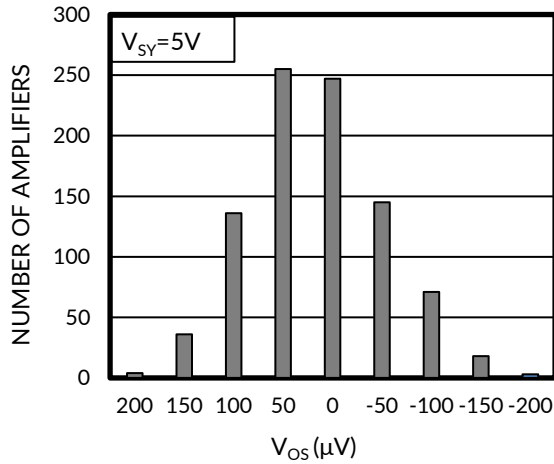

**Figure 1. Input Offset Voltage Distribution**

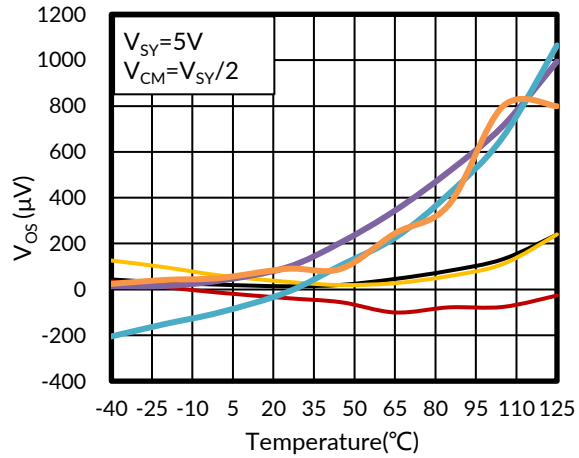

**Figure 2. Input Offset Voltage ( $V_{OS}$ ) vs Temperature**

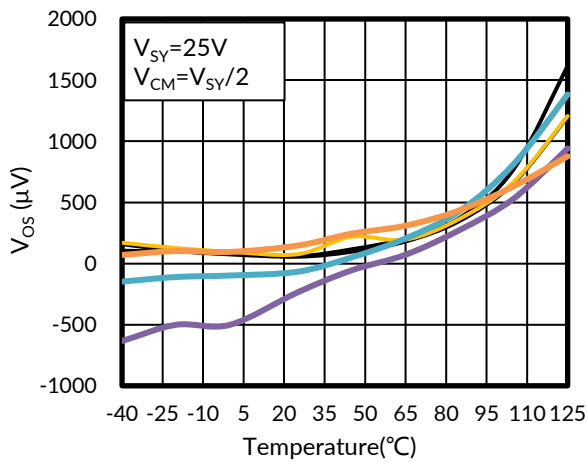

**Figure 3. Input Offset Voltage ( $V_{OS}$ ) vs Temperature**

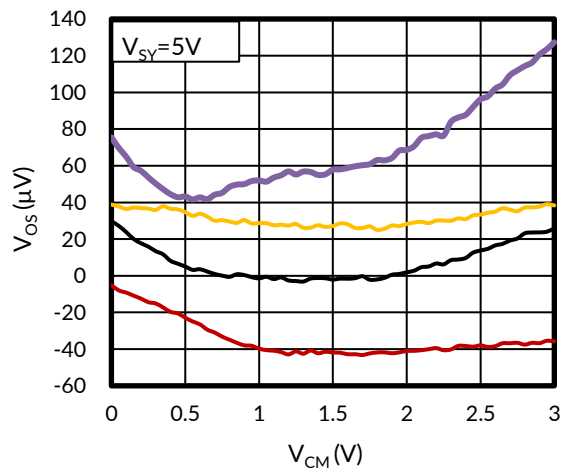

**Figure 4. Input Offset Voltage ( $V_{OS}$ ) vs Common-Mode Voltage ( $V_{CM}$ )**

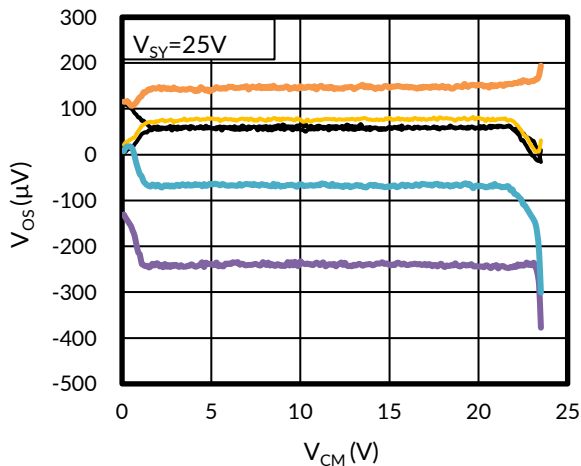

**Figure 5. Input Offset Voltage ( $V_{OS}$ ) vs Common-Mode Voltage ( $V_{CM}$ )**

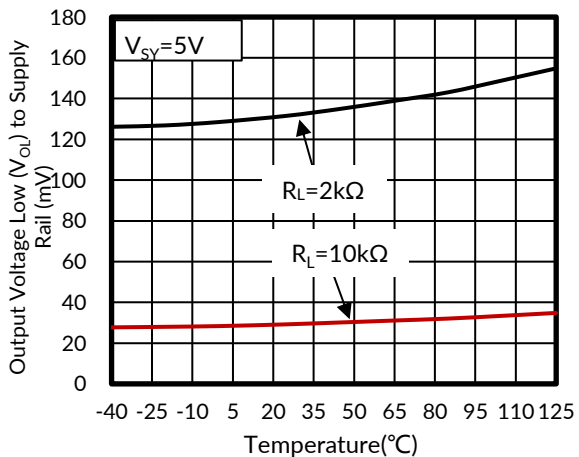

**Figure 6. Output Voltage Low ( $V_{OL}$ ) to Supply Rail vs Temperature**

## TYPICAL CHARACTERISTICS

NOTE: The graphs and tables provided following this note are a statistical summary based on a limited number of samples and are provided for informational purposes only.

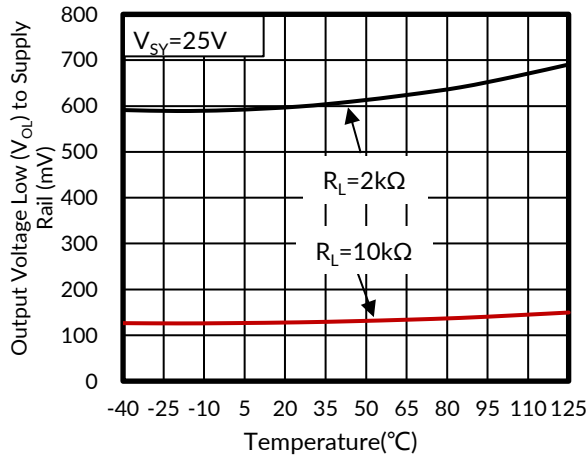

**Figure 7. Output Voltage Low ( $V_{OL}$ ) to Supply Rail vs Temperature**

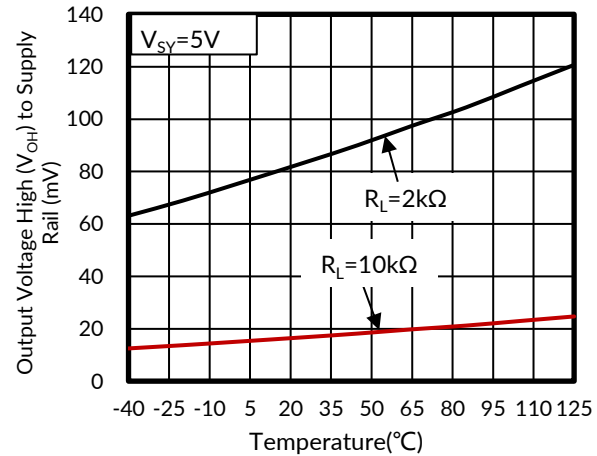

**Figure 8. Output Voltage High ( $V_{OH}$ ) to Supply Rail vs Temperature**

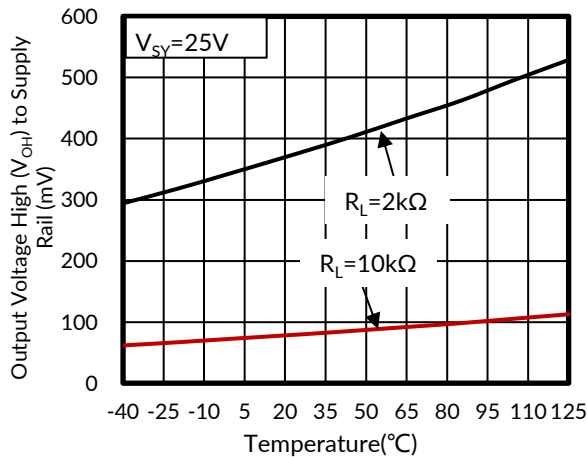

**Figure 9. Output Voltage High ( $V_{OH}$ ) to Supply Rail vs Temperature**

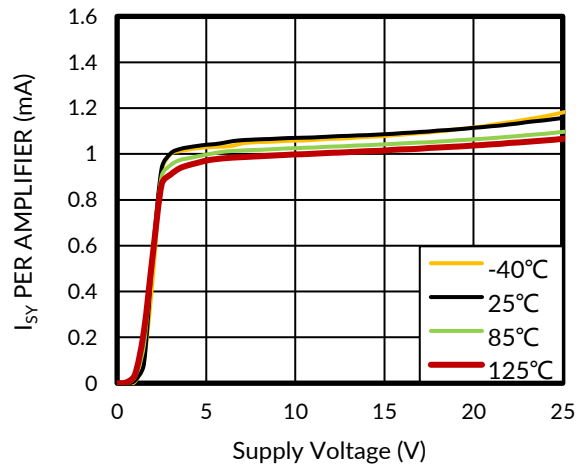

**Figure 10. Supply Current ( $I_{SY}$ ) per Amplifier vs Supply Voltage ( $V_{SY}$ )**

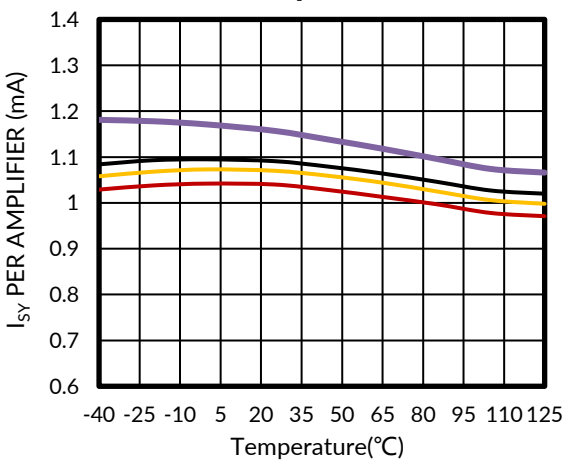

**Figure 11. Supply Current ( $I_{SY}$ ) per Amplifier vs Temperature**

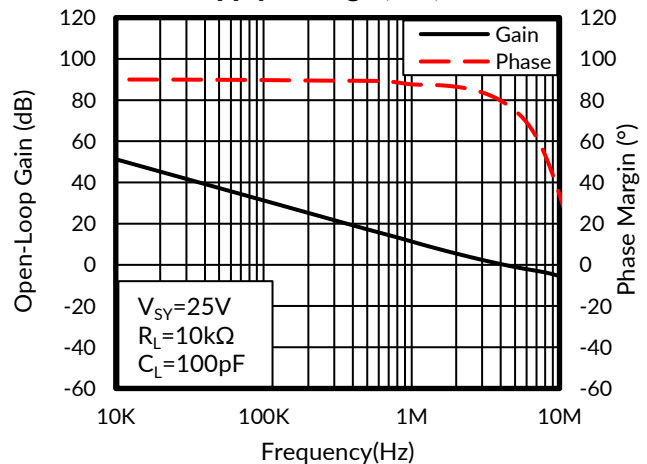

**Figure 12. Open-Loop Gain and Phase Margin vs Frequency**

## TYPICAL CHARACTERISTICS

NOTE: The graphs and tables provided following this note are a statistical summary based on a limited number of samples and are provided for informational purposes only.

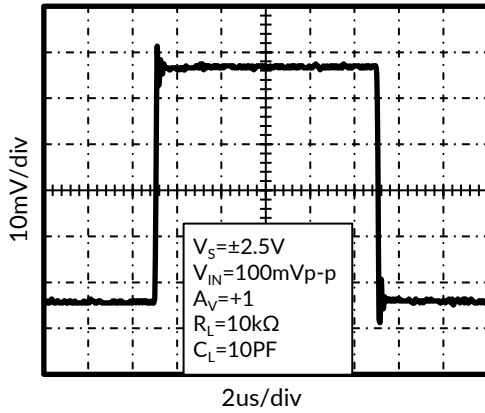

**Figure 13. Small-Signal Step Response**

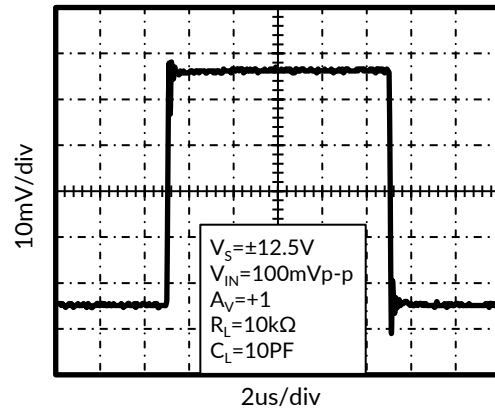

**Figure 14. Small-Signal Step Response**

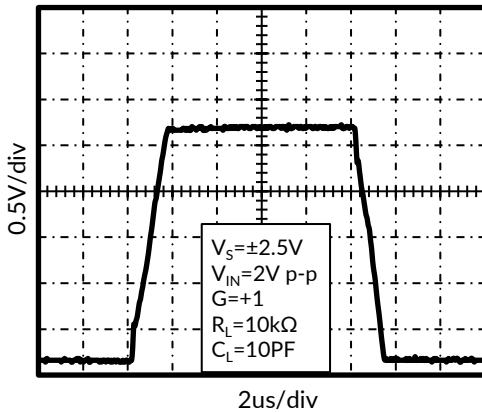

**Figure 15. Large-Signal Step Response**

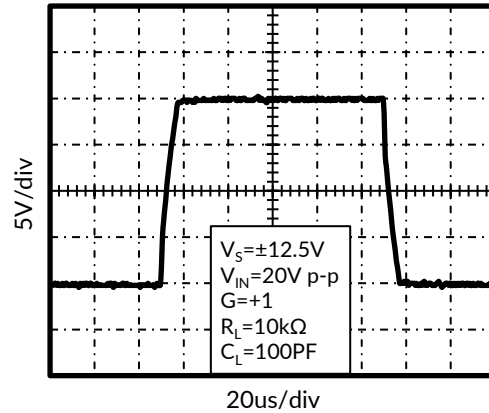

**Figure 16. Large-Signal Step Response**

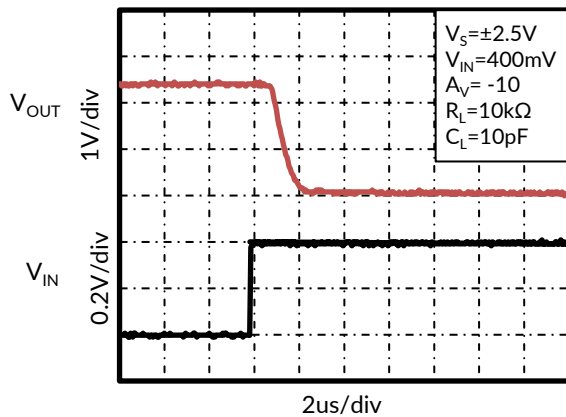

**Figure 17. Positive Overload Recovery**

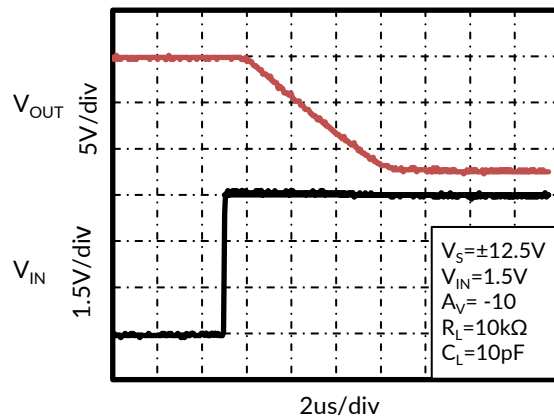

**Figure 18. Positive Overload Recovery**

## TYPICAL CHARACTERISTICS

NOTE: The graphs and tables provided following this note are a statistical summary based on a limited number of samples and are provided for informational purposes only.

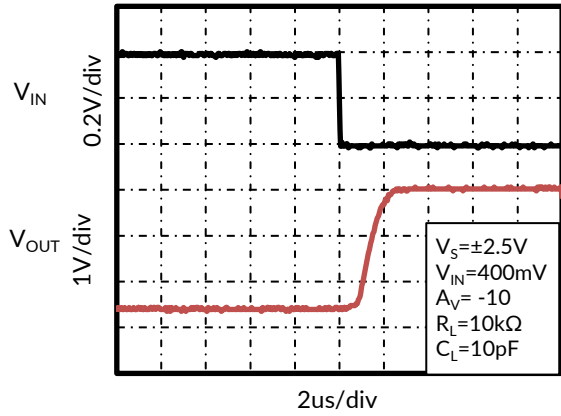

Figure 19. Negative Overload Recovery

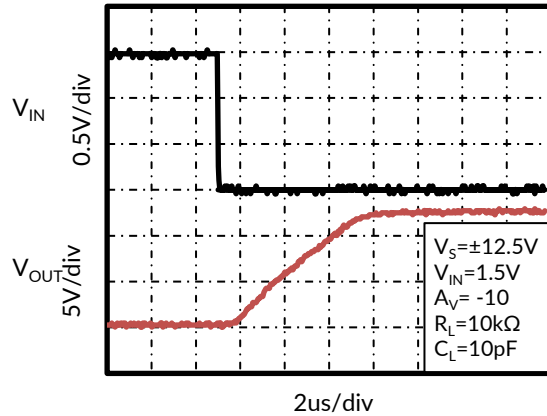

Figure 20. Negative Overload Recovery

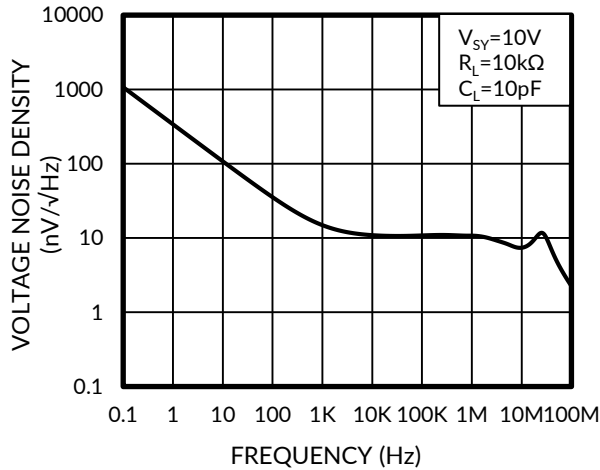

Figure 21. Voltage Noise Density vs Frequency

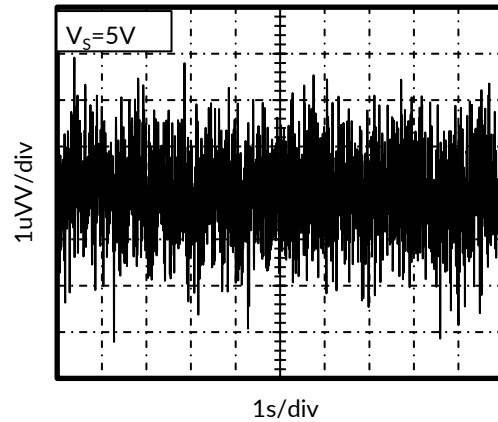
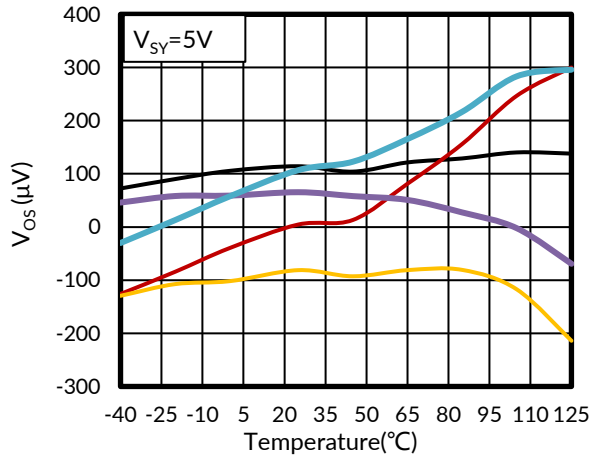

Figure 22. 0.1Hz to 10Hz Input Voltage Noise

## GUARD AMPLIFIER

NOTE: The graphs and tables provided following this note are a statistical summary based on a limited number of samples and are provided for informational purposes only.



**Figure 23. Input Offset Voltage ( $V_{OS}$ ) vs Temperature**

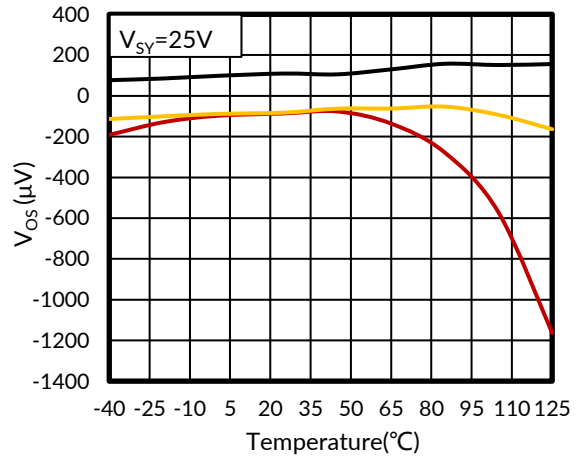

**Figure 24. Input Offset Voltage ( $V_{OS}$ ) vs Temperature**

## 8 Application and Implementation

Information in the following applications sections is not part of the Runic component specification, and Runic does not warrant its accuracy or completeness. Runic's customers are responsible for determining suitability of components for their purposes. Customers should validate and test their design implementation to confirm system functionality.

### 8.1 ESD STRUCTURE

The input ESD structure consists of Diode D1 to Diode D6. The noninverting input is coupled to the guard pins (GRD) by the D1 and D2 antiparallel diodes. The inverting input is coupled to the guard pins by the D3 and D4 antiparallel diodes.

The guard pins are connected to the power supplies through Diode D5 and Diode D6. During ESD events, the transient current flows from the input pins through one of the antiparallel diodes and harmlessly into the supplies through one of the power supply diodes. During normal operation, the guard buffer (BUF1) forces the voltage across the antiparallel diodes to 0V. Resistor R1 shields the guard buffer from potentially large capacitances connected to the guard pins. Its value is nominally 1k $\Omega$ .

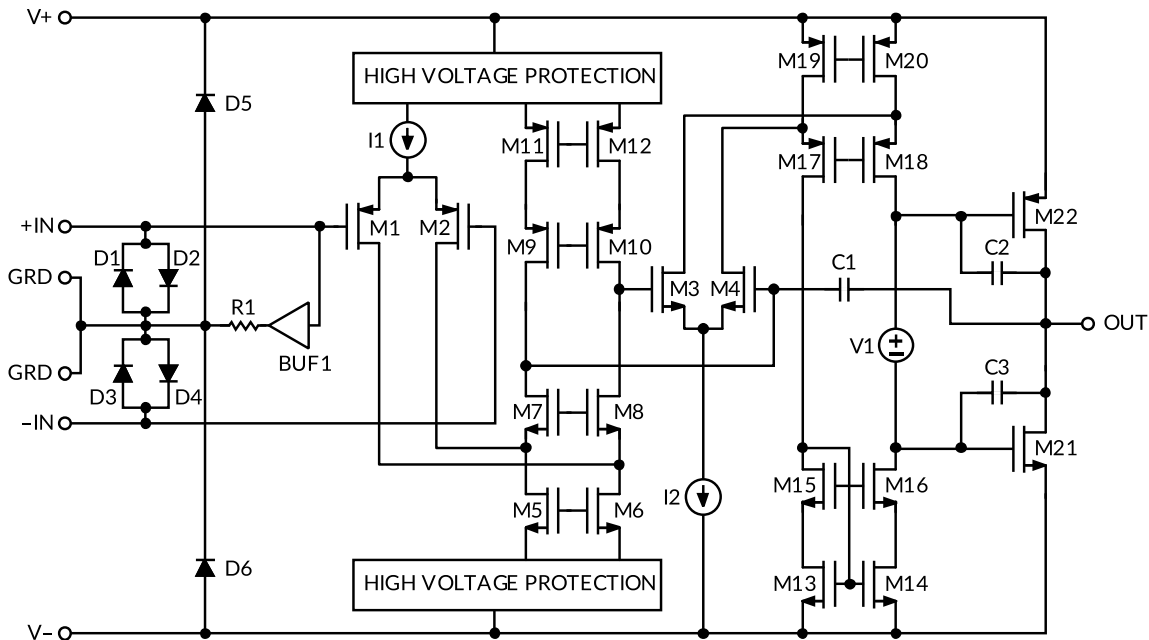

**Figure 25. Simplified Schematic**

### 8.2 GUARD BUFFER

The guard buffer (BUF1) is a unity-gain amplifier that creates a low impedance replica of the input common-mode voltage. The buffer input is connected to the noninverting input (IN+). The noninverting input voltage is approximately equal to the input common-mode voltage when the main amplifier feedback loop is settled.



## 9 PACKAGE OUTLINE DIMENSIONS

### SOIC-8(SOP8) <sup>(4)</sup>

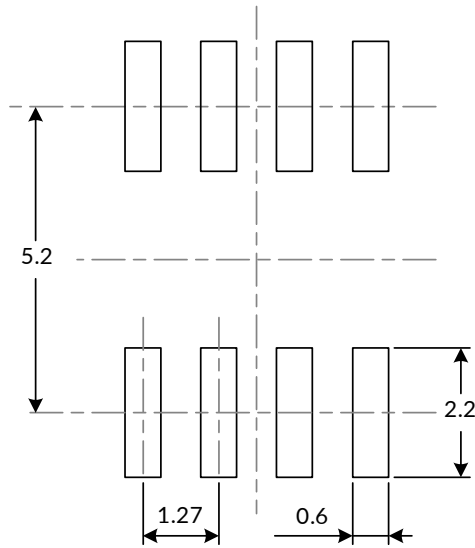
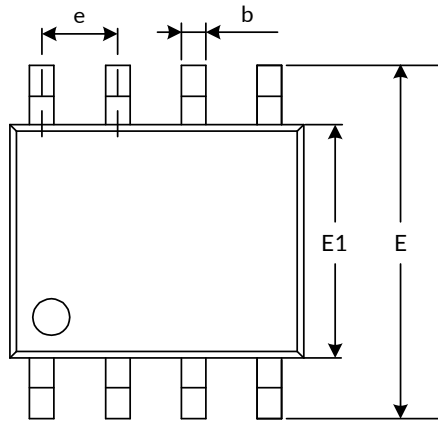

RECOMMENDED LAND PATTERN (Unit: mm)

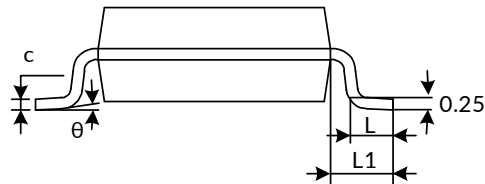
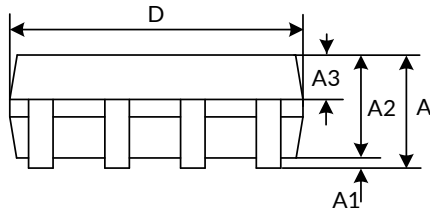

Symbol	Dimensions In Millimeters		Dimensions In Inches	
	Min	Max	Min	Max
A <sup>(1)</sup>		1.750		0.069
A1	0.100	0.250	0.004	0.010
A2	1.250	1.500	0.049	0.059
A3	0.600	0.700	0.024	0.028
b	0.360	0.490	0.014	0.019
c	0.190	0.250	0.007	0.010
D <sup>(1)</sup>	4.800	5.000	0.189	0.197
E1 <sup>(1)</sup>	3.800	4.000	0.150	0.157
E	5.800	6.200	0.228	0.244
e	1.270 (BSC) <sup>(2)</sup>		0.050 (BSC) <sup>(2)</sup>	
L	0.400	1.000	0.016	0.039
L1	1.050 (REF) <sup>(3)</sup>		0.041 (REF) <sup>(3)</sup>	
theta	0°	8°	0°	8°

NOTE:

1. Plastic or metal protrusions of 0.15mm maximum per side are not included.
2. BSC (Basic Spacing between Centers), "Basic" spacing is nominal.
3. REF is the abbreviation for Reference.
4. This drawing is subject to change without notice.

# 10 TAPE AND REEL INFORMATION

## REEL DIMENSIONS

## TAPE DIMENSION

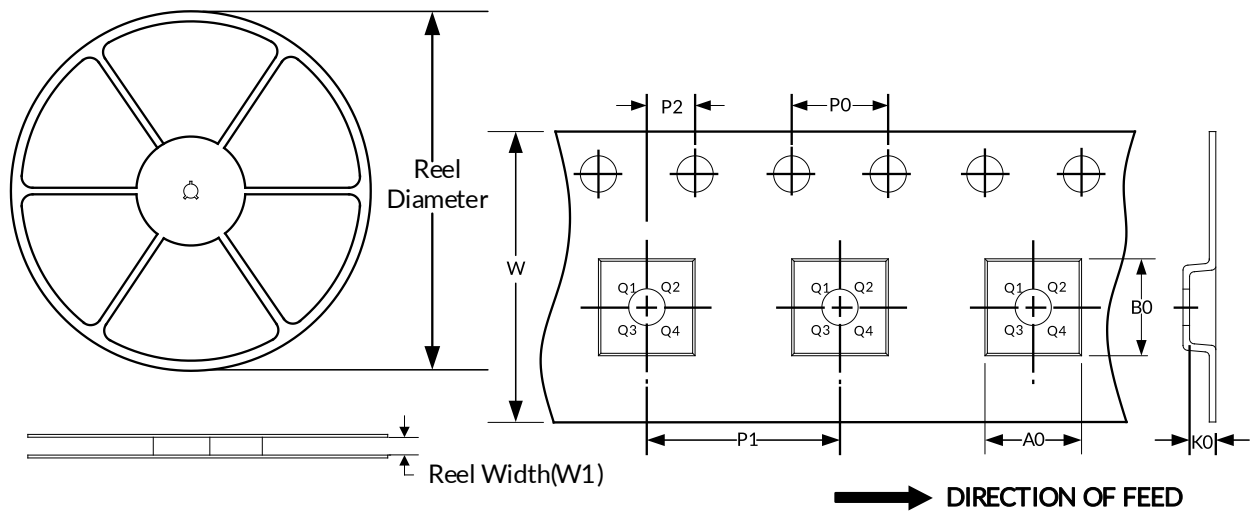

NOTE: The picture is only for reference. Please make the object as the standard.

### KEY PARAMETER LIST OF TAPE AND REEL

Package Type	Reel Diameter	Reel Width (mm)	A0 (mm)	B0 (mm)	K0 (mm)	P0 (mm)	P1 (mm)	P2 (mm)	W (mm)	Pin1 Quadrant
SOIC-8(SOP8)	13"	12.4	6.40	5.40	2.10	4.0	8.0	2.0	12.0	Q1

NOTE:

1. All dimensions are nominal.
2. Plastic or metal protrusions of 0.15mm maximum per side are not included.

## **IMPORTANT NOTICE AND DISCLAIMER**

Jiangsu Runic Technology Co., Ltd. will accurately and reliably provide technical and reliability data (including data sheets), design resources (including reference designs), application or other design advice, WEB tools, safety information and other resources, without warranty of any defect, and will not make any express or implied warranty, including but not limited to the warranty of merchantability Implied warranty that it is suitable for a specific purpose or does not infringe the intellectual property rights of any third party.

These resources are intended for skilled developers designing with Runic products You will be solely responsible for: (1) Selecting the appropriate products for your application; (2) Designing, validating and testing your application; (3) Ensuring your application meets applicable standards and any other safety, security or other requirements; (4) Runic and the Runic logo are registered trademarks of Runic Incorporated. All trademarks are the property of their respective owners; (5) For change details, review the revision history included in any revised document. The resources are subject to change without notice. Our company will not be liable for the use of this product and the infringement of patents or third-party intellectual property rights due to its use.