

# MSKSEMI 美森科

SEMICONDUCTOR



ESD



TVS



TSS

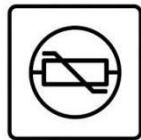

MOV



GDT



PLED

## L7809CV(MS)



Product specification

**Three-terminal positive voltage regulator**

**FEATURES**

- Maximum Output current IOM : 1.5A
- Output voltage Vo: 9V
- Continuous total dissipation  
 $P_D$ : 1.5 W ( $T_a = 25\text{ }^\circ\text{C}$ )  
 15 W( $T_c = 25\text{ }^\circ\text{C}$ )

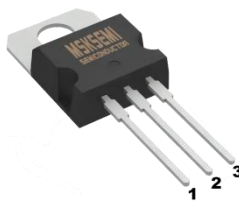
**Reference News**

PACKAGE OUTLINE	Marking
 <p>1.IN 2.GND 3.OUT</p>	

**ABSOLUTE MAXIMUM RATINGS (Operating temperature range applies unless otherwise specified)**

Parameter	Symbol	Value	Unit
Input Voltage	$V_i$	35	V
Thermal Resistance from Junction to Ambient	$R_{\theta JA}$	83.3	$^\circ\text{C/W}$
Thermal Resistance from Junction to Case	$R_{\theta JC}$	8.3	$^\circ\text{C/W}$
Operating Junction Temperature Range	$T_{OPR}$	0~+150	$^\circ\text{C}$
Storage Temperature Range	$T_{STG}$	-55~+150	$^\circ\text{C}$

**ELECTRICAL CHARACTERISTICS AT SPECIFIED VIRTUAL JUNCTION TEMPERATURE**

( $V_i=16\text{V}$ ,  $I_o=500\text{mA}$ ,  $C_i=0.33\mu\text{F}$ ,  $C_o=0.1\mu\text{F}$ , unless otherwise specified)

Parameter	Symbol	Test conditions	MIN	TYP	MAX	UNIT	
Output voltage	$V_o$		25 $^\circ\text{C}$	8.65	9	9.35	V
		$11.5\text{V} \leq V_i \leq 24\text{V}$ , $I_o = 5\text{mA} - 1\text{A}$ , $P \leq 15\text{W}$	0-125 $^\circ\text{C}$	8.55	9	9.45	V
Load Regulation	$\Delta V_o$	$I_o = 5\text{mA} - 1.5\text{A}$	25 $^\circ\text{C}$		12	180	mV
		$I_o = 250\text{mA} - 750\text{mA}$	25 $^\circ\text{C}$		4	90	mV
Line regulation	$\Delta V_o$	$11.5\text{V} \leq V_i \leq 27\text{V}$	25 $^\circ\text{C}$		7	180	mV
		$13\text{V} \leq V_i \leq 19\text{V}$	25 $^\circ\text{C}$		2	90	mV
Quiescent Current	$I_q$		25 $^\circ\text{C}$		4.3	8	mA
Quiescent Current Change	$\Delta I_q$	$11.5\text{V} \leq V_i \leq 27\text{V}$	0-125 $^\circ\text{C}$			1	mA
		$5\text{mA} \leq I_o \leq 1\text{A}$	0-125 $^\circ\text{C}$			0.5	mA
Output voltage drift	$\Delta V_o / \Delta T$	$I_o = 5\text{mA}$	0-125 $^\circ\text{C}$		-1		mV/ $^\circ\text{C}$
Output Noise Voltage	$V_N$	$10\text{Hz} \leq f \leq 100\text{KHz}$	25 $^\circ\text{C}$		60		$\mu\text{V}$
Ripple Rejection	RR	$12\text{V} \leq V_i \leq 22\text{V}$ , $f = 120\text{Hz}$	0-125 $^\circ\text{C}$	55	70		dB
Dropout Voltage	$V_d$	$I_o = 1\text{A}$	25 $^\circ\text{C}$		2		V
Output resistance	$R_o$	$f = 1\text{KHz}$	25 $^\circ\text{C}$		18		m $\Omega$
Short Circuit Current	$I_{sc}$		25 $^\circ\text{C}$		400		mA
Peak Current	$I_{pk}$		25 $^\circ\text{C}$		2.0		A

**TYPICAL APPLICATION**

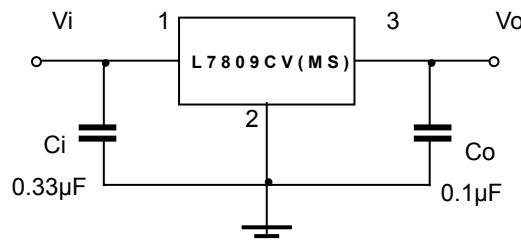

Typical Characteristics

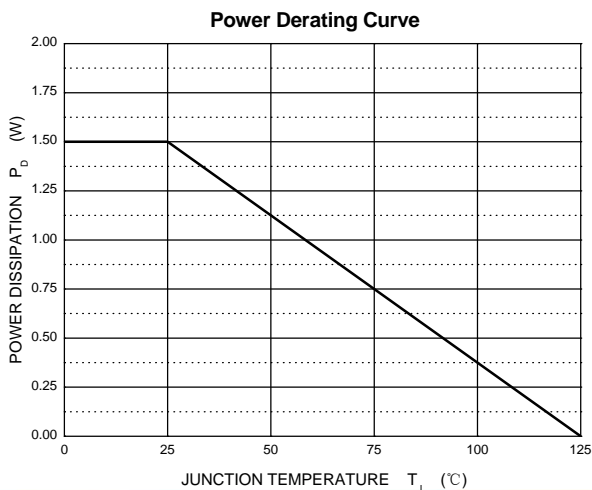
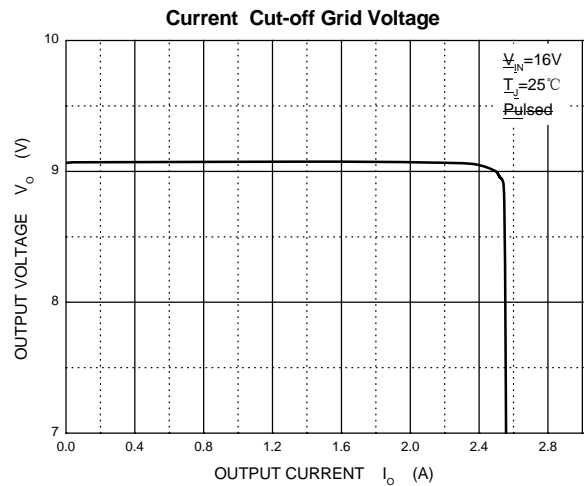
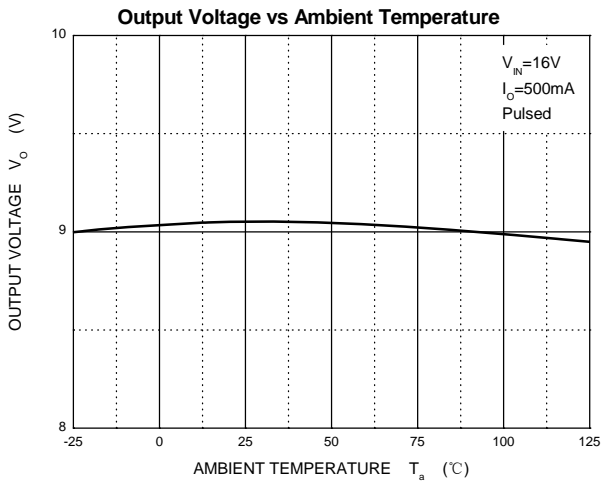
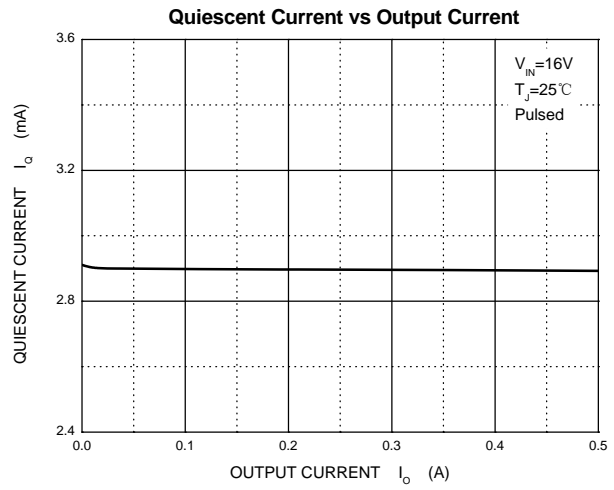
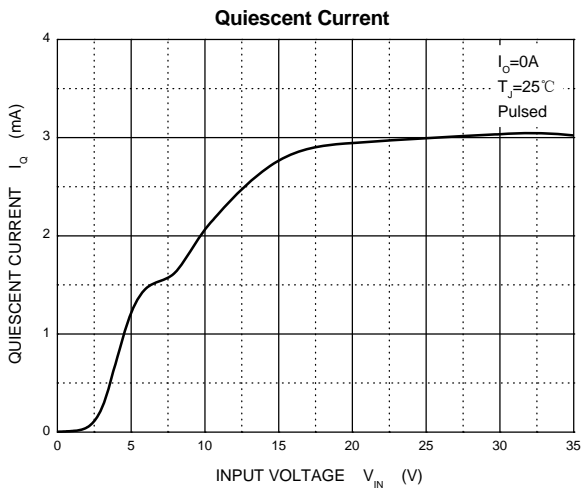
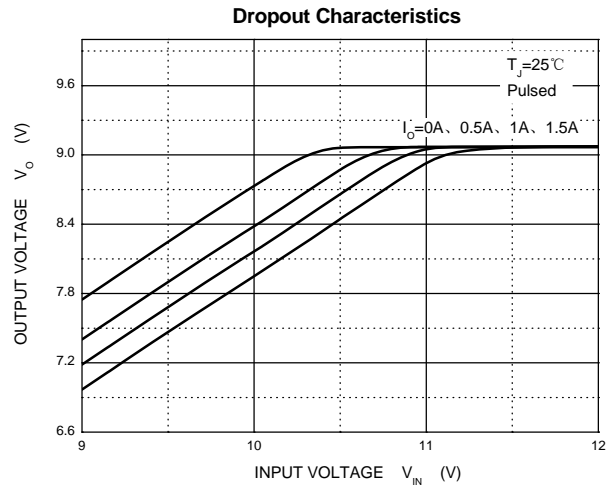
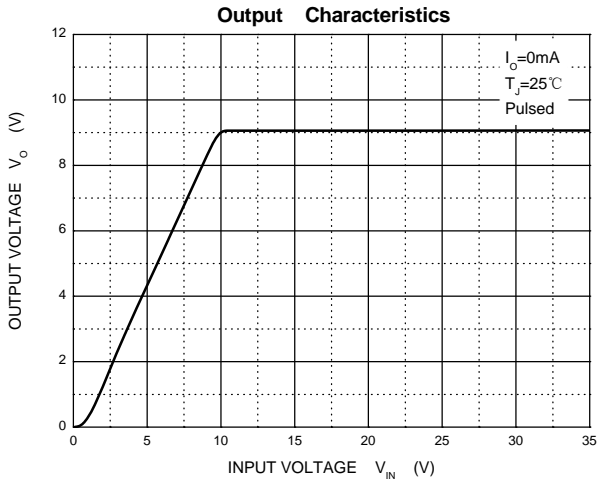

Package mechanical data

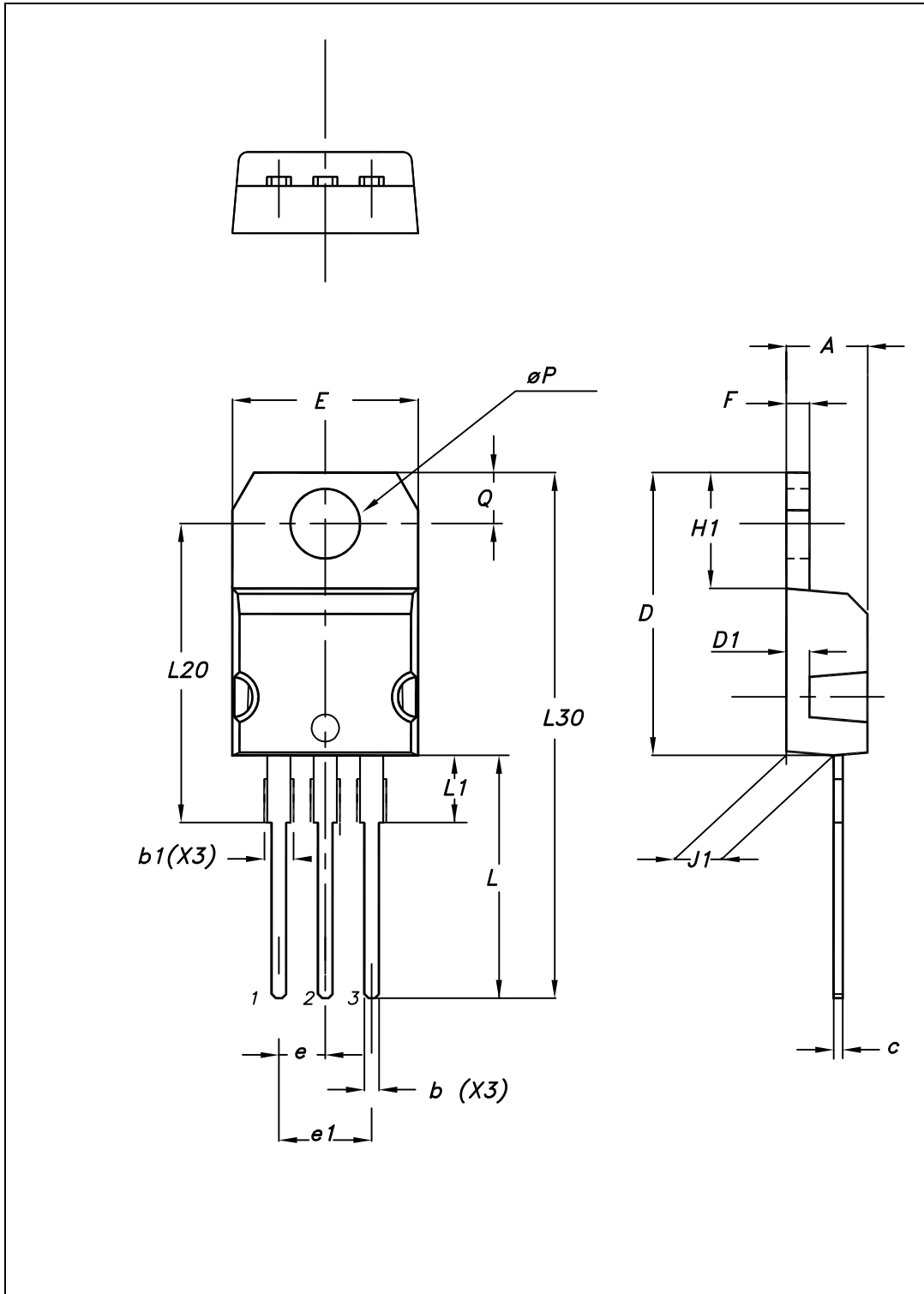

**Package mechanical data**

Dim.	mm		
	Min.	Typ.	Max.
A	4.40		4.60
b	0.61		0.88
b1	1.14		1.70
c	0.48		0.70
D	15.25		15.75
D1		1.27	
E	10		10.40
e	2.40		2.70
e1	4.95		5.15
F	1.23		1.32
H1	6.20		6.60
J1	2.40		2.72
L	13		14
L1	3.50		3.93
L20		16.40	
L30		28.90	
ØP	3.75		3.85
Q	2.65		2.95

**REEL SPECIFICATION**

P/N	PKG	QTY
L7809CV(MS)	TO-220	50/One tube 1000/a box of

## Attention

- Any and all MSKSEMI Semiconductor products described or contained herein do not have specifications that can handle applications that require extremely high levels of reliability, such as life-support systems, aircraft's control systems, or other applications whose failure can be reasonably expected to result in serious physical and/or material damage. Consult with your MSKSEMI Semiconductor representative nearest you before using any MSKSEMI Semiconductor products described or contained herein in such applications.
- MSKSEMI Semiconductor assumes no responsibility for equipment failures that result from using products at values that exceed, even momentarily, rated values (such as maximum ratings, operating condition ranges, or other parameters) listed in products specifications of any and all MSKSEMI Semiconductor products described or contained herein.
- Specifications of any and all MSKSEMI Semiconductor products described or contained herein stipulate the performance, characteristics, and functions of the described products in the independent state, and are not guarantees of the performance, characteristics, and functions of the described products as mounted in the customer's products or equipment. To verify symptoms and states that cannot be evaluated in an independent device, the customer should always evaluate and test devices mounted in the customer's products or equipment.
- MSKSEMI Semiconductor strives to supply high-quality high-reliability products. However, any and all semiconductor products fail with some probability. It is possible that these probabilistic failures could give rise to accidents or events that could endanger human lives, that could give rise to smoke or fire, or that could cause damage to other property. When designing equipment, adopt safety measures so that these kinds of accidents or events cannot occur. Such measures include but are not limited to protective circuits and error prevention circuits for safe design, redundant design, and structural design.
- In the event that any or all MSKSEMI Semiconductor products (including technical data, services) described or contained herein are controlled under any of applicable local export control laws and regulations, such products must not be exported without obtaining the export license from the authorities concerned in accordance with the above law.
- No part of this publication may be reproduced or transmitted in any form or by any means, electronic or mechanical, including photocopying and recording, or any information storage or retrieval system, or otherwise, without the prior written permission of MSKSEMI Semiconductor.
- Information (including circuit diagrams and circuit parameters) herein is for example only ; it is not guaranteed for volume production. MSKSEMI Semiconductor believes information herein is accurate and reliable, but no guarantees are made or implied regarding its use or any infringements of intellectual property rights or other rights of third parties.
- Any and all information described or contained herein are subject to change without notice due to product/technology improvement, etc. When designing equipment, refer to the "Delivery Specification" for the MSKSEMI Semiconductor product that you intend to use.