

7.5 kW, Unidirectional and Bidirectional TVS Protection Device

MPLAD7.5KP10A(e3) – MPLAD7.5KP48CA(e3)



Description

These 7.5 kW rated transient voltage suppressors (TVS) in a surface mount PLAD package are provided with design features to minimize thermal resistance and cumulative heating. These devices have the ability to clamp dangerous high voltage, short term transients such as those produced by electrostatic discharge, radiated RFI, inductive load dumps, and the secondary effects of lightning strikes before they reach sensitive component regions of a circuit. Typical applications include lightning and automotive load dump protection. They are particularly effective at meeting the multi-stroke lightning standard RTCA DO-160, section 22 for aircraft design. The all-metal bottom of this space-efficient, low profile package provides a very low thermal impedance path for heat to escape to the mounting substrate, keeping the junction temperature low. The PLAD7.5KP is offered with stand-off voltages (V_{WM}) from 10 to 48 volts in either unidirectional or bidirectional versions. High-reliability screening is available in reference to MIL-PRF-19500, and the product is tested in accordance with the requirements of AEC-Q101. For more information on PLAD packaged products and our broad range of TVS solutions, please see our website.

Features

- Available in both unidirectional and bidirectional construction (bidirectional with CA suffix)
- High-reliable, with wafer fabrication and assembly lot traceability
- All parts 100% surge tested
- Low profile surface-mount package
- Optional up-screening is available with various screening and conformance inspection options based on MIL-PRF-19500. Refer to the [Hi-Rel Non-Hermetic Products](#) brochure on our web site for more details on the screening options.
- Suppresses transients up to 7,500W at 10/1000 μ s (see [Figure 4-1](#))
- Moisture classification is level 1 with no dry pack required per IPC/JEDEC J-STD-020
- 3σ lot norm screening performed on standby current (I_D)
- RoHS compliant (2002/95/EC) devices available
- Halogen free (IEC 61249-2-21)

Figure 1. mini-Plad

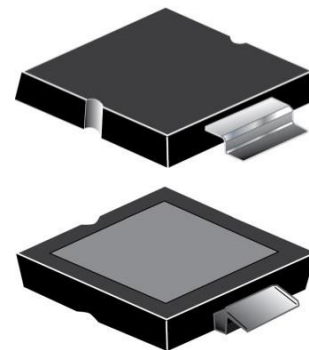

The cathode is the heat sink under the body of this device.

Applications/Benefits

- Protection from switching transients and induced RF
- Protection from ESD and EFT per IEC 61000-4-2 and IEC 61000-4-4
- Secondary lightning protection per IEC 61000-4-5 with 42 ohms source impedance:
Class 1, 2, 3, 4, 5: MPLAD7.5KP10A to 48CA
- Secondary lightning protection per IEC 61000-4-5 with 12 ohms source impedance:
Class 1, 2, 3, 4: MPLAD7.5KP10A to 48CA
- Secondary lightning protection per IEC 61000-4-5 with 2 ohms source impedance:
Class 2, 3: MPLAD7.5KP10A to 48CA
Class 4: MPLAD7.5KP10A to 26CA
- Pin injection protection per RTCA/DO-160G for Waveform 4 (6.4/69 μ s at 25 °C)¹:
Level 1, 2, 3, 4, 5: MPLAD7.5KP10A to 48CA
- Pin injection protection per RTCA/DO-160G for Waveform 5A (40/120 μ s at 25 °C)¹:
Level 1, 2, 3: MPLAD7.5KP10A to 48CA
Level 4: MPLAD7.5KP10A to 14CA
- Longer transient pulse width capability if well heat sunk for automotive load dump
- I_{PP} rating of 97 amps to 441 amps
- V_{WM} rating of 10 volts to 48 volts
- $V_{(BR)(Min)}$ range of 11.1 volts to 53.3 volts
- $V_{C(Max)}$ rating of 17 volts to 77.4 volts

Note:

1. See [MicroNote 132](#) for further temperature derating selection.

Table of Contents

Description.....	1
1. Absolute Maximum Ratings.....	4
1.1. Mechanical and Packaging.....	4
2. Part Nomenclature.....	5
2.1. Symbols and Definitions.....	5
3. Electrical Characteristics.....	6
4. Graphs.....	7
5. Package Dimensions.....	9
5.1. Pad Layout.....	9
6. Revision History.....	10
Microchip Information.....	11
The Microchip Website.....	11
Product Change Notification Service.....	11
Customer Support.....	11
Microchip Devices Code Protection Feature.....	11
Legal Notice.....	11
Trademarks.....	12
Quality Management System.....	13
Worldwide Sales and Service.....	14

1. Absolute Maximum Ratings

Table 1-1. Absolute Maximum Ratings at 25 °C Unless Otherwise Specified

Parameters/Test Conditions	Symbol	Value	Unit	
Junction and storage temperature	T_J and T_{STG}	-55 to +150	°C/W	
Thermal resistance junction-to-ambient ¹	$R_{\theta JA}$	50	°C/W	
Thermal resistance junction-to-case	$R_{\theta JC}$	1.5	°C/W	
Peak pulse power at 10/1000 μs^2	P_{PP}	7,500	W	
$t_{clamping}$ (0 volts to $V_{(BR)}$ min)	Unidirectional	< 100	ps	
	Bidirectional	< 5	ns	
Forward clamping voltage at 400 amps ³	V_{FS}	2.5	V	
Forward surge current ³	I_{FSM}	500	A	
Solder temperature at 10 s	—	260	°C	
Rated average power dissipation ⁵	$P_{M(AV)}$	$T_A = 25\text{ °C}$	2.5 ¹	W
		$T_C = 100\text{ °C}$	33.3 ⁴	W

Notes:

1. When mounted on FR4 PC board with recommended mounting pad (see [Pad Layout](#))
2. Also see [Figure 4-1](#) and [Figure 4-2](#). With impulse repetition rate (duty factor) of 0.05% or less
3. At 8.3 ms half-sine wave (unidirectional devices only)
4. Case temperature controlled on heat sink as specified
5. See [MicroNote 134](#) for derating P_{PP} when also applying steady-state power

1.1 Mechanical and Packaging

- Case: Epoxy, meets UL94V-0
- Terminals: Tin/lead or matte-tin (fully RoHS compliant) plating
- Marking: Reliability level, part number, polarity symbol (unidirectional only), and date code
- Delivery option: Tape and reel (13 inch)
- See [Package Dimensions](#)

2. Part Nomenclature

Figure 2-1. Part Nomenclature

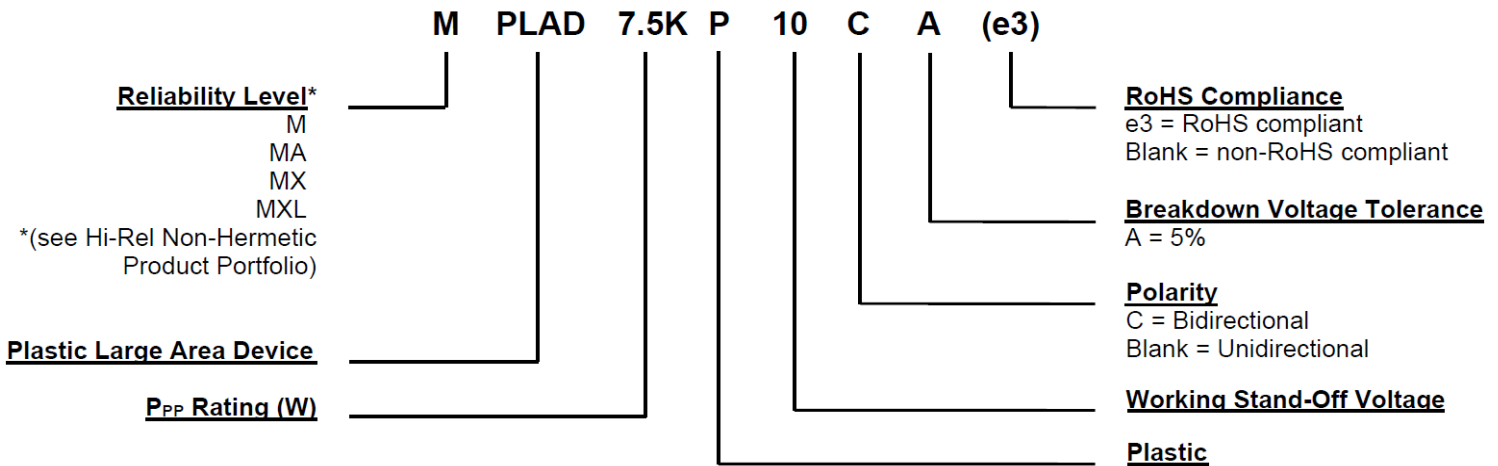

2.1 Symbols and Definitions

Table 2-1. Symbols and Definitions

Symbol	Definition
$\alpha_{V(BR)}$	Temperature coefficient of breakdown voltage: The change in breakdown voltage divided by the change in temperature that caused it expressed in %/°C or mV/°C.
$I_{(BR)}$	Breakdown current: The current used for measuring breakdown voltage $V_{(BR)}$.
I_D	Standby current: The current through the device at rated stand-off voltage.
I_{PP}	Peak impulse current: The maximum rated random recurring peak impulse current or nonrepetitive peak impulse current that may be applied to a device. A random recurring or nonrepetitive transient current is usually due to an external cause, and it is assumed that its effect will have completely disappeared before the next transient arrives.
P_{PP}	Peak pulse power: The peak power that can be applied for a specific pulse width and waveform. The product of V_C and I_{PP} .
$V_{(BR)}$	Breakdown voltage: The voltage across the device at a specified current $I_{(BR)}$ in the breakdown region.
V_C	Clamping voltage: The voltage across the device in a region of low differential resistance during the application of an impulse current (I_{PP}) for a specified waveform.
V_{WM}	Working stand-off voltage: The maximum-rated value of dc or repetitive peak positive cathode-to-anode voltage that may be continuously applied over the standard operating temperature.

3. Electrical Characteristics

Table 3-1. Electrical Characteristics at 25 °C Unless Otherwise Stated

Device ¹	Working Stand-Off Voltage V_{WM}	Breakdown Voltage $V_{(BR)}$ $V_{(BR)}$ at $I_{(BR)}$		Maximum Clamping Voltage V_C at I_{PP}	Maximum Standby Current I_D at V_{WM}	Maximum Peak Pulse Current (Figure 4-2) I_{PP}	Maximum Temperature Coefficient of $V_{(BR)}$ $\alpha_{V(BR)}$
	Volts	Volts	mA	Volts	μA	Amps	mV/°C
MPLAD7.5KP10(C)A(e3)	10	11.1-12.3	5	17.0	15	441	9
MPLAD7.5KP11(C)A(e3)	11	12.2-13.5	5	18.2	10	412	10
MPLAD7.5KP12(C)A(e3)	12	13.3-14.7	5	19.9	10	377	11
MPLAD7.5KP13(C)A(e3)	13	14.4-15.9	5	21.5	10	349	12
MPLAD7.5KP14(C)A(e3)	14	15.6-17.2	5	23.2	10	323	13
MPLAD7.5KP15(C)A(e3)	15	16.7-18.5	5	24.4	10	307	15
MPLAD7.5KP16(C)A(e3)	16	17.8-19.7	5	26.0	10	288	16
MPLAD7.5KP17(C)A(e3)	17	18.9-20.9	5	27.6	10	272	18
MPLAD7.5KP18(C)A(e3)	18	20.0-22.1	5	29.2	10	257	19
MPLAD7.5KP20(C)A(e3)	20	22.2-24.5	5	32.4	10	231	22
MPLAD7.5KP22(C)A(e3)	22	24.4-26.9	5	35.5	10	211	24
MPLAD7.5KP24(C)A(e3)	24	26.7-29.5	5	38.9	10	193	27
MPLAD7.5KP26(C)A(e3)	26	28.9-31.9	5	42.1	10	178	29
MPLAD7.5KP28(C)A(e3)	28	31.1-34.4	5	45.5	10	165	30
MPLAD7.5KP30(C)A(e3)	30	33.3-36.8	5	48.4	10	155	35
MPLAD7.5KP33(C)A(e3)	33	36.7-40.6	5	53.3	10	141	38
MPLAD7.5KP36(C)A(e3)	36	40.0-44.2	5	58.1	10	129	40
MPLAD7.5KP40(C)A(e3)	40	44.4-49.1	5	64.5	10	116	45
MPLAD7.5KP43(C)A(e3)	43	47.8-52.8	5	69.4	10	108	49
MPLAD7.5KP45(C)A(e3)	45	50.0-55.3	5	72.7	10	103	51
MPLAD7.5KP48(C)A(e3)	48	53.3-58.9	5	77.4	10	97	54

Note:

1. See [Part Nomenclature](#) for additional screening prefixes and C suffix bidirectional option.

4. Graphs

Figure 4-1. Peak Pulse Power Vs. Pulse Time (to 50% of exponentially decaying pulse)

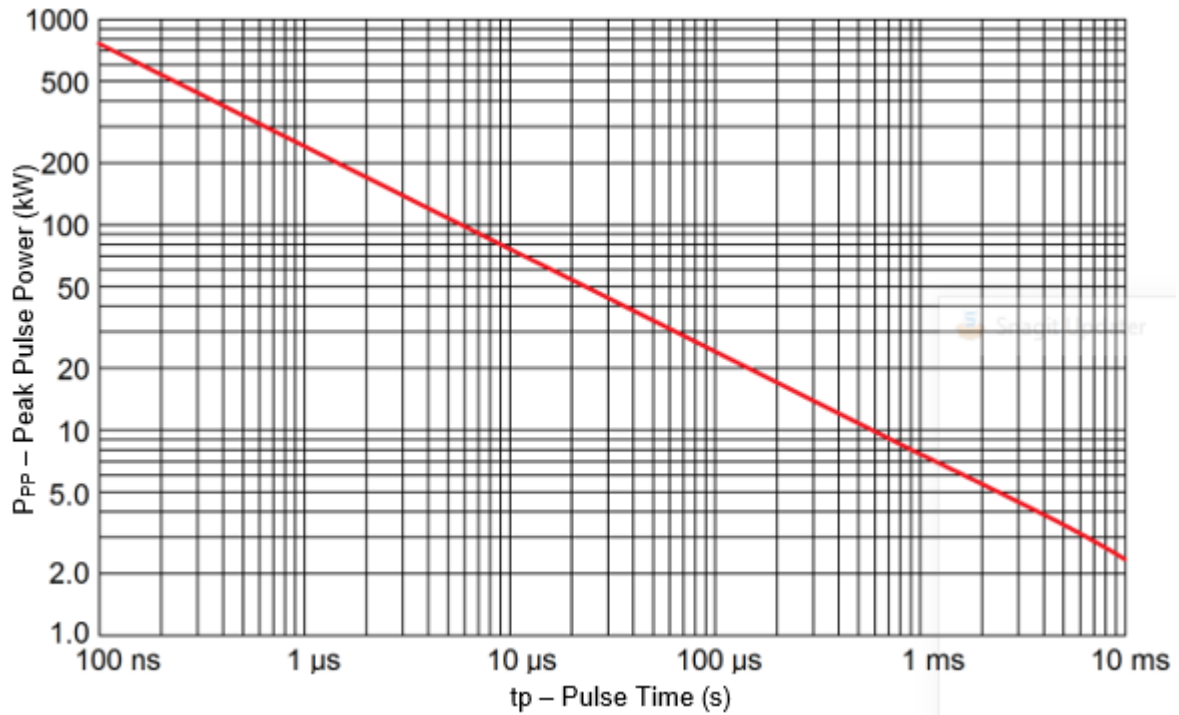

Figure 4-2. Pulse Waveform

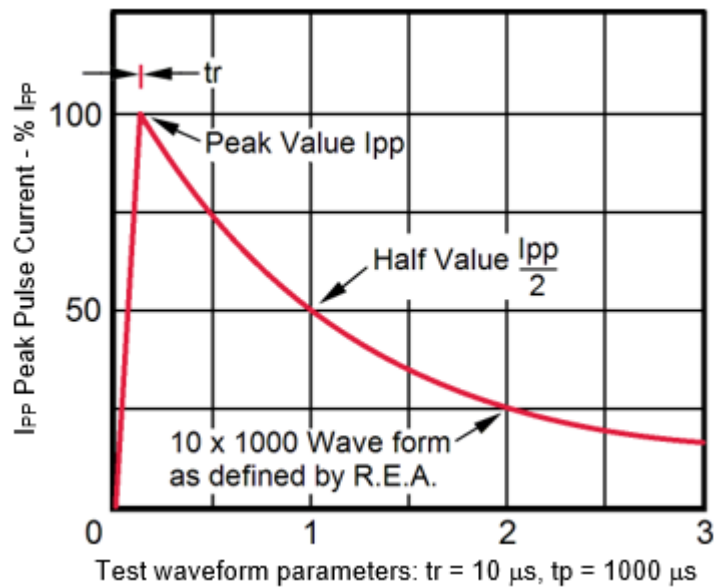
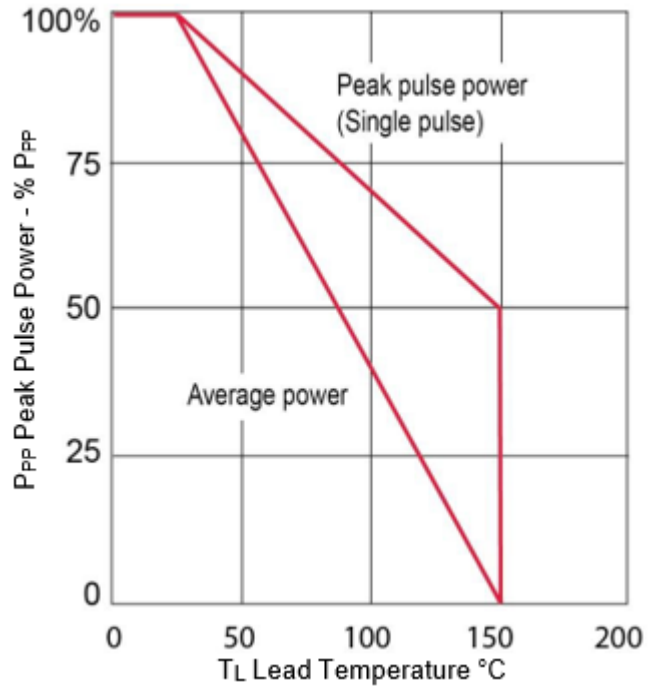
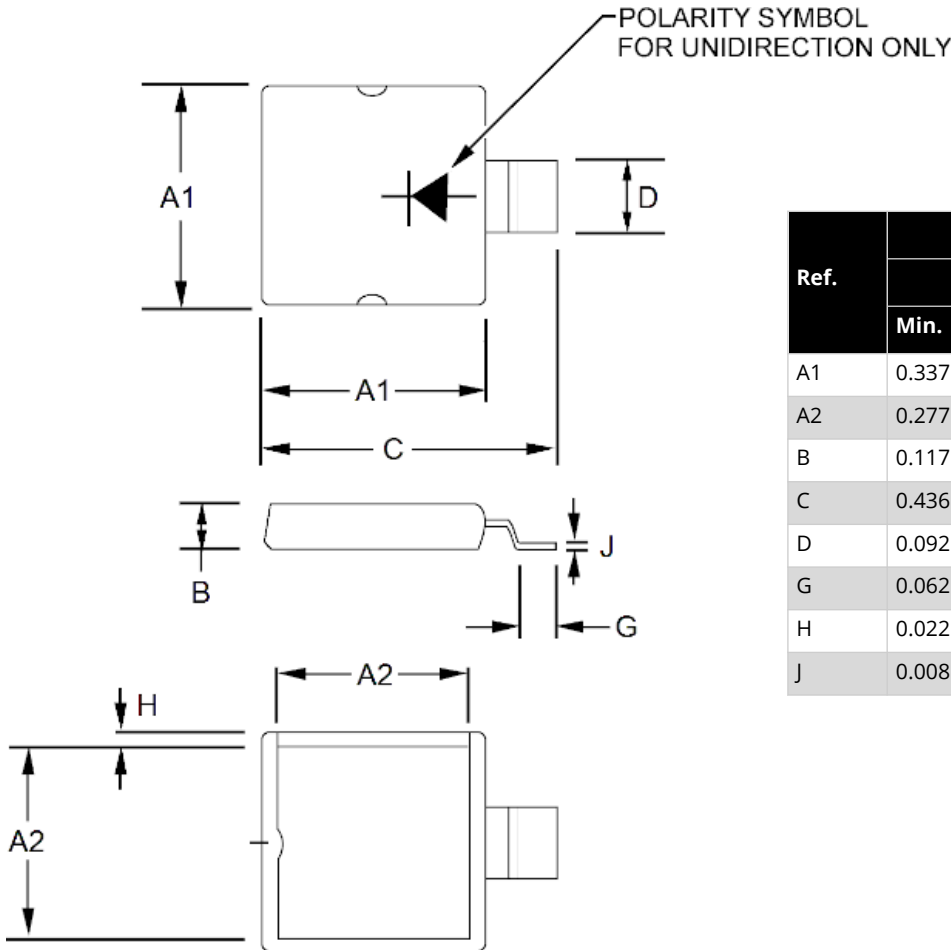

Figure 4-3. Derating Curve



5. Package Dimensions

Figure 5-1. Package Dimensions



Ref.	Dimensions			
	Inch		Millimeters	
	Min.	Max.	Min.	Max.
A1	0.337	0.353	8.56	8.97
A2	0.277	0.293	7.04	7.44
B	0.117	0.133	2.97	3.38
C	0.436	0.452	11.07	11.48
D	0.092	0.108	2.34	2.74
G	0.062	0.078	1.57	1.98
H	0.022	0.038	0.56	0.96
J	0.008	0.012	0.20	0.30

5.1 Pad Layout

Figure 5-2. Pad Layout

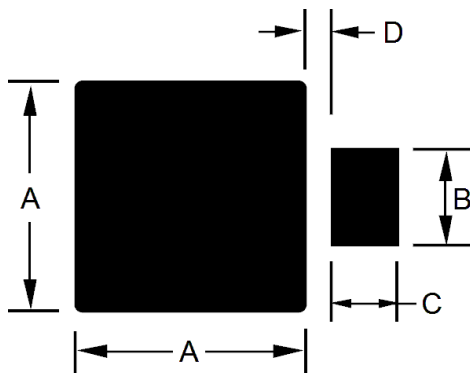

Ref.	Dimensions	
	Inch	Millimeters
A	Typical	Typical
A	0.353	8.97
B	0.117	2.97
C	0.078	1.98
D	0.033	0.84

6. Revision History

The revision history describes the changes that were implemented in the document. The changes are listed by revision, starting with the most current publication.

Revision	Date	Description
A	10/2023	Initial revision.

Microchip Information

The Microchip Website

Microchip provides online support via our website at www.microchip.com/. This website is used to make files and information easily available to customers. Some of the content available includes:

- **Product Support** – Data sheets and errata, application notes and sample programs, design resources, user’s guides and hardware support documents, latest software releases and archived software
- **General Technical Support** – Frequently Asked Questions (FAQs), technical support requests, online discussion groups, Microchip design partner program member listing
- **Business of Microchip** – Product selector and ordering guides, latest Microchip press releases, listing of seminars and events, listings of Microchip sales offices, distributors and factory representatives

Product Change Notification Service

Microchip’s product change notification service helps keep customers current on Microchip products. Subscribers will receive email notification whenever there are changes, updates, revisions or errata related to a specified product family or development tool of interest.

To register, go to www.microchip.com/pcn and follow the registration instructions.

Customer Support

Users of Microchip products can receive assistance through several channels:

- Distributor or Representative
- Local Sales Office
- Embedded Solutions Engineer (ESE)
- Technical Support

Customers should contact their distributor, representative or ESE for support. Local sales offices are also available to help customers. A listing of sales offices and locations is included in this document.

Technical support is available through the website at: www.microchip.com/support

Microchip Devices Code Protection Feature

Note the following details of the code protection feature on Microchip products:

- Microchip products meet the specifications contained in their particular Microchip Data Sheet.
- Microchip believes that its family of products is secure when used in the intended manner, within operating specifications, and under normal conditions.
- Microchip values and aggressively protects its intellectual property rights. Attempts to breach the code protection features of Microchip product is strictly prohibited and may violate the Digital Millennium Copyright Act.
- Neither Microchip nor any other semiconductor manufacturer can guarantee the security of its code. Code protection does not mean that we are guaranteeing the product is “unbreakable”. Code protection is constantly evolving. Microchip is committed to continuously improving the code protection features of our products.

Legal Notice

This publication and the information herein may be used only with Microchip products, including to design, test, and integrate Microchip products with your application. Use of this information in any other manner violates these terms. Information regarding device applications is provided only for your convenience and may be superseded by updates. It is your responsibility to ensure

that your application meets with your specifications. Contact your local Microchip sales office for additional support or, obtain additional support at www.microchip.com/en-us/support/design-help/client-support-services.

THIS INFORMATION IS PROVIDED BY MICROCHIP "AS IS". MICROCHIP MAKES NO REPRESENTATIONS OR WARRANTIES OF ANY KIND WHETHER EXPRESS OR IMPLIED, WRITTEN OR ORAL, STATUTORY OR OTHERWISE, RELATED TO THE INFORMATION INCLUDING BUT NOT LIMITED TO ANY IMPLIED WARRANTIES OF NON-INFRINGEMENT, MERCHANTABILITY, AND FITNESS FOR A PARTICULAR PURPOSE, OR WARRANTIES RELATED TO ITS CONDITION, QUALITY, OR PERFORMANCE.

IN NO EVENT WILL MICROCHIP BE LIABLE FOR ANY INDIRECT, SPECIAL, PUNITIVE, INCIDENTAL, OR CONSEQUENTIAL LOSS, DAMAGE, COST, OR EXPENSE OF ANY KIND WHATSOEVER RELATED TO THE INFORMATION OR ITS USE, HOWEVER CAUSED, EVEN IF MICROCHIP HAS BEEN ADVISED OF THE POSSIBILITY OR THE DAMAGES ARE FORESEEABLE. TO THE FULLEST EXTENT ALLOWED BY LAW, MICROCHIP'S TOTAL LIABILITY ON ALL CLAIMS IN ANY WAY RELATED TO THE INFORMATION OR ITS USE WILL NOT EXCEED THE AMOUNT OF FEES, IF ANY, THAT YOU HAVE PAID DIRECTLY TO MICROCHIP FOR THE INFORMATION.

Use of Microchip devices in life support and/or safety applications is entirely at the buyer's risk, and the buyer agrees to defend, indemnify and hold harmless Microchip from any and all damages, claims, suits, or expenses resulting from such use. No licenses are conveyed, implicitly or otherwise, under any Microchip intellectual property rights unless otherwise stated.

Trademarks

The Microchip name and logo, the Microchip logo, Adaptec, AVR, AVR logo, AVR Freaks, BesTime, BitCloud, CryptoMemory, CryptoRF, dsPIC, flexPWR, HELDO, IGLOO, JukeBlox, KeeLoq, Kleer, LANCheck, LinkMD, maXStylus, maXTouch, MediaLB, megaAVR, Microsemi, Microsemi logo, MOST, MOST logo, MPLAB, OptoLyzer, PIC, picoPower, PICSTART, PIC32 logo, PolarFire, Prochip Designer, QTouch, SAM-BA, SenGenuity, SpyNIC, SST, SST Logo, SuperFlash, Symmetricom, SyncServer, Tachyon, TimeSource, tinyAVR, UNI/O, Vectron, and XMEGA are registered trademarks of Microchip Technology Incorporated in the U.S.A. and other countries.

AgileSwitch, ClockWorks, The Embedded Control Solutions Company, EtherSynch, Flashtec, Hyper Speed Control, HyperLight Load, Libero, motorBench, mTouch, Powermite 3, Precision Edge, ProASIC, ProASIC Plus, ProASIC Plus logo, Quiet-Wire, SmartFusion, SyncWorld, TimeCesium, TimeHub, TimePictra, TimeProvider, and ZL are registered trademarks of Microchip Technology Incorporated in the U.S.A.

Adjacent Key Suppression, AKS, Analog-for-the-Digital Age, Any Capacitor, AnyIn, AnyOut, Augmented Switching, BlueSky, BodyCom, Clockstudio, CodeGuard, CryptoAuthentication, CryptoAutomotive, CryptoCompanion, CryptoController, dsPICDEM, dsPICDEM.net, Dynamic Average Matching, DAM, ECAN, Espresso T1S, EtherGREEN, EyeOpen, GridTime, IdealBridge, IGaT, In-Circuit Serial Programming, ICSP, INICnet, Intelligent Paralleling, IntelliMOS, Inter-Chip Connectivity, JitterBlocker, Knob-on-Display, MarginLink, maxCrypto, maxView, memBrain, Mindi, MiWi, MPASM, MPF, MPLAB Certified logo, MPLIB, MPLINK, mSiC, MultiTRAK, NetDetach, Omniscient Code Generation, PICDEM, PICDEM.net, PICkit, PICtail, Power MOS IV, Power MOS 7, PowerSmart, PureSilicon, QMatrix, REAL ICE, Ripple Blocker, RTAX, RTG4, SAM-ICE, Serial Quad I/O, simpleMAP, SimpliPHY, SmartBuffer, SmartHLS, SMART-I.S., storClad, SQI, SuperSwitcher, SuperSwitcher II, Switchtec, SynchroPHY, Total Endurance, Trusted Time, TSHARC, Turing, USBCheck, VariSense, VectorBlox, VeriPHY, ViewSpan, WiperLock, XpressConnect, and ZENA are trademarks of Microchip Technology Incorporated in the U.S.A. and other countries.

SQTP is a service mark of Microchip Technology Incorporated in the U.S.A.

The Adaptec logo, Frequency on Demand, Silicon Storage Technology, and Symmcom are registered trademarks of Microchip Technology Inc. in other countries.

GestIC is a registered trademark of Microchip Technology Germany II GmbH & Co. KG, a subsidiary of Microchip Technology Inc., in other countries.

All other trademarks mentioned herein are property of their respective companies.

© 2021-2023, Microchip Technology Incorporated and its subsidiaries. All Rights Reserved.

ISBN: 978-1-6683-3299-3

Quality Management System

For information regarding Microchip's Quality Management Systems, please visit www.microchip.com/quality.

Worldwide Sales and Service

AMERICAS	ASIA/PACIFIC	ASIA/PACIFIC	EUROPE
<p>Corporate Office 2355 West Chandler Blvd. Chandler, AZ 85224-6199 Tel: 480-792-7200 Fax: 480-792-7277 Technical Support: www.microchip.com/support Web Address: www.microchip.com</p> <p>Atlanta Duluth, GA Tel: 678-957-9614 Fax: 678-957-1455</p> <p>Austin, TX Tel: 512-257-3370</p> <p>Boston Westborough, MA Tel: 774-760-0087 Fax: 774-760-0088</p> <p>Chicago Itasca, IL Tel: 630-285-0071 Fax: 630-285-0075</p> <p>Dallas Addison, TX Tel: 972-818-7423 Fax: 972-818-2924</p> <p>Detroit Novi, MI Tel: 248-848-4000</p> <p>Houston, TX Tel: 281-894-5983</p> <p>Indianapolis Noblesville, IN Tel: 317-773-8323 Fax: 317-773-5453 Tel: 317-536-2380</p> <p>Los Angeles Mission Viejo, CA Tel: 949-462-9523 Fax: 949-462-9608 Tel: 951-273-7800</p> <p>Raleigh, NC Tel: 919-844-7510</p> <p>New York, NY Tel: 631-435-6000</p> <p>San Jose, CA Tel: 408-735-9110 Tel: 408-436-4270</p> <p>Canada - Toronto Tel: 905-695-1980 Fax: 905-695-2078</p>	<p>Australia - Sydney Tel: 61-2-9868-6733</p> <p>China - Beijing Tel: 86-10-8569-7000</p> <p>China - Chengdu Tel: 86-28-8665-5511</p> <p>China - Chongqing Tel: 86-23-8980-9588</p> <p>China - Dongguan Tel: 86-769-8702-9880</p> <p>China - Guangzhou Tel: 86-20-8755-8029</p> <p>China - Hangzhou Tel: 86-571-8792-8115</p> <p>China - Hong Kong SAR Tel: 852-2943-5100</p> <p>China - Nanjing Tel: 86-25-8473-2460</p> <p>China - Qingdao Tel: 86-532-8502-7355</p> <p>China - Shanghai Tel: 86-21-3326-8000</p> <p>China - Shenyang Tel: 86-24-2334-2829</p> <p>China - Shenzhen Tel: 86-755-8864-2200</p> <p>China - Suzhou Tel: 86-186-6233-1526</p> <p>China - Wuhan Tel: 86-27-5980-5300</p> <p>China - Xian Tel: 86-29-8833-7252</p> <p>China - Xiamen Tel: 86-592-2388138</p> <p>China - Zhuhai Tel: 86-756-3210040</p>	<p>India - Bangalore Tel: 91-80-3090-4444</p> <p>India - New Delhi Tel: 91-11-4160-8631</p> <p>India - Pune Tel: 91-20-4121-0141</p> <p>Japan - Osaka Tel: 81-6-6152-7160</p> <p>Japan - Tokyo Tel: 81-3-6880-3770</p> <p>Korea - Daegu Tel: 82-53-744-4301</p> <p>Korea - Seoul Tel: 82-2-554-7200</p> <p>Malaysia - Kuala Lumpur Tel: 60-3-7651-7906</p> <p>Malaysia - Penang Tel: 60-4-227-8870</p> <p>Philippines - Manila Tel: 63-2-634-9065</p> <p>Singapore Tel: 65-6334-8870</p> <p>Taiwan - Hsin Chu Tel: 886-3-577-8366</p> <p>Taiwan - Kaohsiung Tel: 886-7-213-7830</p> <p>Taiwan - Taipei Tel: 886-2-2508-8600</p> <p>Thailand - Bangkok Tel: 66-2-694-1351</p> <p>Vietnam - Ho Chi Minh Tel: 84-28-5448-2100</p>	<p>Austria - Wels Tel: 43-7242-2244-39 Fax: 43-7242-2244-393</p> <p>Denmark - Copenhagen Tel: 45-4485-5910 Fax: 45-4485-2829</p> <p>Finland - Espoo Tel: 358-9-4520-820</p> <p>France - Paris Tel: 33-1-69-53-63-20 Fax: 33-1-69-30-90-79</p> <p>Germany - Garching Tel: 49-8931-9700</p> <p>Germany - Haan Tel: 49-2129-3766400</p> <p>Germany - Heilbronn Tel: 49-7131-72400</p> <p>Germany - Karlsruhe Tel: 49-721-625370</p> <p>Germany - Munich Tel: 49-89-627-144-0 Fax: 49-89-627-144-44</p> <p>Germany - Rosenheim Tel: 49-8031-354-560</p> <p>Israel - Ra'anana Tel: 972-9-744-7705</p> <p>Italy - Milan Tel: 39-0331-742611 Fax: 39-0331-466781</p> <p>Italy - Padova Tel: 39-049-7625286</p> <p>Netherlands - Drunen Tel: 31-416-690399 Fax: 31-416-690340</p> <p>Norway - Trondheim Tel: 47-72884388</p> <p>Poland - Warsaw Tel: 48-22-3325737</p> <p>Romania - Bucharest Tel: 40-21-407-87-50</p> <p>Spain - Madrid Tel: 34-91-708-08-90 Fax: 34-91-708-08-91</p> <p>Sweden - Gothenberg Tel: 46-31-704-60-40</p> <p>Sweden - Stockholm Tel: 46-8-5090-4654</p> <p>UK - Wokingham Tel: 44-118-921-5800 Fax: 44-118-921-5820</p>