

Mechanical Dimensions: Inches [mm]

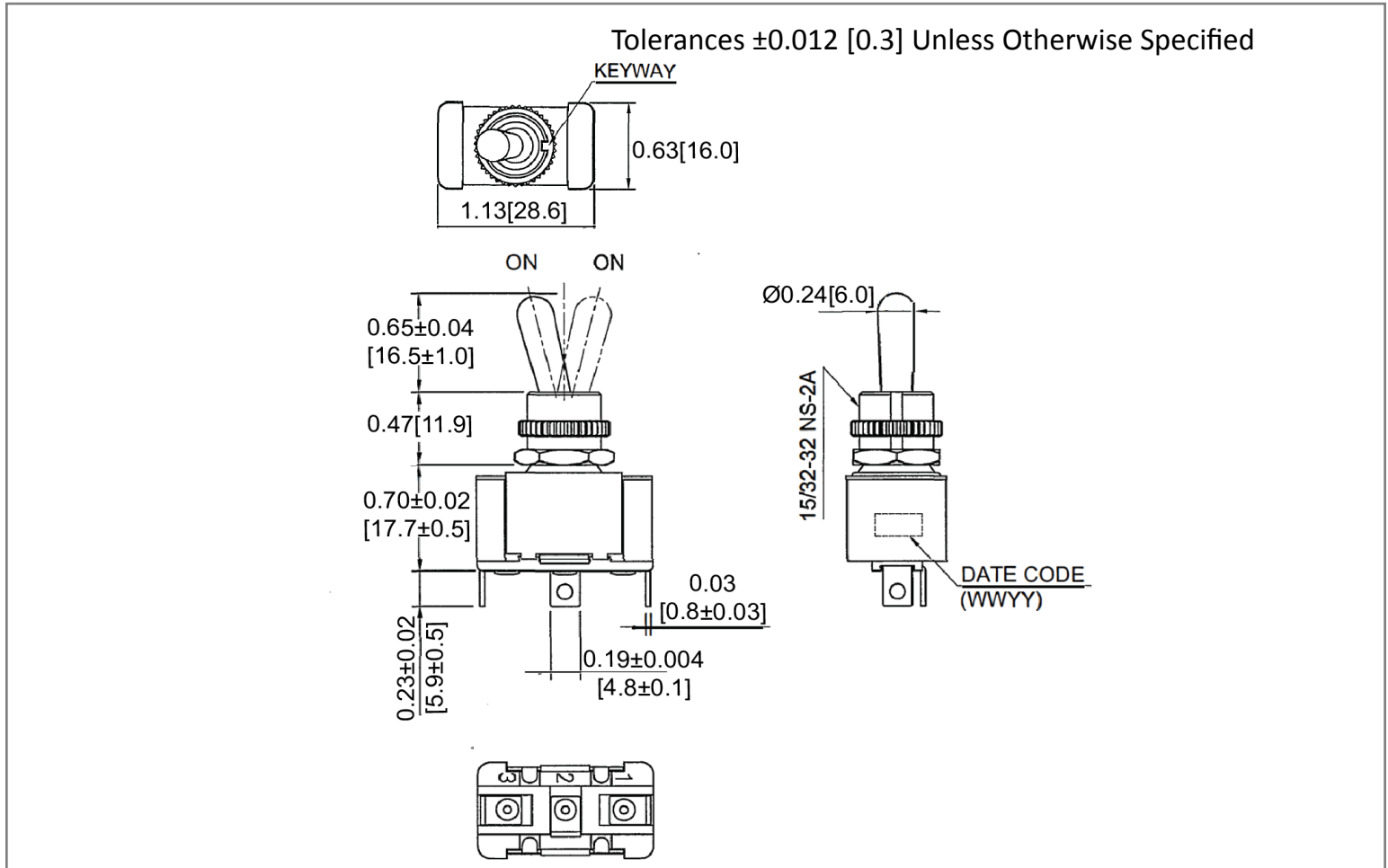

Mounting Hole

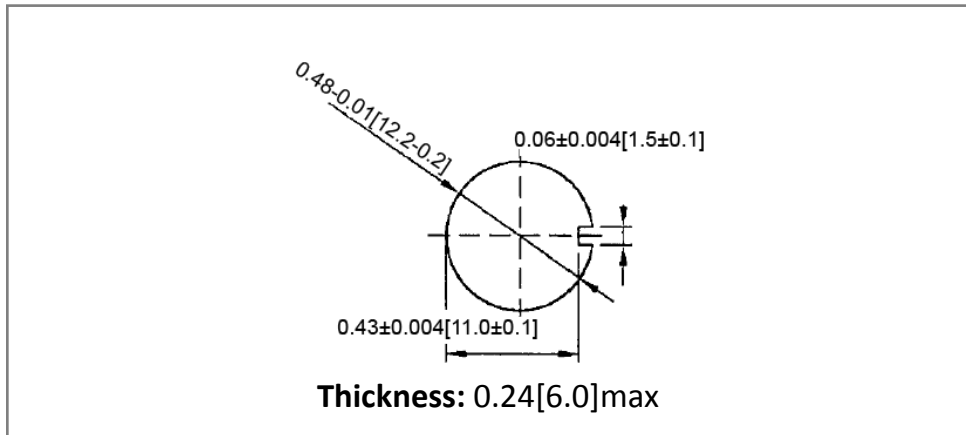

Circuit Diagram

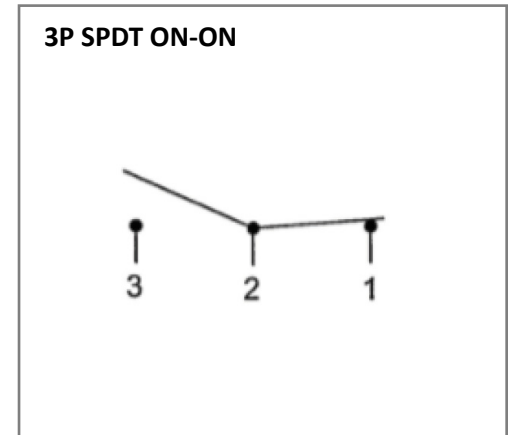

Electrical Specifications

DC Rating	21A 14V DC
AC Rating	20A 125V AC, 10A 277V AC, 3/4HP 125-250V AC 12(4)A 125/250V AC
Contact Resistance	50m ohm Max
Insulation Resistance	DC 500V 100M ohm Min
Dielectric Strength	AC 1500V 1 minute

Material Specifications

Operation Force	700gf \pm 250 gf
	1 Hex Nut Assy
	1 Knurl Nut Assy
Operation Temperature	-20°C ~ 85°C

Rev	Date of issue	Revision Notes	Designed	Approved
B	03-04-2020	Initial Drawing	RC	OF