

200R SERIES TOGGLE SWITCH

ANTI-VANDAL SWITCHES
 DETECTOR SWITCHES
 DIP SWITCHES
 KEYLOCK SWITCHES
 NAVIGATION SWITCHES
 PUSHBUTTON SWITCHES
 ROCKER SWITCHES
 ROTARY SWITCHES
 SLIDE SWITCHES
 SNAP ACTION SWITCHES
 TACTILE SWITCHES
TOGGLE SWITCHES
 CAP OPTIONS

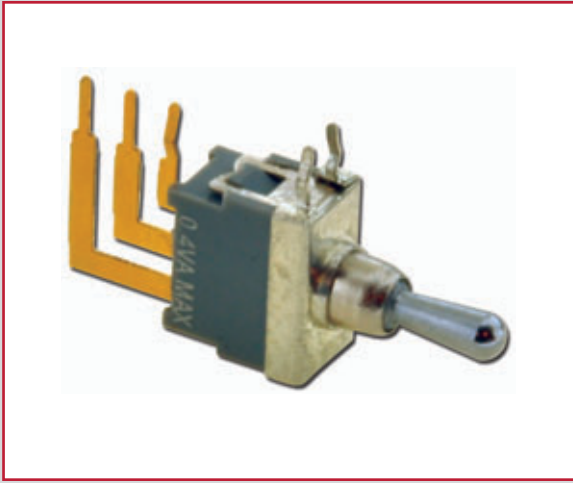

APPLICATIONS / MARKETS



Audio / Visual

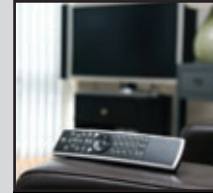

Consumer Electronics



Vending Machines

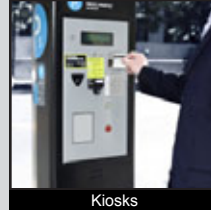

Kiosks

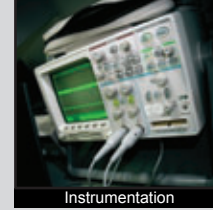

Instrumentation



Medical Equipment

RoHS

SPECIFICATIONS

Electrical Rating: 0.4VA Max@ 48V (AC or DC)
Mechanical Life: 40,000 Cycles
Contact Resistance: 50mΩ Max. initial
Insulation Resistance: 1,000MΩ
Dielectric Strength: 500V
Operating/Storage Temperature: -30°C to 85°C
Circuit Function: SP or DP

FEATURES & BENEFITS

- Multiple termination options
- Single or double pole
- Available in both 2 or 3 position circuits
- Miniature in size
- Gold contacts

PART NUMBER CONFIGURATOR

Series	Circuit	Toggle	Bushing	Termination	Contact Material
<input type="text" value="2"/> <input type="text" value="0"/> <input type="text" value="0"/> <input type="text" value="R"/> 200R	<input type="text" value="S"/> <input type="text" value="P"/> <input type="text" value="1"/> SP1 - ON-NONE-ON SP2 - ON-NONE-(ON) SP3 - ON-OFF-ON SP4 - (ON)-OFF-(ON) SP5 - ON-OFF-(ON) <input type="text" value="D"/> <input type="text" value="P"/> <input type="text" value="1"/> DP1 - ON-NONE-ON DP2 - ON-NONE-(ON) DP3 - ON-OFF-ON DP4 - (ON)-OFF-(ON) DP5 - ON-OFF-(ON)	<input type="text" value="T"/> <input type="text" value="1"/> T1	<input type="text" value="B"/> <input type="text" value="1"/> B1	<input type="text" value="M"/> <input type="text" value="2"/> <input type="text" value="M"/> <input type="text" value="6"/> <input type="text" value="M"/> <input type="text" value="7"/> M2 M6 M7	<input type="text" value="R"/> R - Gold

* () denotes momentary

Specifications subject to change without notice



E-SWITCH®

www.e-switch.com

800.867.2717

2

200R SERIES TOGGLE SWITCH

M2 TERMINATION

Single Pole

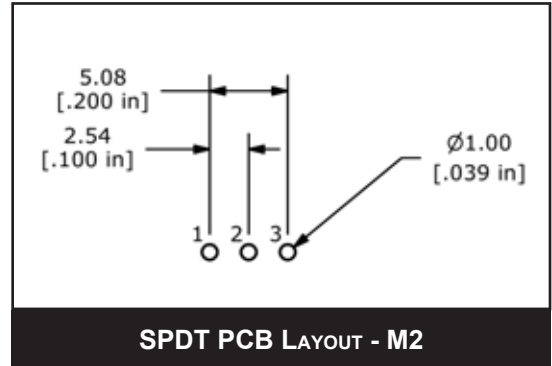
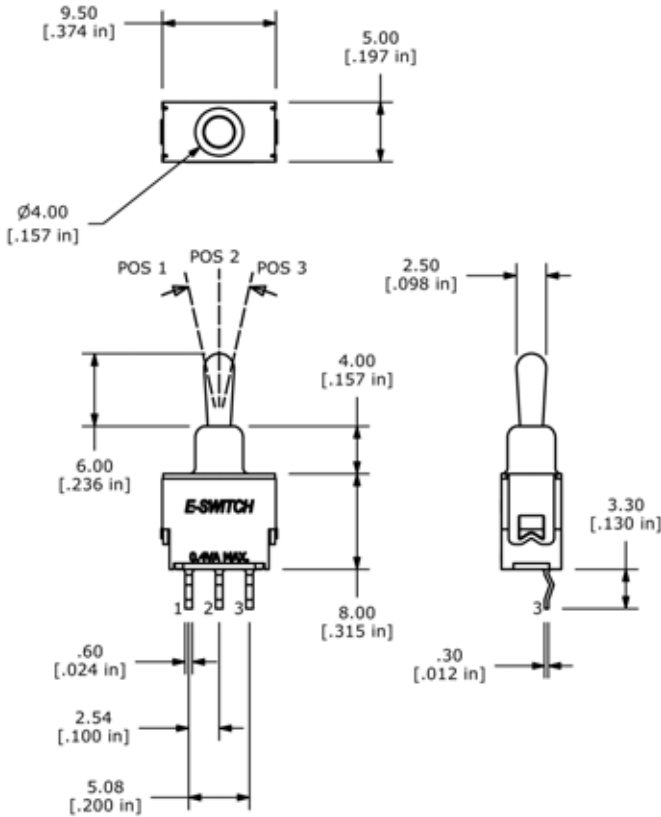

Double Pole

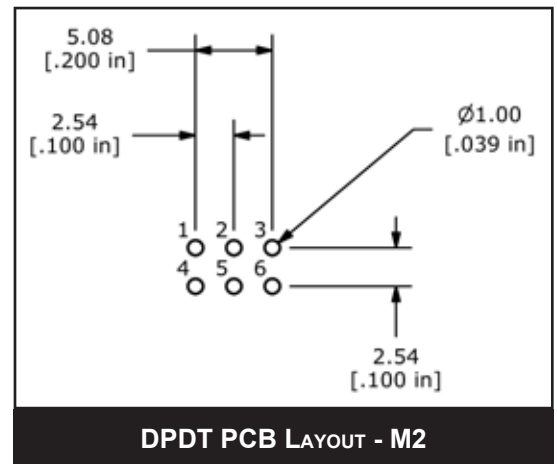
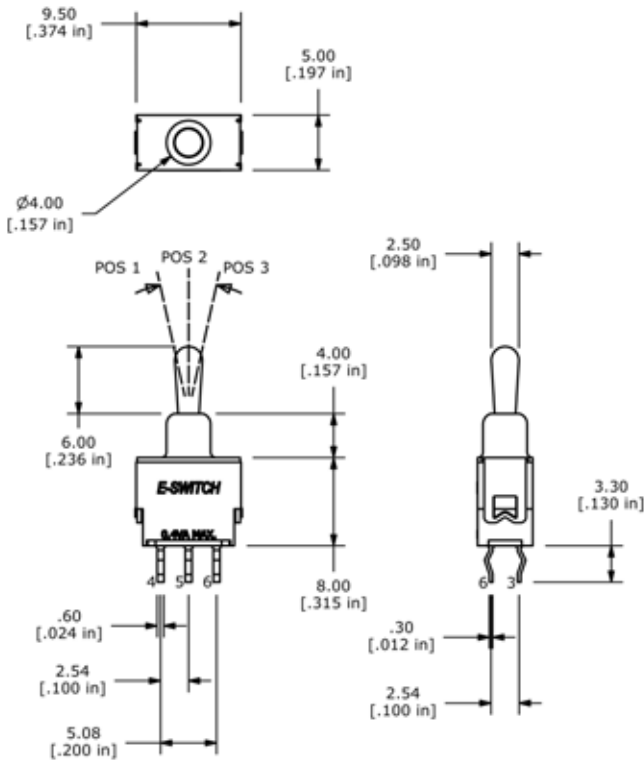

200R SERIES TOGGLE SWITCH

M6 TERMINATION

Single Pole

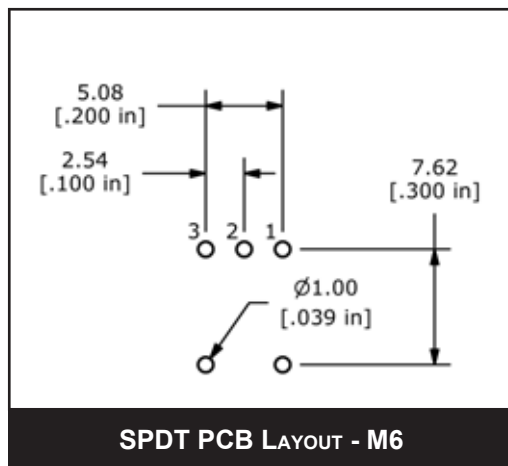
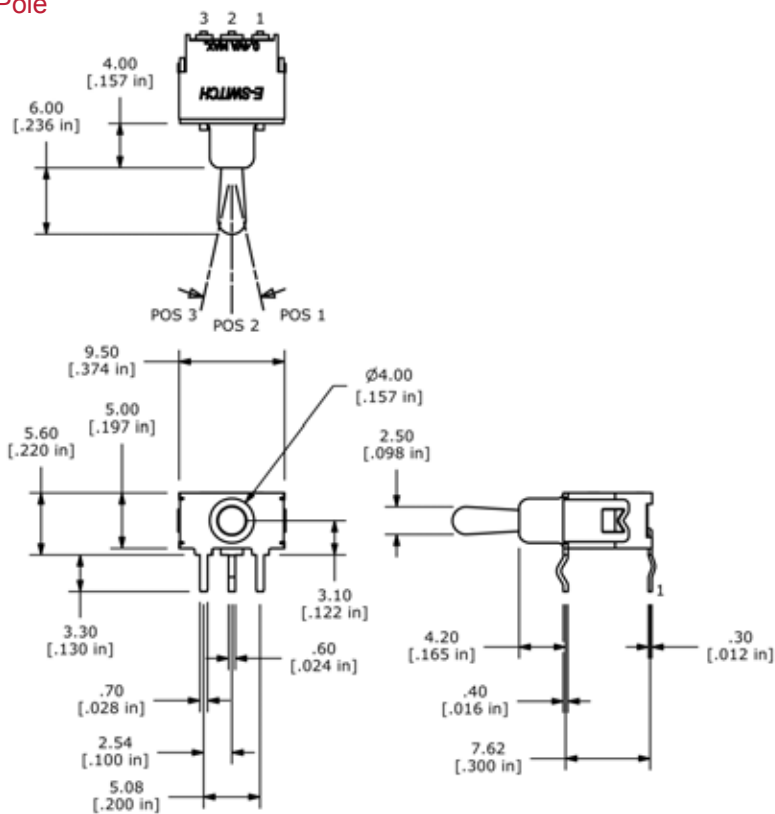

SPDT PCB LAYOUT - M6

Double Pole

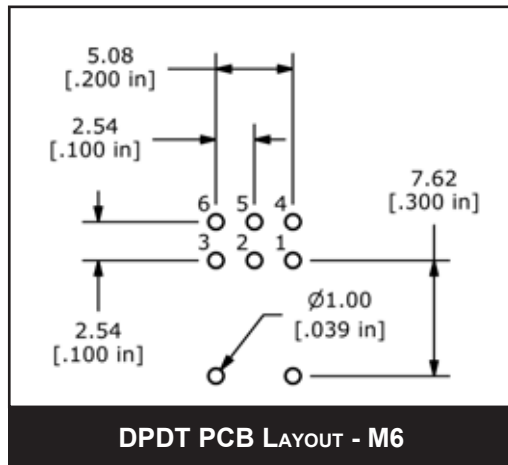
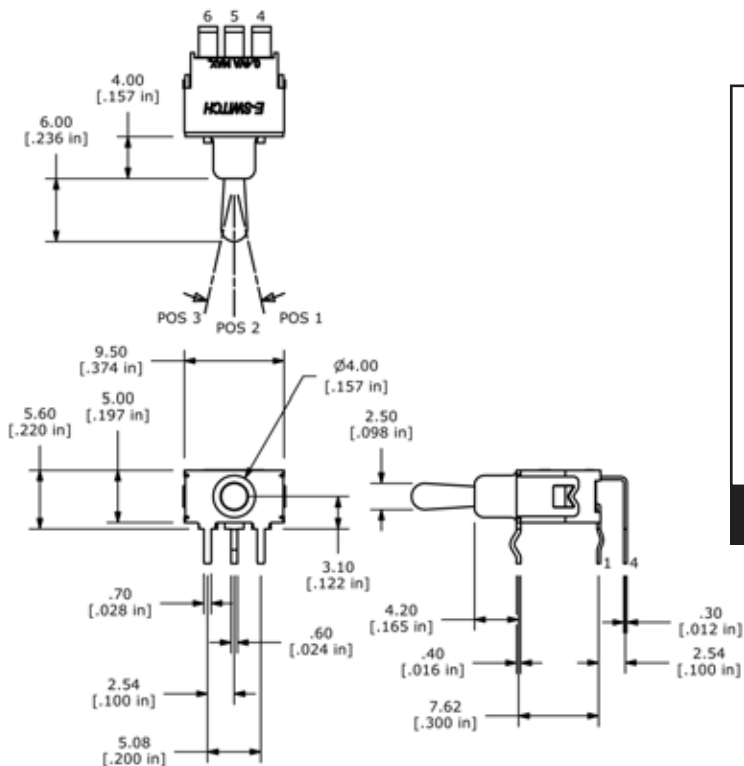

DPDT PCB LAYOUT - M6



M7 TERMINATION

Single Pole

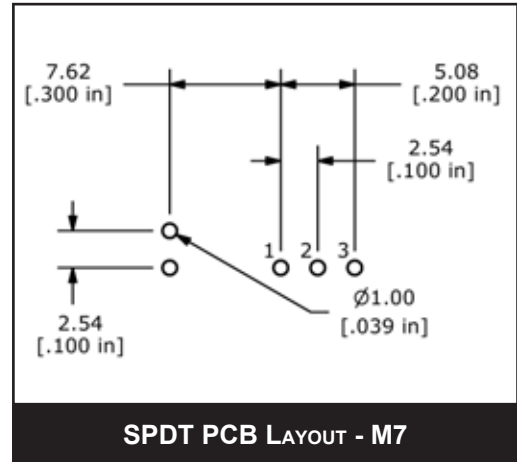
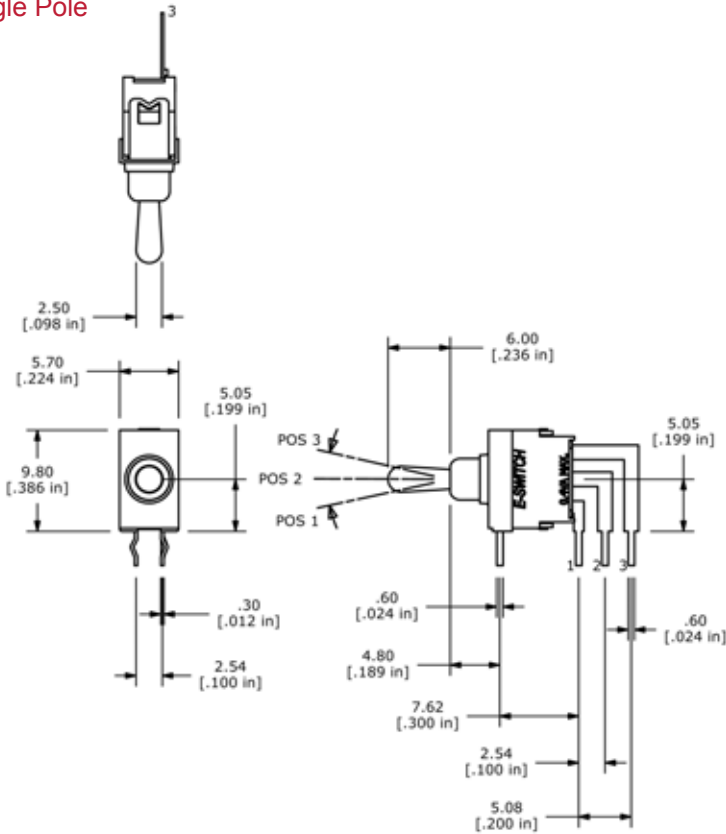

Double Pole

