



MUR1505 THRU MUR1560

VOLTAGE RANGE	100 to 600 Volts
CURRENT	15.0 Ampere

Features

- Low power loss, high efficiency, High surge capacity
- For use in low voltage, high frequency inverters
- Metal silicon junction, majority carrier conduction
- High current Capability, low forward voltage drop
- Guard ring for over voltage protection

TO-220AC

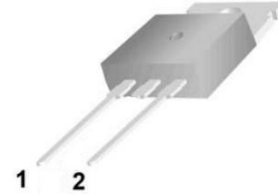

Mechanical Data

- Case: TO-220AC molded plastic over glass passivated chip
- Case: Copper base plate & Plastic Shell
- Molding compound meets UL 94 V-0 flammability rating, Halogen-free, RoHS-compliant, and commercial grade
- Weight: 0.08ounce, 2.24 gram

Maximum Ratings and Electrical Characteristics

- Ratings at 25°C ambient temperature unless otherwise specified
- Single Phase, half wave, 60Hz, resistive or inductive load
- For capacitive load derate current by 20%

TYPE NUMBER	SYMBOL	MUR 1505	MUR 1510	MUR 1520	MUR 1530	MUR 1540	MUR 1560	UNIT
Maximum Repetitive Peak Reverse Voltage	V_{RRM}	100	150	200	300	400	600	Volts
Maximum RMS Voltage	V_{RMS}	70	105	140	210	280	420	Volts
Maximum DC Blocking Voltage	V_{DC}	100	100	200	300	400	600	Volts
Maximum Average Forward Rectified Current 0.375"(9.5mm) lead length at $T_A=100^\circ\text{C}$	$I_{(AV)}$	15						Amps
Peak Forward Surge Current 8.3mS single half sine wave superimposed on rated load (JEDEC method)	I_{FSM}	200						Amps
Maximum Instantaneous Forward Voltage at 15A	V_F	0.95		1.25		1.70		Volts
Maximum DC Reverse Current at rated DC blocking Voltage at	$T_A = 25^\circ\text{C}$	5.0						μA
	$T_A = 125^\circ\text{C}$	50						
Maximum Reverse Recovery Time ^(NOTE 1)	T_{RR}	35		50				nS
Typical Junction Capacitance ^(NOTE 2)	C_J	62						pF
Typical Thermal Resistance ^(NOTE 3)	$R_{\theta JA}$	1.4						$^\circ\text{C}/\text{W}$
Operating Junction Temperature Range	T_J	(-55 to +150)						$^\circ\text{C}$
Storage Temperature Range	T_{STG}	(-55 to +150)						$^\circ\text{C}$

Notes:

1. Reverse Recovery Test Conditions: $I_f=0.5\text{A}$, $I_r=1.0\text{A}$, $I_{rr}=0.25\text{A}$.
2. Measured at 1.0MHz and applied reverse voltage of 4.0 Volts.
3. Unit mounted on P.C.B. with 0.033"x0.043"(1.00mmx1.30mm) copper pads.



MUR1505 THRU MUR1560

Ratings and Characteristic Curves ($T_A=25^\circ\text{C}$ unless otherwise noted)

FIG.1-TYPICAL FORWARD CURRENT DERATING CURVE

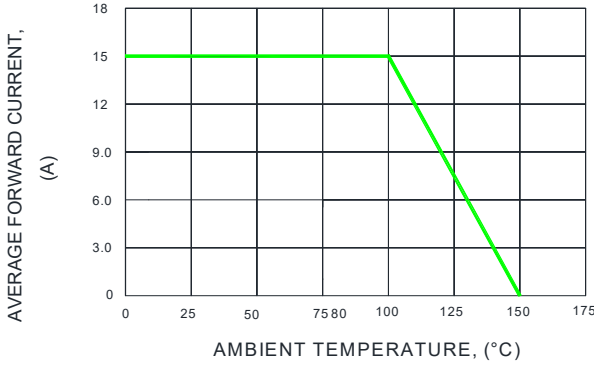

FIG.2-MAXIMUM NON-REPETITIVE PEAK FORWARD SURGE CURRENT

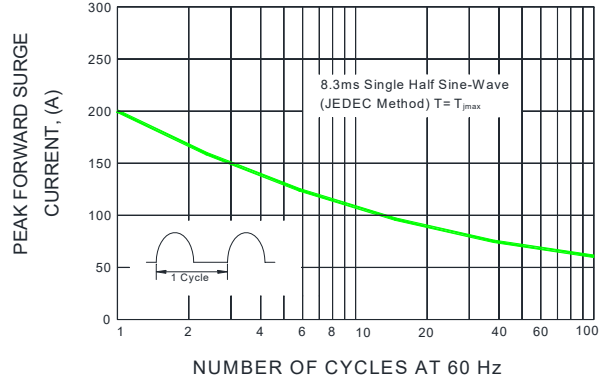

FIG.3-TYPICAL INSTANTANEOUS FORWARD CHARACTERISTICS

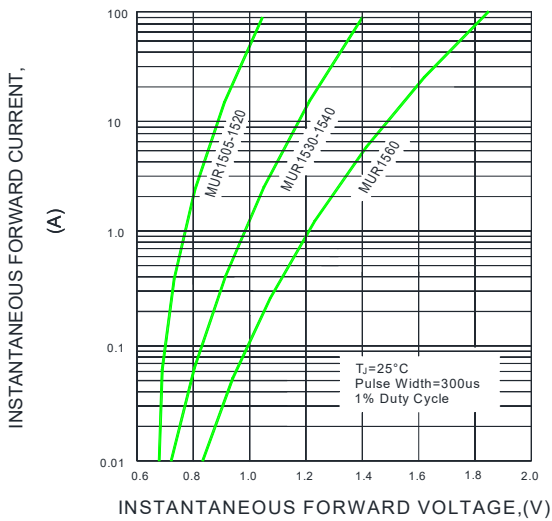

FIG.4-TYPICAL REVERSE CHARACTERISTICS

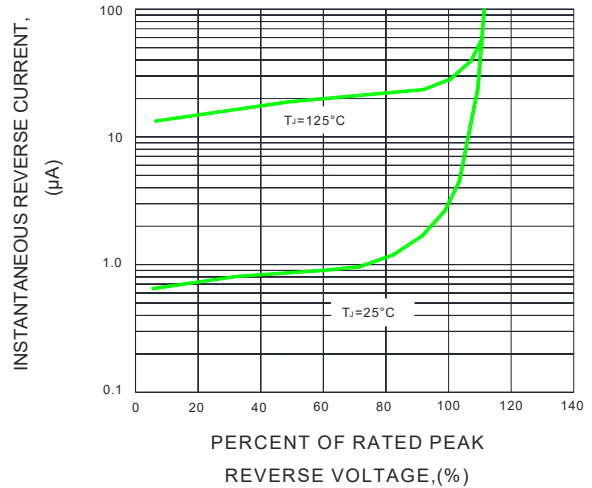

FIG.5-TYPICAL JUNCTION CAPACITANCE

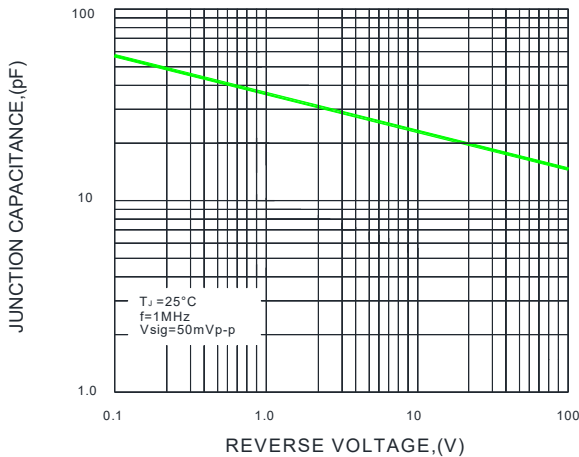
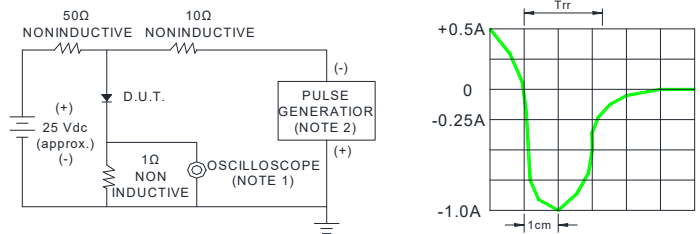

FIG.6-TEST CIRCUIT DIAGRAM AND REVERSE RECOVERY TIME CHARACTERISTIC



NOTES : 1.Rise Time=7ns mas. Input Impedance= 1 magohm. 22pF
2.Rise time=10ns max. Source Impedance= 50 ohms

SET TIME BASE FOR 50/100ns/cm



15A SUPER FAST BARRIER RECTIFIER

MUR1505 THRU MUR1560

VOLTAGE RANGE 100 to 600 Volts
CURRENT 15.0 Ampere

Package Outline Dimensions millimeters

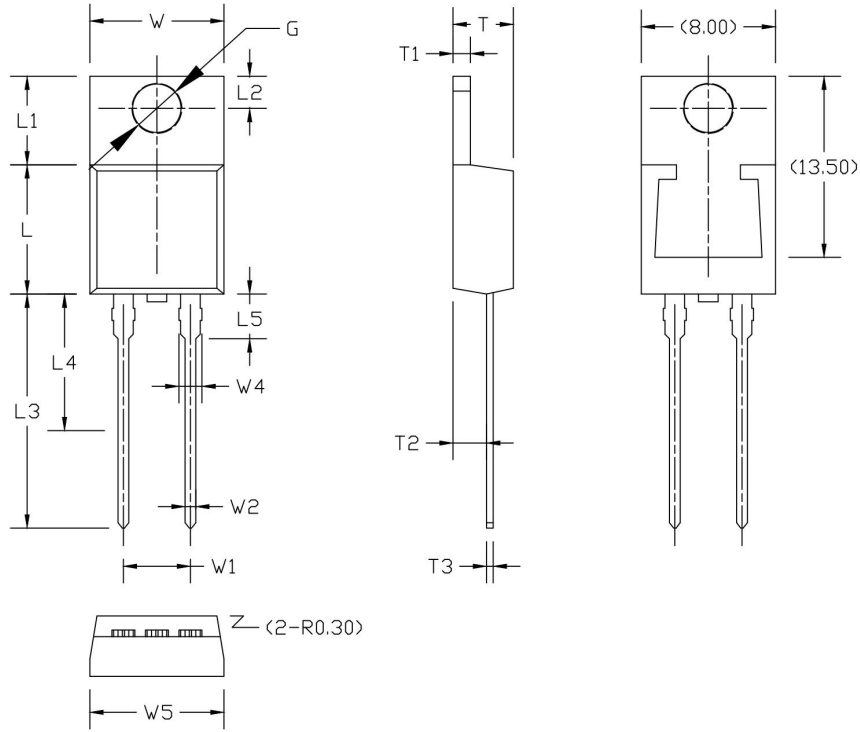

Symbol	Size		Symbol	Size		Symbol	Size		Symbol	Size	
	Min	Max		Min	Max		Min	Max		Min	Max
W	9.66	10.28	L	8.30	9.00	L5	3.69	4.10	G(Φ)	3.70	3.90
W1	5.08 (TYP)		L1	6.10	6.60	T	4.30	4.70			
W2	0.70	0.95	L2	2.70	2.90	T1	1.15	1.40			
W3	1.17	1.37	L3	12.70	14.27	T2	2.20	2.80			
W4*	1.32	1.72	L4	6.60	7.10	T3	0.35	0.45			



Reflow Profile

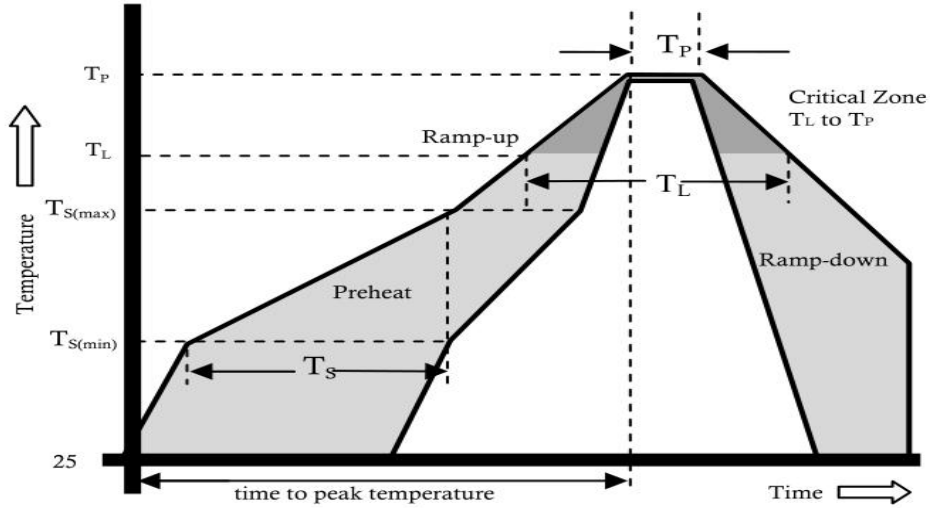

Reflow Condition		Pb-Free Assembly
Pre Heat	Temperature Min.	+150°C
	Temperature Max.	+200°C
	Time(Min to Max)	60-180 secs.
Average ramp up rate(Liquidus Temp(T_L) to peak)		3°C/sec. Max.
TS(max) to T_L - Ramp-up Rate		3°C/sec. Max.
Reflow	Temperature (T_L)(Liquidus)	+217°C
	Temperature (T_L)	60-150 secs.
Peak Temp (T_P)		+(260±0/-5)°C
Time within 5°C of actual Peak Temp (T_P)		25 secs.
Ramp-down Rate		6°C/sec. Max.
Time 25°C to peak Temp (T_P)		8 min. Max.
Do not exceed		+260°C

**MUR1505 THRU MUR1560**

VOLTAGE RANGE	100 to 600 Volts
CURRENT	15.0 Ampere

Disclaimer

The information presented in this document is for reference only. Chongqing changjie Electronic Technology Co., Ltd. reserves the right to make changes without notice for the specification of the products displayed herein to improve reliability, function or design or otherwise.

The product listed herein is designed to be used with ordinary electronic equipment or devices, and not designed to be used with equipment or devices which require high level of reliability and the malfunction of which would directly endanger human life (such as medical instruments, transportation equipment, aerospace machinery, nuclear-reactor controllers, fuel controllers and other safety devices), Changjie or anyone on its behalf, assumes no responsibility or liability for any damages resulting from such improper use of sale.

This publication supersedes & replaces all information previously supplied. For additional information, please visit our website [http:// www.czlangjie.com](http://www.czlangjie.com) , or consult your nearest Langjie's sales office for further assistance.