

DATA SHEET

CLA Series: Silicon Limiter Diode Bondable Chips

Applications

- LNA receiver protection
- Commercial and defense radar

Features

- Established Skyworks limiter diode process
- High-power, mid-range, and cleanup designs
- Low insertion loss: 0.1 dB @ 2.6 GHz
- Peak power handling to +74 dBm
- Ultra-low spike leakage power
- Tight control of I layer base width
- Mesa and planar chip designs



Skyworks Green™ products are compliant with all applicable legislation and are halogen-free. For additional information, refer to *Skyworks Definition of Green™*, document number SQ04-0074.

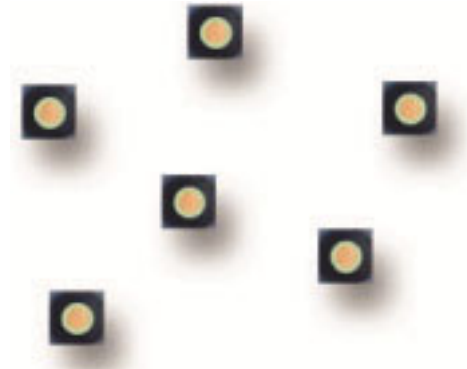

Description

The Skyworks CLA series of silicon limiter diodes provides passive receiver protection over a wide range of frequencies from 100 MHz to over 30 GHz. These devices use the well-established Skyworks silicon technology resulting in high resistivity and tightly controlled base width PIN limiter diodes. Limiter circuits using these devices perform with strong limiting action and low loss.

The CLA series consists of eleven individual chip designs of different intrinsic region base widths and capacitances designed to accommodate multi-stage limiter applications. The mesa-constructed, thin base width, low capacitance CLA4601-000, CLA4602-000, CLA4604-000, CLA4605-000, and CLA4611-000 are designed for low-level and cleanup applications. The CLA4603-000, CLA4606-000 through CLA4608-000, and CLA4610-000 are planar designs designated for high-power and mid-range applications.

The CLA4609-000 thick base width mesa diode is designed for coarse limiter-stage applications.

Electrical and Mechanical Specifications

The absolute maximum ratings of the CLA diode series are specified in Table 1. Electrical specifications are provided in Table 2. Typical performance characteristics are provided in

Table 3 and Figures 1 through 4. Table 4 identifies the die part numbers with their corresponding top contact diameters and die outline drawings.

Table 1. CLA Series Absolute Maximum Ratings¹

| Parameter | Symbol | Min | Typ | Max | Units |
|-------------------------------------|------------------|-----|-----|--|-------|
| Power dissipation | P _{DIS} | | | $\frac{\text{Maximum } T_J - \text{Case Temp}}{\text{Thermal Resistance}_{\text{junction-to-case}}}$ | W |
| Reverse voltage | V _R | | | Minimum rated breakdown voltage | V |
| Forward current | I _F | | | 200 | mA |
| Junction temperature | T _J | -65 | | +175 | °C |
| Storage temperature | T _{STG} | -65 | | +200 | °C |
| Electrostatic discharge: | | | | | |
| Charged Device Model (CDM), Class 4 | | | | 1000 | V |
| Human Body Model (HBM), Class 1C | | | | 1000 | V |
| Machine Model (MM), Class A | | | | 150 | V |

¹ Exposure to maximum rating conditions for extended periods may reduce device reliability. There is no damage to device with only one parameter set at the limit and all other parameters set at or below their nominal value. Exceeding any of the limits listed here may result in permanent damage to the device.

ESD HANDLING: *Although this device is designed to be as robust as possible, electrostatic discharge (ESD) can damage this device. This device must be protected at all times from ESD when handling or transporting. Static charges may easily produce potentials of several kilovolts on the human body or equipment, which can discharge without detection. Industry-standard ESD handling precautions should be used at all times.*

Table 2. CLA Series Electrical Specifications^{1,2}

| Part Number | Breakdown Voltage (V) | I Region (μm) | Junction Capacitance (C _j) @ 0 V (pF) | Junction Capacitance (C _j) @ 6 V (pF) | Series Resistance (R _s) @ 10 mA (Ω) | Minority Carrier Lifetime (τ _L) @ 10 mA (ns) | Thermal Resistance (θ) ³ | | |
|-------------|-----------------------|---------------|---|---|---|--|-------------------------------------|------------------------------------|-----------------------|
| | | | | | | | Average (°C/W) | 1 μs Pulse 0.01% Duty Cycle (°C/W) | P _{DISS} (W) |
| | | | | | | | Min to Max | Nominal | Typical |
| CLA4601-000 | 15 to 30 | 1 | 0.12 | 0.10 | 2.5 | 5 | 185 | 0.89 | 0.49 |
| CLA4602-000 | 15 to 30 | 1 | 0.20 | 0.15 | 2.0 | 5 | 177 | 0.42 | 0.51 |
| CLA4603-000 | 20 to 45 | 1.5 | 0.20 | 0.15 | 2.0 | 5 | 135 | 0.39 | 0.66 |
| CLA4604-000 | 30 to 60 | 2.0 | 0.12 | 0.10 | 2.5 | 7 | 139 | 0.40 | 0.65 |
| CLA4605-000 | 30 to 60 | 2.0 | 0.20 | 0.15 | 2.0 | 7 | 139 | 0.51 | 0.65 |
| CLA4606-000 | 45 to 75 | 2.5 | 0.20 | 0.15 | 2.0 | 10 | 139 | 0.43 | 0.65 |
| CLA4607-000 | 120 to 180 | 7.0 | 0.20 | 0.15 @ 38 V | 2.0 | 50 | 191 | 0.26 | 0.47 |
| CLA4608-000 | 120 to 180 | 7.0 | 0.60 | 0.50 @ 38 V | 1.2 | 100 | 106 | 0.14 | 0.85 |
| CLA4609-000 | 250 (Min.) | 20 | 0.26 | 0.14 | 1.5 | 1175 | 84 | 0.44 | 1.07 |
| CLA4610-000 | 80 to 120 | 4.5 | 0.13 | 0.12 | 2.2 | 20 | 145 | 0.46 | 0.62 |
| CLA4611-000 | 120 to 180 | 12 | 0.23 | 0.20 @ 38 V | 1.2 | 300 | 103 | 0.37 | 0.87 |

¹ Performance is guaranteed only under the conditions listed in this table and is not guaranteed over the full operating or storage temperature ranges. Operation at elevated temperatures may reduce reliability of the device.

² T_{OP} = +25 °C, C_J measured at 1 MHz, R_S measured at 500 MHz, CW thermal resistance for infinite heat sink, unless otherwise noted.

³ Thermal resistance is calculated from the measured power dissipation and junction temperature @ f = 2.6 GHz, T_J max = 175 °C and T_{CASE} = 85 °C. Die were connected in single stage limiter configuration with a 22 nH inductor providing the DC ground return. The diode cathode was attached to the RF ground of a 10 mil thick Rogers 4003 microstrip test board using 2 mil thick conductive epoxy. The anode contact was connected to the test board input and output RF lines using 0.8 mil Au bond wire for each connection. The test board included 22 mil coplanar, gold-plated, RF lines and two 50 Ω SMA connectors.

Table 3. Typical Performance @ 25 °C @ 2.6 GHz, Z₀ = 50 Ω¹

| Part Number | Insertion Loss @ -10 dBm (dB) | CW Input Power for 1 dB Insertion Loss (dBm) | Maximum CW Input Power (dBm) | Maximum Pulsed Input Power (dBm) ² | Output @ Maximum Pulsed Input (dBm) ² | Recovery Time (ns) ³ | Spike Leakage (ergs) ⁴ |
|-------------|-------------------------------|--|------------------------------|---|--|---------------------------------|-----------------------------------|
| CLA4601-000 | 0.1 | 12 | 36 | 62 | 33 | 5 | Note 5 |
| CLA4602-000 | 0.1 | 12 | 36 | 64 | 37 | 5 | Note 5 |
| CLA4603-000 | 0.1 | 10 | 38 | 65 | 35 | 5 | Note 5 |
| CLA4604-000 | 0.1 | 12 | 40 | 64 | 36 | 5 | Note 5 |
| CLA4605-000 | 0.1 | 11 | 40 | 63 | 35 | 5 | 0.08 |
| CLA4606-000 | 0.1 | 11 | 41 | 64 | 36 | 5 | 0.03 |
| CLA4607-000 | 0.1 | 26 | 43 | 66 | 37 | 5 | 0.21 |
| CLA4608-000 | 0.2 | 23 | 43 | 69 | 39 | 5 | 0.15 |
| CLA4609-000 | 0.3 | 37 | 44 | 62 | 39 | 5 | 25.77 |
| CLA4610-000 | 0.1 | 22 | 40 | 65 | 34 | 5 | Note 5 |
| CLA4611-000 | 0.3 | 25 | 40 | 64 | 38 | 450 | 0.6 |

¹ Diode chip is mounted on a 0.5 oz Cu PC board using 1 to 2 mils of conductive epoxy. Bond wire connections are made with 0.8 mil Au wire. Limiter configured with shunt connected diode and 22 nH ground return and 100 pF DC blocking capacitors.

² Pulsed power measurements taken at 1 μs pulse width, pulse frequency = 10 kHz, and 0.01% duty cycle.

³ Recovery time represents the transition time from the high-loss state to the low-loss state following the removal of a high-power input. It is defined as the time from the end of the high-power pulse to the time when insertion loss has returned to within 3 dB of the quiescent (low-power) state.

⁴ Spike Leakage (ergs) = $t_s \times P_s \times 10^7$ where t_s is the spike width at the half-power point (in seconds) and P_s is the maximum spike amplitude in watts.

⁵ Not detectable under current test conditions described in Note 2.

Table 4. CLA Series Parts – Die Packages

| Part Number | Typical Top Contact Diameter (mils/mm) | Die Drawing |
|-------------|--|-------------|
| CLA4601-000 | 1.05/0.027 | 150-806 |
| CLA4602-000 | 1.15/0.029 | 150-806 |
| CLA4603-000 | 2.00/0.051 | 149-815 |
| CLA4604-000 | 1.65/0.042 | 150-806 |
| CLA4605-000 | 2.00/0.051 | 150-813 |
| CLA4606-000 | 2.25/0.057 | 149-815 |
| CLA4607-000 | 3.50/0.089 | 149-815 |
| CLA4608-000 | 6.50/0.165 | 149-815 |
| CLA4609-000 | 4.00/0.102 | 150-813 |
| CLA4610-000 | 2.75/0.070 | 149-815 |
| CLA4611-000 | 4.1/0.104 | 150-801 |

Typical Performance Characteristics
 (Tested at 25 °C, 2.6 GHz, Z₀ = 50 Ω)

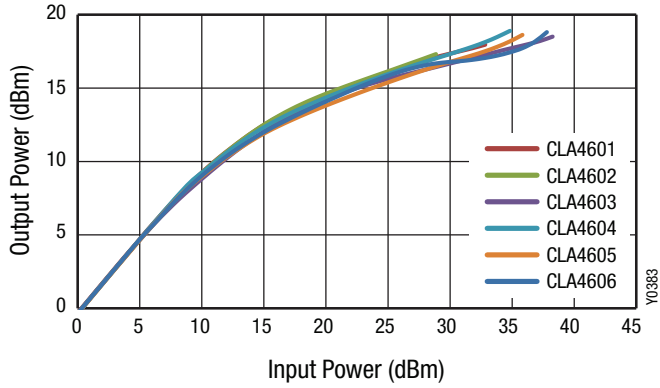

Figure 1. CLA4601 to CLA4606 CW Output vs Input Power

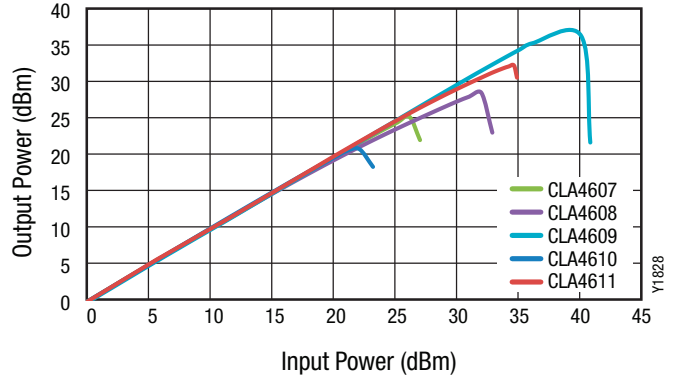

Figure 2. CLA4607 to CLA4611 CW Output vs Input Power

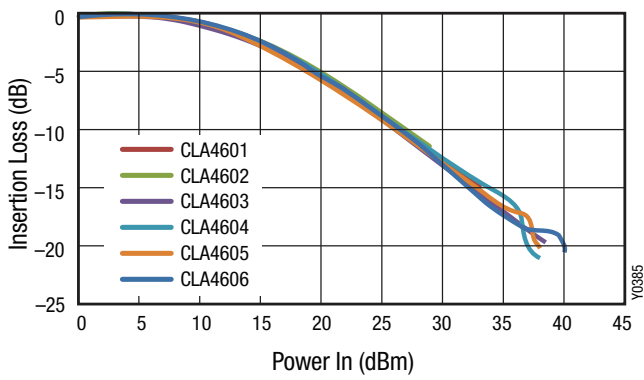

Figure 3. CLA4601 to CLA4606 Insertion Loss vs CW Input Power

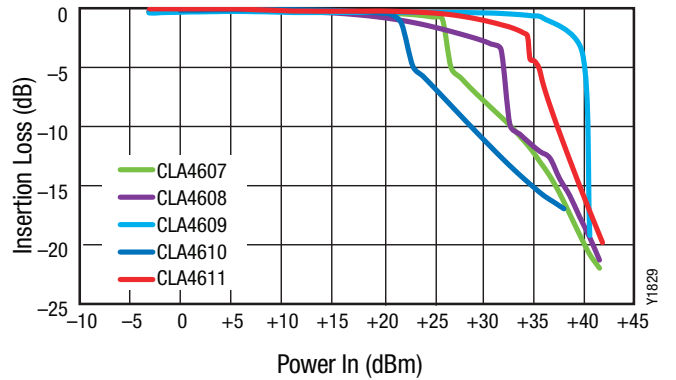

Figure 4. CLA4607 to CLA4611 Insertion Loss vs CW Input Power

Technical Description

The CLA4603-000, CLA4606-000 through CLA4608-000, and CLA4610-000 limiter diodes are constructed in a passivated flat-chip configuration and are available in a basic chip form.

Limiter diodes with lower capacitance values to 0.08 pF and constructed with a passivated mesa configuration are available in the CLA4601-000, CLA4602-000, CLA4604-000, CLA4605-000 and CLA4611-000 series. The mesa devices offer low capacitance and, therefore, broader bandwidth, lower loss, and faster response at reduced power. These diodes are also available

in chip form and represent the ultimate in limiter performance not approached by other manufacturers.

The highest power CLA4609 diodes use a mesa construction.

Additional bonding and handling methods are contained in these Skyworks Application Notes:

- *Waffle Pack Chip Carrier Handling/Opening Procedure* (document #200146)
- *Diode Chips, Beam-Lead Diodes, Capacitors: Bonding Methods and Packaging* (document #200532).

Package Outline Drawings

Package outline die drawings for the CLA diode series are shown in Figures 5, 6, and 7.

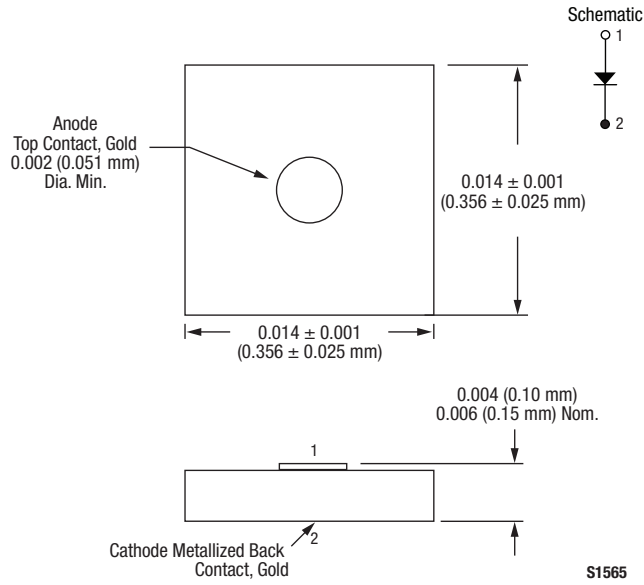

Figure 5. 149-815 Package

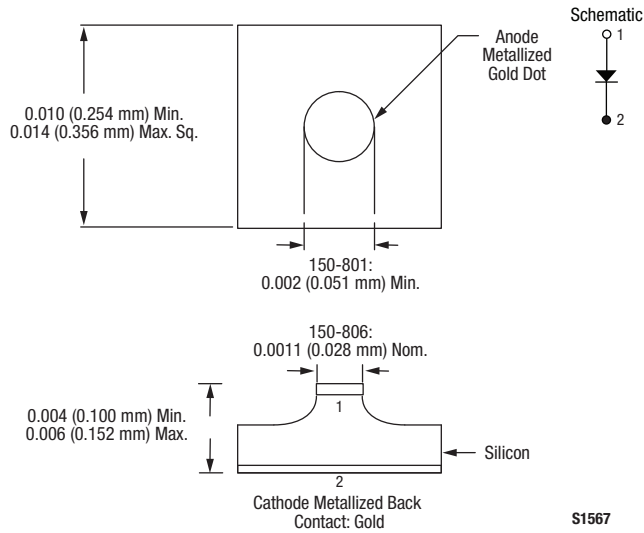
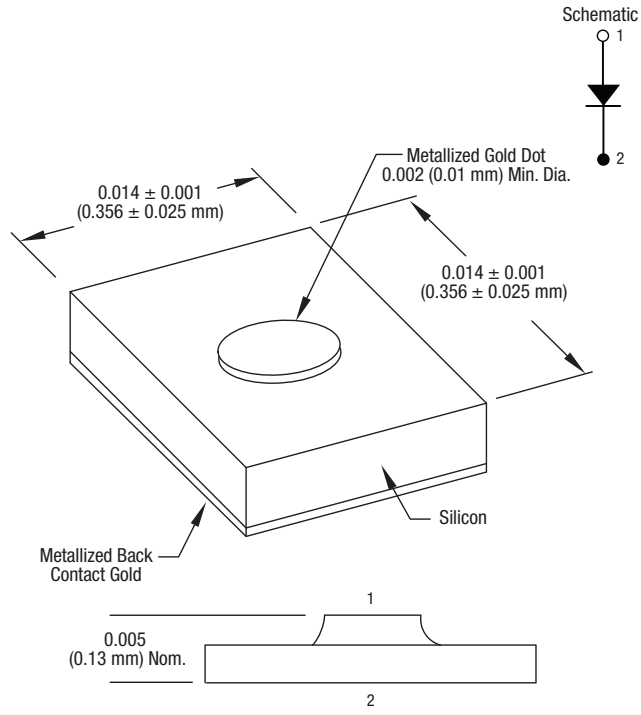

Figure 6. 150 Series Package



Dimensions are in inches (millimeters shown in parentheses)

S1566

Figure 7. 150-813 Package

DATA SHEET • CLA Series: Silicon Limiter Diode Bondable Chips

Copyright © 2002-2009, 2012-2015, 2020 Skyworks Solutions, Inc. All Rights Reserved.

Information in this document is provided in connection with Skyworks Solutions, Inc. ("Skyworks") products or services. These materials, including the information contained herein, are provided by Skyworks as a service to its customers and may be used for informational purposes only by the customer. Skyworks assumes no responsibility for errors or omissions in these materials or the information contained herein. Skyworks may change its documentation, products, services, specifications or product descriptions at any time, without notice. Skyworks makes no commitment to update the materials or information and shall have no responsibility whatsoever for conflicts, incompatibilities, or other difficulties arising from any future changes.

No license, whether express, implied, by estoppel or otherwise, is granted to any intellectual property rights by this document. Skyworks assumes no liability for any materials, products or information provided hereunder, including the sale, distribution, reproduction or use of Skyworks products, information or materials, except as may be provided in Skyworks Terms and Conditions of Sale.

THE MATERIALS, PRODUCTS AND INFORMATION ARE PROVIDED "AS IS" WITHOUT WARRANTY OF ANY KIND, WHETHER EXPRESS, IMPLIED, STATUTORY, OR OTHERWISE, INCLUDING FITNESS FOR A PARTICULAR PURPOSE OR USE, MERCHANTABILITY, PERFORMANCE, QUALITY OR NON-INFRINGEMENT OF ANY INTELLECTUAL PROPERTY RIGHT; ALL SUCH WARRANTIES ARE HEREBY EXPRESSLY DISCLAIMED. SKYWORKS DOES NOT WARRANT THE ACCURACY OR COMPLETENESS OF THE INFORMATION, TEXT, GRAPHICS OR OTHER ITEMS CONTAINED WITHIN THESE MATERIALS. SKYWORKS SHALL NOT BE LIABLE FOR ANY DAMAGES, INCLUDING BUT NOT LIMITED TO ANY SPECIAL, INDIRECT, INCIDENTAL, STATUTORY, OR CONSEQUENTIAL DAMAGES, INCLUDING WITHOUT LIMITATION, LOST REVENUES OR LOST PROFITS THAT MAY RESULT FROM THE USE OF THE MATERIALS OR INFORMATION, WHETHER OR NOT THE RECIPIENT OF MATERIALS HAS BEEN ADVISED OF THE POSSIBILITY OF SUCH DAMAGE.

Skyworks products are not intended for use in medical, lifesaving or life-sustaining applications, or other equipment in which the failure of the Skyworks products could lead to personal injury, death, physical or environmental damage. Skyworks customers using or selling Skyworks products for use in such applications do so at their own risk and agree to fully indemnify Skyworks for any damages resulting from such improper use or sale.

Customers are responsible for their products and applications using Skyworks products, which may deviate from published specifications as a result of design defects, errors, or operation of products outside of published parameters or design specifications. Customers should include design and operating safeguards to minimize these and other risks. Skyworks assumes no liability for applications assistance, customer product design, or damage to any equipment resulting from the use of Skyworks products outside of stated published specifications or parameters.

Skyworks and the Skyworks symbol are trademarks or registered trademarks of Skyworks Solutions, Inc. or its subsidiaries in the United States and other countries. Third-party brands and names are for identification purposes only and are the property of their respective owners. Additional information, including relevant terms and conditions, posted at www.skyworksinc.com, are incorporated by reference.