

## Features

- High Power
- Fast Speed
- Voltage Ratings to 1500 Volts
- Wide Selection of Carrier Lifetimes
- Wide Selection of Capacitances
- Assortment of Packages Styles
- Available Screened for Military Applications
- RoHS\* Compliant

## Description and Applications

MACOM's broad line of packaged PIN diodes encompass a comprehensive range of electrical characteristics and package outlines. This diverse union of semiconductor technology and chip packaging gives considerable flexibility to the circuit designer. The fast switching series of packaged PIN diodes utilize a thin I-region, silicon oxide or glass passivated chip which provides for low leakage current and low insertion loss.

With the use of in process control monitors to regulate wafer fabrication parameters, these devices will achieve consistent performance in control circuit applications. The high voltage product line of packaged PIN diodes employs MACOM CERMACHIP<sup>®</sup> passivation process which provides for a hard glass encapsulation that hermetically seals and protects the active area of the chip.

These packaged CERMACHIP<sup>®</sup> PIN diodes are ideally suited for use in high power applications where high level RF voltages are present. The diode chips are bonded into sealed ceramic packages that are designed for the most stringent electrical and environmental conditions. An extensive choice of package styles are available which may be used in a wide variety of RF microwave circuits.

The packaged PIN diodes series are designed to have a high inherent reliability and may be ordered screened to meet many MIL-STD requirements.

## Co-Axial Packages

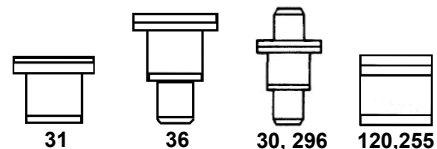

## Leaded/Surface Mount Packages

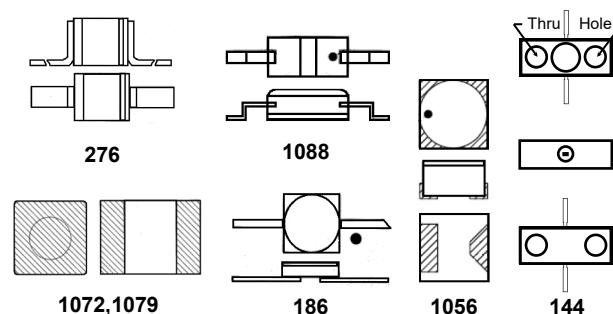

## Threaded Packages

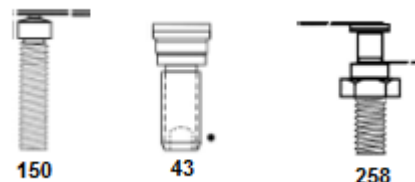

## Maximum Power Dissipation

| Package Style         | Absolute Maximum P <sub>DISS</sub>  |
|-----------------------|---|
| Cathode Heatsink      | $\frac{T}{T(\text{max. oper.}) - 25^\circ\text{C}}$<br>Thermal Resistance |
| Leaded @ +25°C        | 250 mW  |
| Surface Mount @ +25°C | 300 mW  |

\* Restrictions on Hazardous Substances, compliant to current RoHS EU directive.

## PIN Diodes Specifications ( $T_A = +25^\circ\text{C}$ )

### 100 to 250 V Fast Switching

| Part Number | Minimum Reverse Voltage <sup>2</sup> | Maximum Capacitance <sup>1</sup>             | Maximum Series Res.                            | Maximum Thermal Resistance | Nominal Characteristics       |                       |                |
|-------------|--------------------------------------|--|--|----------------------------|-------------------------------|-----------------------|----------------|
|             | @ $I_R < 10 \mu\text{A}$             | $C_T @ -10 \text{ V}$<br>$f = 1 \text{ MHz}$ | $R_S @ 10 \text{ mA}$<br>$f = 500 \text{ MHz}$ |                            | Carrier Lifetime <sup>5</sup> | $T_{RR}$ <sup>6</sup> | I-Region Width |
|             | V                                    | pF   | $\Omega$                                       |                            | $^\circ\text{C/W}$            | ns                    | ns             |
| MA4P202-120 | 100                                  | 0.25   | 2.50   | 60                         | 60                            | 5                     | 12             |
| MA4P203-30  | 100                                  | 0.35   | 1.50   | 30                         | 100                           | 20                    | 12             |
| MA4P303-36  | 200                                  | 0.35   | 1.50   | 30                         | 200                           | 60                    | 20             |
| MA4P404-30  | 250                                  | 0.40 <sup>3</sup>                            | 0.70 <sup>4</sup>                              | 20                         | 1000                          | 100                   | 30             |

1. Capacitance values shown are for the case style specified in the part number, other case style will result in different values.
2. The minimum specified  $V_R$  (Reverse Voltage) is sourced and the resultant reverse leakage current,  $I_R$ , is measured to be  $< 10 \mu\text{A}$
3. At  $V_R = -50 \text{ V}$
4.  $R_S$  measured at  $I_F = +50 \text{ mA}$ ,  $f = 100 \text{ MHz}$ .
5. Nominal carrier life time specified with diode biased at  $I_F = +10 \text{ mA}$ ,  $I_{REV} = -6 \text{ mA}$
6. Nominal  $T_{RR}$  (reverse recovery time) specified with diode biased at  $I_F = +20 \text{ mA}$ ,  $I_{REV} = -200 \text{ mA}$ .

### Package Options

Consult the "Package Availability Table" on page 7 for more package style choices.

### 35 to 500 V MELF General Purpose Switching

| Part Number <sup>7</sup> | Minimum Reverse Voltage <sup>8</sup> | Maximum Capacitance <sup>1</sup>             | Maximum Series Res.                            | CW Power Dissipation | Nominal Characteristics            |                               |                |
|--------------------------|--------------------------------------|--|--|----------------------|------------------------------------|-------------------------------|----------------|
|                          | @ $I_R < 10 \mu\text{A}$             | $C_T @ -10 \text{ V}$<br>$f = 1 \text{ MHz}$ | $R_S @ 10 \text{ mA}$<br>$f = 100 \text{ MHz}$ |                      | $I_F$ When<br>$R_S = 75 \text{ W}$ | Carrier Lifetime <sup>9</sup> | I-Region Width |
|                          | V                                    | pF   | $\Omega$                                       |                      | W                                  | mA                            | $\mu\text{s}$  |
| MA4PH235-1072T           | 35                                   | 1.2  | 0.50   | 7.5                  | —                                  | 0.3                           | 10             |
| MADP-000593-10720T       | 150                                  | 1.5  | 0.55   | 10.0                 | —                                  | 1.0                           | 20             |
| MA4PH236-1072T           | 600                                  | 0.5  | 3.0  | 3.75                 | —                                  | 1.5                           | 58             |
| MA4PH237-1079T           | 200                                  | 1.5  | 0.6 @ 50 mA                                    | 2.0                  | —                                  | 3.0                           | 50             |
| MA4PH238-1072T           | 200                                  | 0.5  | 6.0  | 1.0                  | 0.30-0.60                          | 2.0                           | 100            |
| MA4PH239-1079T           | 200                                  | 0.8  | 25.0   | 2.0                  | 1.20-2.40                          | 6.0                           | 370            |
| MADP-000234-10720T       | 500                                  | 1.5 <sup>10</sup>                            | 0.25 @ 100 mA                                  | 5.0                  | —                                  | 3.0                           | 50             |

7. Only available in case styles indicated.
8. The minimum specified  $V_R$  (Reverse Voltage) is sourced and the resultant reverse leakage current,  $I_R$ , is measured to be  $< 10 \mu\text{A}$ .
9. Nominal carrier life time specified with diode biased at  $I_F = +10 \text{ mA}$ ,  $I_{REV} = -6 \text{ mA}$
10.  $C_T$  tested at 100 V

**PIN Diodes Specifications (T<sub>A</sub> = +25°C)**

**500 V**

| Part Number                      | Minimum Reverse Voltage <sup>11</sup> | Maximum Capacitance <sup>1</sup>    | Maximum Series Res.                    | CW Power Dissipation | Nominal Characteristics        |                |
|----------------------------------|---------------------------------------|-------------------------------------|--|----------------------|--------------------------------|----------------|
|                                  | @ I <sub>R</sub> <10 μA               | C <sub>T</sub> @ 100 V<br>f = 1 MHz | R <sub>S</sub> @ 100 mA<br>f = 100 MHz |                      | Carrier Lifetime <sup>12</sup> | I-Region Width |
|                                  | V                                     | pF                                  | Ω                                      |                      | μs                             | μm             |
| MA4P504-30                       | 500                                   | 0.40                                | 0.60                                   | 10                   | 1                              | 40             |
| MADP-000015-000030 <sup>13</sup> | 500                                   | 0.55                                | 0.45                                   | 15                   | 2                              | 50             |
| MA4P506-30                       | 500                                   | 0.90                                | 0.30                                   | 15                   | 3                              | 50             |

11. The minimum specified VR (Reverse Voltage ) is sourced and the resultant reverse leakage current, I<sub>r</sub>, is measured to be <10 μA.

12. Nominal carrier life time specified with diode biased at I<sub>F</sub> = +10 mA , I<sub>REV</sub> = -6 mA

13. To order this part in a package style other than 30, use the prefix MA4P505 followed by a dash and the desired package style.

**Package Options**

**Consult the “Package Availability Table” on page 7 for more package style choices.**

**500 V MELF**

| Part Number   | Minimum Reverse Voltage <sup>14</sup> | Maximum Capacitance <sup>1</sup>    | Maximum Series Res.                    | CW Power Dissipation | Nominal Characteristics        |                |
|---------------|---------------------------------------|-------------------------------------|--|----------------------|--------------------------------|----------------|
|               | @ I <sub>R</sub> <10 μA               | C <sub>T</sub> @ 100 V<br>f = 1 MHz | R <sub>S</sub> @ 100 mA<br>f = 100 MHz |                      | Carrier Lifetime <sup>15</sup> | I-Region Width |
|               | V                                     | pF                                  | Ω                                      |                      | μs                             | μm             |
| MA4P505-1072T | 500                                   | 0.65                                | 0.45                                   | 15                   | 2                              | 50             |
| MA4P506-1072T | 500                                   | 1.0                                 | 0.30                                   | 15                   | 3                              | 50             |

14. The minimum specified VR (Reverse Voltage) is sourced and the resultant reverse leakage current, I<sub>r</sub>, is measured to be <10 μA.

15. Nominal carrier life time specified with diode biased at I<sub>F</sub> = +10 mA , I<sub>REV</sub> = -6 mA

**PIN Diodes Specifications ( $T_A = +25^\circ\text{C}$ )**

**1000 V CERMACHIP**

| Part Number | Minimum Reverse Voltage <sup>16</sup> | Maximum Capacitance <sup>1</sup>             | Maximum Series Res.                             | CW Power Dissipation | Nominal Characteristics        |                |
|-------------|---------------------------------------|--|---|----------------------|--------------------------------|----------------|
|             | @ $I_R < 10 \mu\text{A}$              | $C_T @ 100 \text{ V}$<br>$f = 1 \text{ MHz}$ | $R_S @ 100 \text{ mA}$<br>$f = 100 \text{ MHz}$ |                      | Carrier Lifetime <sup>17</sup> | I-Region Width |
|             | V                                     | pF   | $\Omega$  |                      | $\mu\text{s}$                  | $\mu\text{m}$  |
| MA4P604-30  | 1000                                  | 0.50   | 1.00  | 15                   | 3                              | 95             |
| MA4P606-30  | 1000                                  | 0.80   | 0.70  | 20                   | 4                              | 95             |
| MA4P607-43  | 1000                                  | 2.00   | 0.40  | 25                   | 12                             | 125            |

16. The maximum specified VR (reverse voltage) is sourced and the resultant reverse leakage current,  $I_r$ , is measured to be  $< 10 \mu\text{A}$ .

17. Nominal carrier life time specified with diode biased at  $I_F = +10 \text{ mA}$ ,  $I_{REV} = -6 \text{ mA}$ .

**Package Options**

**Consult the “Package Availability Table” on page 7 for more package style choices.**

**1500 V CERMACHIP**

| Part Number | Minimum Reverse Voltage <sup>18</sup> | Maximum Capacitance <sup>1</sup>             | Maximum Series Res.                             | Maximum Thermal Resistance | Nominal Characteristics        |                |
|-------------|---------------------------------------|--|---|----------------------------|--------------------------------|----------------|
|             | @ $I_R < 10 \mu\text{A}$              | $C_T @ 100 \text{ V}$<br>$f = 1 \text{ MHz}$ | $R_S @ 200 \text{ mA}$<br>$f = 100 \text{ MHz}$ |                            | Carrier Lifetime <sup>19</sup> | I-Region Width |
|             | V                                     | pF   | $\Omega$  |                            | $\mu\text{s}$                  | $\mu\text{m}$  |
| MA4P709-150 | 1500                                  | 3.30   | 0.25  | 2                          | 10                             | 200            |

18. The minimum specified VR (reverse voltage) is sourced and the resultant reverse leakage current,  $I_r$ , is measured to be  $< 10 \mu\text{A}$ .

19. Nominal carrier life time specified with diode biased at  $I_F = +10 \text{ mA}$ ,  $I_{REV} = -6 \text{ mA}$ .

Performance Curves @ 100 MHz

Forward Current vs. Series Resistance  
MA4P202, MA4P203, MA4P303 and MA4P404

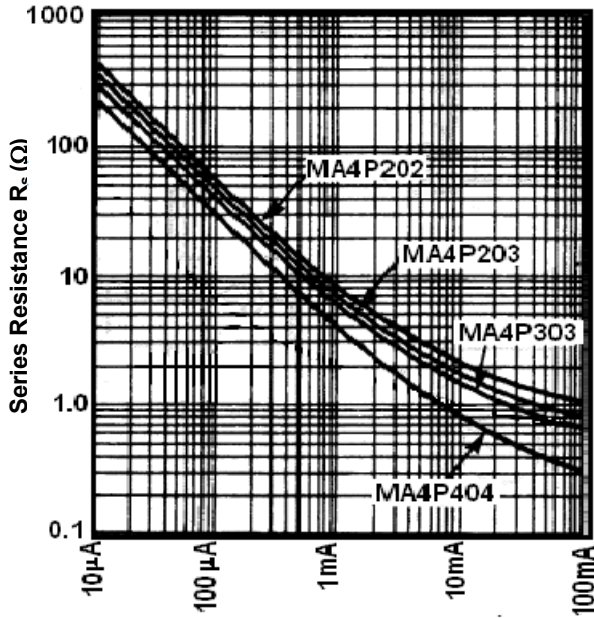

Forward Current vs. Series Resistance  
MA4P504, MA4P505 and MA4P506

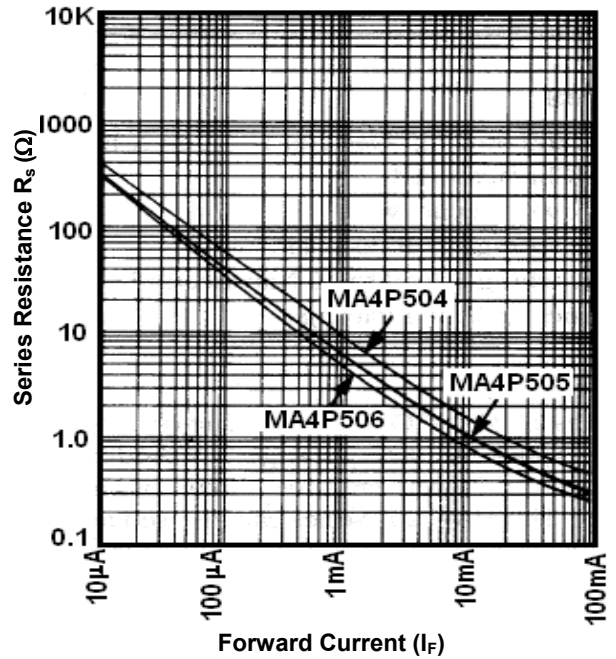

Forward Current vs. Series Resistance  
MA4P604, MA4P606 and MA4P607

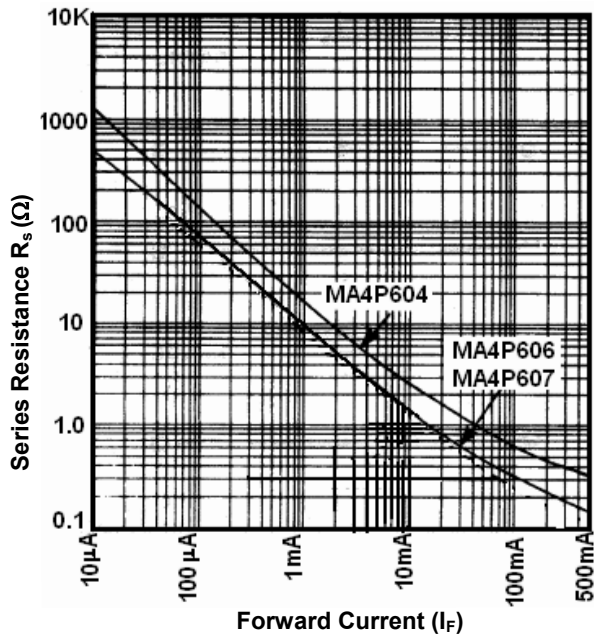

Forward Current vs. Series Resistance  
MA4P709

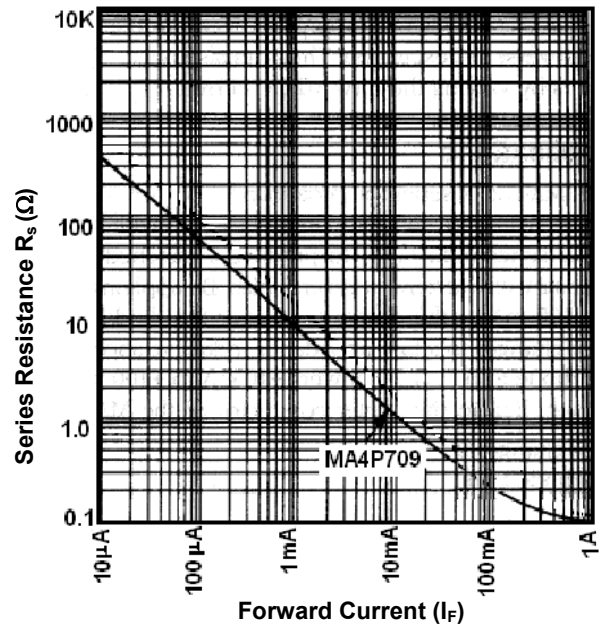

## Absolute Maximum Ratings<sup>20</sup>

| Parameter                               | Absolution Maximum    |
|---|-----------------------|
| Voltage                                 | As Specified in Table |
| Operating Temperature                   | -65°C to +175°C       |
| Storage Temperature                     | -65°C to +200°C       |
| Operating and Storage (Case Style 1088) | -65°C to +125°C       |

20. Exceeding any one or combination of these limits may cause permanent damage to this device.

## Maximum Soldering Temperature<sup>21,22</sup> (Hand soldering operation)

| Case Styles   | Maximum Temperature |
|---|---------------------|
| 120, 144, 150*, 186, 255, 258*, 276, 1088, 1072, 1079 | 265°C for 5 seconds |
| 30*, 31, 36*, 43*                                     | 225°C for 5 seconds |

21. Package styles (marked with an \*) that are threaded or have pronged ends rely on a pressure connection and do not require solder attachment but can be soldered if desired.  
 22. Refer to application note M538 on the MACOM website for solder reflow profiles.

## Recommended Groups B & C Testing Per MIL-STD 750

Recommended methods and conditions for Groups B, C and equivalent TX and TXV level screening.

| Inspection            | Method | Condition                   |
|-----------------------|--------|-----------------------------|
| Storage Temperature   | 1031   | See Maximum Ratings         |
| Operating Temperature | —      | See Maximum Ratings         |
| Temperature Cycling   | 1051   | 5 cycles<br>-65°C to +150°C |
| Shock                 | 2016   | 500 g's                     |
| Vibration             | 2056   | 15 g's                      |
| Constant Acceleration | 2006   | 20,000 g's                  |
| Humidity              | 1021   | 10 Days                     |

## Recommended Screening Per MIL-STD 750

Recommended methods and conditions for equivalent TX and TXV level screening.

| Inspection                     | Method     | Condition                          |
|--------------------------------|------------|------------------------------------|
| Internal Visual and / or X-Ray | 2072, 2076 | Notes 23,24                        |
| High Temperature Storage       | 1032       | 48 hours min. @ max. storage temp. |
| Thermal Shock                  | 1051       | 10 Cycles                          |
| Constant Acceleration          | 2006       | 20,000 g's, Y1                     |
| Fine Leak                      | 1071       | H                                  |
| Gross Leak                     | 1071       | C or E                             |
| Electrical                     | —          | Notes 22,23                        |
| Burn-In                        | 1038       | Notes 22,23                        |

23. Conditions and details of test depend on specific model number. Information available upon request.  
 24. Case styles 1056 and 1088 are not military, MIL-STD-750, rated packages.



## Ordering Information

The Packaged PIN Diode specifications shown in the tables on pages 2, 3, & 4 are for the standard style package. The standard package style is indicated by the number following the dash after the base part number. Note that the specification tables list the total diode capacitance for the standard case style. The total capacitance for the base part in an alternative package will differ and is computed by adding the junction capacitance of the chip and the parasitic capacitance of the alternative package as defined in the Package Parasitic Capacitance table.

To compute the chip junction capacitance, subtract the total capacitance shown in the specifications tables on pages 2, 3, & 4 from the appropriate standard style package capacitance below. The various base part numbers are only available in the case styles shown in the Package Availability Table below. To order, indicate the base part number followed by a dash and the desired package style.

*For example:* The MA4P506-258 is the MA4P506 chip in the 258 style package.

Other package styles not listed may be available by request at: [macom.com](http://macom.com)

## Package Availability Table<sup>25</sup>

| Base Part Number   | Available ODS Package Styles                   |
|--------------------|--|
| MA4P202            | 120, 276                                       |
| MA4P203            | 30, 1056                                       |
| MA4P303            | 120, 186, 1088                                 |
| MA4P404            | 30, 258,                                       |
| MA4P504            | 30, 120, 144, 186, 255, 1072T <sup>25,26</sup> |
| MA4P505            | 36, 255, 1072T <sup>25</sup>                   |
| MA4P506            | 30, 31, 255, 258, 1072T <sup>25</sup>          |
| MA4P604            | 30, 255, 258                                   |
| MA4P606            | 30, 36, 258                                    |
| MA4P607            | 43, 296  |
| MA4P709            | 150  |
| MADP-000015-000030 | 30   |
| MA4PH235           | 1072T <sup>25</sup>                            |
| MA4PH236           | 1072T <sup>25</sup>                            |
| MA4PH237           | 1079T <sup>25</sup>                            |
| MA4PH238           | 1072T <sup>25</sup>                            |
| MA4PH239           | 1079T <sup>25</sup>                            |
| MADP-000234        | 10720T <sup>25</sup>                           |

## Package Parasitic Capacitance

| Package Style | Cap. (pF) |
|---------------|-----------|
| 30            | 0.18      |
| 31            | 0.18      |
| 36            | 0.18      |
| 43            | 0.75      |
| 120           | 0.13      |
| 144           | 0.42      |
| 186           | 0.15      |
| 255           | 0.30      |
| 258           | 0.18      |
| 276           | 0.13      |
| 296           | 0.35      |
| 1056          | 0.20      |
| 1072          | 0.16      |
| 1079          | 0.13      |
| 1088          | 0.12      |

25. "T" after the package style number indicates tape and reel, refer to M513 for tape and reel information.

26. Datasheet for MA4P504-1072 can be found at: [macom.com](http://macom.com)

MACOM Technology Solutions Inc. ("MACOM"). All rights reserved.

These materials are provided in connection with MACOM's products as a service to its customers and may be used for informational purposes only. Except as provided in its Terms and Conditions of Sale or any separate agreement, MACOM assumes no liability or responsibility whatsoever, including for (i) errors or omissions in these materials; (ii) failure to update these materials; or (iii) conflicts or incompatibilities arising from future changes to specifications and product descriptions, which MACOM may make at any time, without notice. These materials grant no license, express or implied, to any intellectual property rights.

THESE MATERIALS ARE PROVIDED "AS IS" WITH NO WARRANTY OR LIABILITY, EXPRESS OR IMPLIED, RELATING TO SALE AND/OR USE OF MACOM PRODUCTS INCLUDING FITNESS FOR A PARTICULAR PURPOSE, MERCHANTABILITY, INFRINGEMENT OF INTELLECTUAL PROPERTY RIGHT, ACCURACY OR COMPLETENESS, OR SPECIAL, INDIRECT, INCIDENTAL, OR CONSEQUENTIAL DAMAGES WHICH MAY RESULT FROM USE OF THESE MATERIALS.

MACOM products are not intended for use in medical, lifesaving or life sustaining applications. MACOM customers using or selling MACOM products for use in such applications do so at their own risk and agree to fully indemnify MACOM for any damages resulting from such improper use or sale.