

DATA SHEET

TRANSIENT VOLTAGE SUPPRESSORS

AC/DC POWER SUPPLY

P6SMB-AT series

RoHS compliant & Halogen free



Product specification— June 30, 2023 V.4



Transient Voltage Suppressors (TVS) Data Sheet

Features

- For surface mounted applications in order to optimize board space
- Low profile package
- Built-in strain relief
- Glass passivated junction
- Low inductance
- Excellent clamping capability
- 600W peak pulse power capability at 10/1000 μ s waveform, repetition rate (duty cycle): 0.01%
- Fast response time
- Typical I_R less than 1 μ A above 12V
- High Temperature soldering: 260 $^{\circ}$ C/10 seconds at terminals
- Plastic package has underwriters laboratory flammability 94V-0
- Meets MSL level 1, per J-STD-020
- Safety certification: UL
- AEC-Q101 qualified
- IEC61000-4-2 ESD 30KV Air, 30KV contact compliance



Mechanical Data

- Case: JEDEC DO-214AA. Molded plastic over glass passivated junction
- Terminal: Tin plated, solderable per MIL-STD-750, Method 2026
- Polarity: Color band denotes cathode except bi-directional models
- Standard Packaging: 12mm tape (EIA STD RS-481)
- Weight: 0.10g

Applications

- I/O interface
- AC/DC power supply
- Low frequency signal transmission line (RS232, RS485, etc.)

Maximum Ratings and Characteristics

Ratings at 25 $^{\circ}$ C ambient temperature unless otherwise specified.

Rating	Symbol	Value	Units
Peak pulse power dissipation at 10/1000 μ s waveform (Note1, Note2, Fig.1)	P_{PPM}	Minimum 600	Watts
Peak pulse current of at 10/1000 μ s waveform (Note 1, Fig.3)	I_{PPM}	See Table	Amps
Steady state power dissipation at $T_A=50^{\circ}$ C (Fig.5)	$P_{M(AV)}$	5.0	Watts
Peak forward surge current, 8.3ms single half sine-wave superimposed on rated load, (JEDEC Method) (Note3, Fig.6)	I_{FSM}	100	Amps
Operating junction and Storage Temperature Range.	T_J, T_{STG}	-55 to +150	$^{\circ}$ C
Typical thermal resistance junction to lead	$R_{\theta JL}$	20	$^{\circ}$ C/W
Typical thermal resistance junction to ambient	$R_{\theta JA}$	100	$^{\circ}$ C/W

Notes: 1. Non-repetitive current pulse, per Fig.3 and derated above $T_A=25^{\circ}$ C per Fig.2.

2. Mounted on 5.0mm \times 5.0mm (0.03mm thick) copper pads to each terminal.

3. 8.3ms single half sine-wave, or equivalent square wave, duty cycle=4 pulses per minutes maximum.

Dimensions (SMB/DO-214AA)

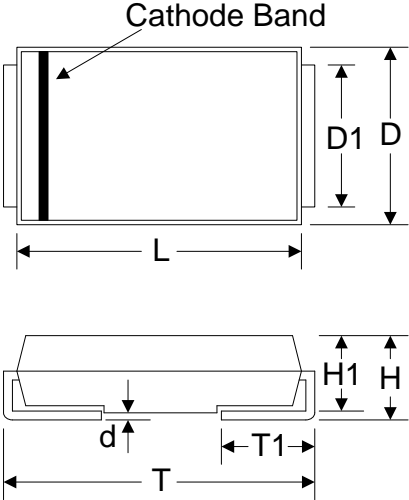
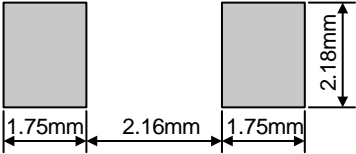
<p>Product:</p>  <p>Pad:</p> 	Symbol	Millimeters		Inches	
		Min.	Max.	Min.	Max.
	L	4.06	4.57	0.160	0.180
	D	3.30	3.94	0.130	0.155
	D1	1.95	2.20	0.077	0.086
	T	5.21	5.59	0.205	0.220
	T1	0.76	1.52	0.030	0.060
	d	-	0.203	-	0.008
	H	2.15	2.65	0.085	0.104
	H1	2.13	2.47	0.084	0.097

Electrical Characteristics (T_A=25°C)

Part Number		Device Marking Code		Reverse Stand-Off Voltage	Breakdown Voltage @I _T	Test Current	Maximum Clamping Voltage @I _{PP}	Peak Pulse Current	Reverse Leakage @V _{RWM}
Unidirectional	Bidirectional	UNI	BI	V _{RWM} (V)	V _{BR} (V)	I _T (mA)	V _C (V)	I _{PP} (A)	I _R (μA)
P6SMB6.8A-AT	P6SMB6.8CA-AT	6V8A	6V8C	5.80	6.45~7.14	10	10.5	58.1	1000
P6SMB7.5A-AT	P6SMB7.5CA-AT	7V5A	7V5C	6.40	7.13~7.88	10	11.3	54.0	500
P6SMB8.2A-AT	P6SMB8.2CA-AT	8V2A	8V2C	7.02	7.79~8.61	10	12.1	50.4	200
P6SMB9.1A-AT	P6SMB9.1CA-AT	9V1A	9V1C	7.78	8.65~9.55	1	13.4	45.5	50
P6SMB10A-AT	P6SMB10CA-AT	10A	10C	8.55	9.50~10.50	1	14.5	42.1	10
P6SMB11A-AT	P6SMB11CA-AT	11A	11C	9.40	10.50~11.60	1	15.6	39.1	5
P6SMB12A-AT	P6SMB12CA-AT	12A	12C	10.20	11.40~12.60	1	16.7	36.5	5
P6SMB13A-AT	P6SMB13CA-AT	13A	13C	11.10	12.40~13.70	1	18.2	33.5	1
P6SMB15A-AT	P6SMB15CA-AT	15A	15C	12.80	14.30~15.80	1	21.2	28.8	1
P6SMB16A-AT	P6SMB16CA-AT	16A	16C	13.60	15.20~16.80	1	22.5	27.1	1
P6SMB18A-AT	P6SMB18CA-AT	18A	18C	15.30	17.10~18.90	1	25.2	24.2	1
P6SMB20A-AT	P6SMB20CA-AT	20A	20C	17.10	19.00~21.00	1	27.7	22.0	1
P6SMB22A-AT	P6SMB22CA-AT	22A	22C	18.80	20.90~23.10	1	30.6	19.9	1
P6SMB24A-AT	P6SMB24CA-AT	24A	24C	20.50	22.80~25.20	1	33.2	18.4	1
P6SMB27A-AT	P6SMB27CA-AT	27A	27C	23.10	25.70~28.40	1	37.5	16.3	1

Transient Voltage Suppressors

P6SMB-AT

Part Number		Device Marking Code		Reverse Stand-Off Voltage	Breakdown Voltage @I _T	Test Current	Maximum Clamping Voltage @I _{PP}	Peak Pulse Current	Reverse Leakage @V _{RWM}
Unidirectional	Bidirectional	UNI	BI	V _{RWM} (V)	V _{BR} (V)	I _T (mA)	V _C (V)	I _{PP} (A)	I _R (μA)
P6SMB30A-AT	P6SMB30CA-AT	30A	30C	25.60	28.50~31.50	1	41.4	14.7	1
P6SMB33A-AT	P6SMB33CA-AT	33A	33C	28.20	31.40~34.70	1	45.7	13.3	1
P6SMB36A-AT	P6SMB36CA-AT	36A	36C	30.80	34.20~37.80	1	49.9	12.2	1
P6SMB39A-AT	P6SMB39CA-AT	39A	39C	33.30	37.10~41.00	1	53.9	11.3	1
P6SMB43A-AT	P6SMB43CA-AT	43A	43C	36.80	40.90~45.20	1	59.3	10.3	1
P6SMB47A-AT	P6SMB47CA-AT	47A	47C	40.20	44.70~49.40	1	64.8	9.4	1
P6SMB51A-AT	P6SMB51CA-AT	51A	51C	43.60	48.50~53.60	1	70.1	8.7	1
P6SMB56A-AT	P6SMB56CA-AT	56A	56C	47.80	53.20~58.80	1	77.0	7.9	1
P6SMB62A-AT	P6SMB62CA-AT	62A	62C	53.00	58.90~65.10	1	85.0	7.2	1
P6SMB68A-AT	P6SMB68CA-AT	68A	68C	58.10	64.60~71.40	1	92.0	6.6	1
P6SMB75A-AT	P6SMB75CA-AT	75A	75C	64.10	71.30~78.80	1	103.0	5.9	1
P6SMB82A-AT	P6SMB82CA-AT	82A	82C	70.10	77.90~86.10	1	113.0	5.4	1
P6SMB91A-AT	P6SMB91CA-AT	91A	91C	77.80	86.50~95.50	1	125.0	4.9	1
P6SMB100A-AT	P6SMB100CA-AT	100A	100C	85.50	95.00~105.00	1	137.0	4.5	1
P6SMB110A-AT	P6SMB110CA-AT	110A	110C	94.00	105.00~116.00	1	152.0	4.0	1
P6SMB120A-AT	P6SMB120CA-AT	120A	120C	102.00	114.00~126.00	1	165.0	3.7	1
P6SMB130A-AT	P6SMB130CA-AT	130A	130C	111.00	124.00~137.00	1	179.0	3.4	1
P6SMB150A-AT	P6SMB150CA-AT	150A	150C	128.00	143.00~158.00	1	207.0	2.9	1
P6SMB160A-AT	P6SMB160CA-AT	160A	160C	136.00	152.00~168.00	1	219.0	2.8	1
P6SMB170A-AT	P6SMB170CA-AT	170A	170C	145.00	162.00~179.00	1	234.0	2.6	1
P6SMB180A-AT	P6SMB180CA-AT	180A	180C	154.00	171.00~189.00	1	246.0	2.5	1
P6SMB200A-AT	P6SMB200CA-AT	200A	200C	171.00	190.00~210.00	1	274.0	2.2	1
P6SMB220A-AT	P6SMB220CA-AT	220A	220C	185.00	209.00~231.00	1	328.0	1.9	1
P6SMB250A-AT	P6SMB250CA-AT	250A	250C	214.00	237.00~263.00	1	344.0	1.8	1
P6SMB300A-AT	P6SMB300CA-AT	300A	300C	256.00	285.00~315.00	1	414.0	1.5	1
P6SMB350A-AT	P6SMB350CA-AT	350A	350C	300.00	332.00~368.00	1	482.0	1.3	1
P6SMB400A-AT	P6SMB400CA-AT	400A	400C	342.00	380.00~420.00	1	548.0	1.1	1
P6SMB440A-AT	P6SMB440CA-AT	440A	440C	376.00	418.00~462.00	1	602.0	1.0	1
P6SMB480A-AT	P6SMB480CA-AT	480A	480C	408.00	456.00~504.00	1	658.0	0.9	1
P6SMB510A-AT	P6SMB510CA-AT	510A	510C	434.00	485.00~535.00	1	698.0	0.9	1
P6SMB530A-AT	P6SMB530CA-AT	530A	530C	450.00	503.50~556.50	1	725.0	0.8	1
P6SMB540A-AT	P6SMB540CA-AT	540A	540C	459.00	513.00~567.00	1	740.0	0.8	1
P6SMB550A-AT	P6SMB550CA-AT	550A	550C	467.00	522.50~577.50	1	760.0	0.8	1
P6SMB600A-AT	P6SMB600CA-AT	600A	600C	510.00	570.00~630.00	1	828.0	0.75	1

Ratings and Characteristic Curves ($T_A=25^\circ\text{C}$ unless otherwise noted)

Figure 1. Peak Pulse Power Rating Curve

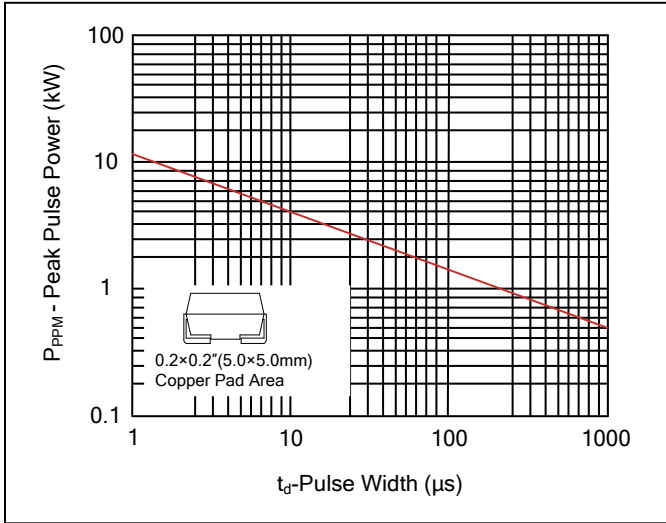

Figure 2. Pulse Derating Curve

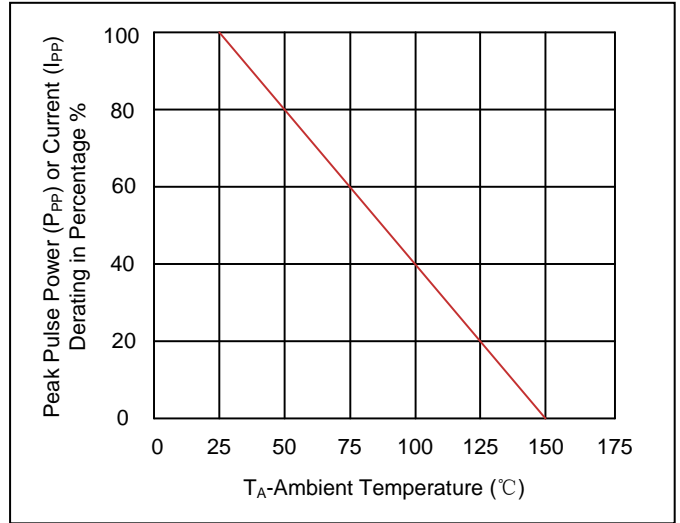

Figure 3. Pulse Waveform

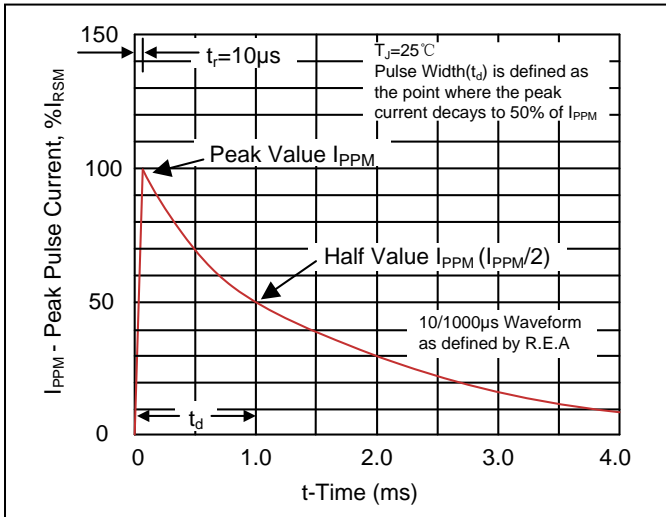

Figure 4. Typical Junction Capacitance

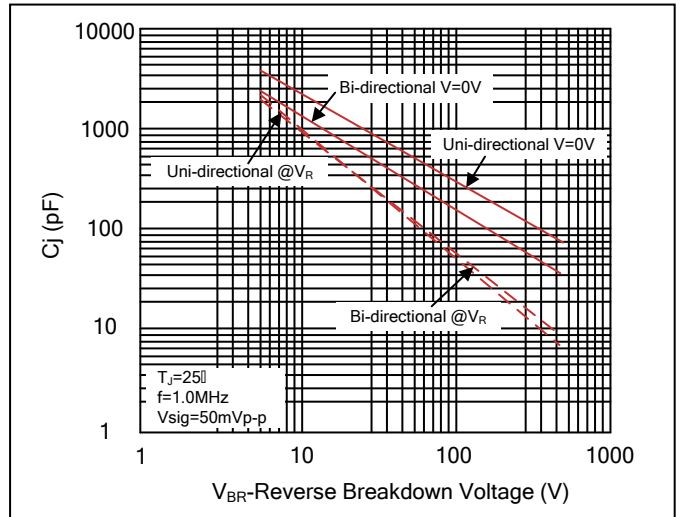

Figure 5. Steady State Power Dissipation Derating Curve

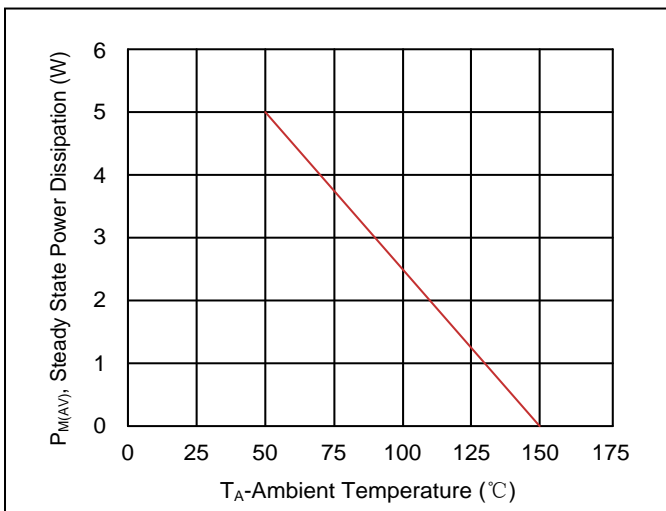
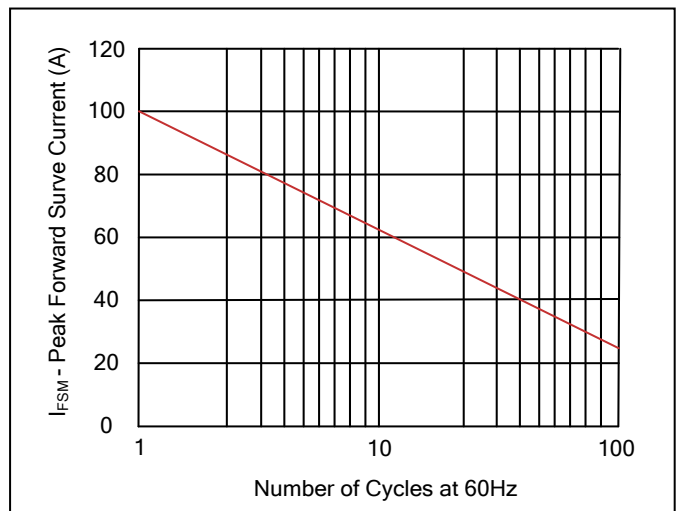
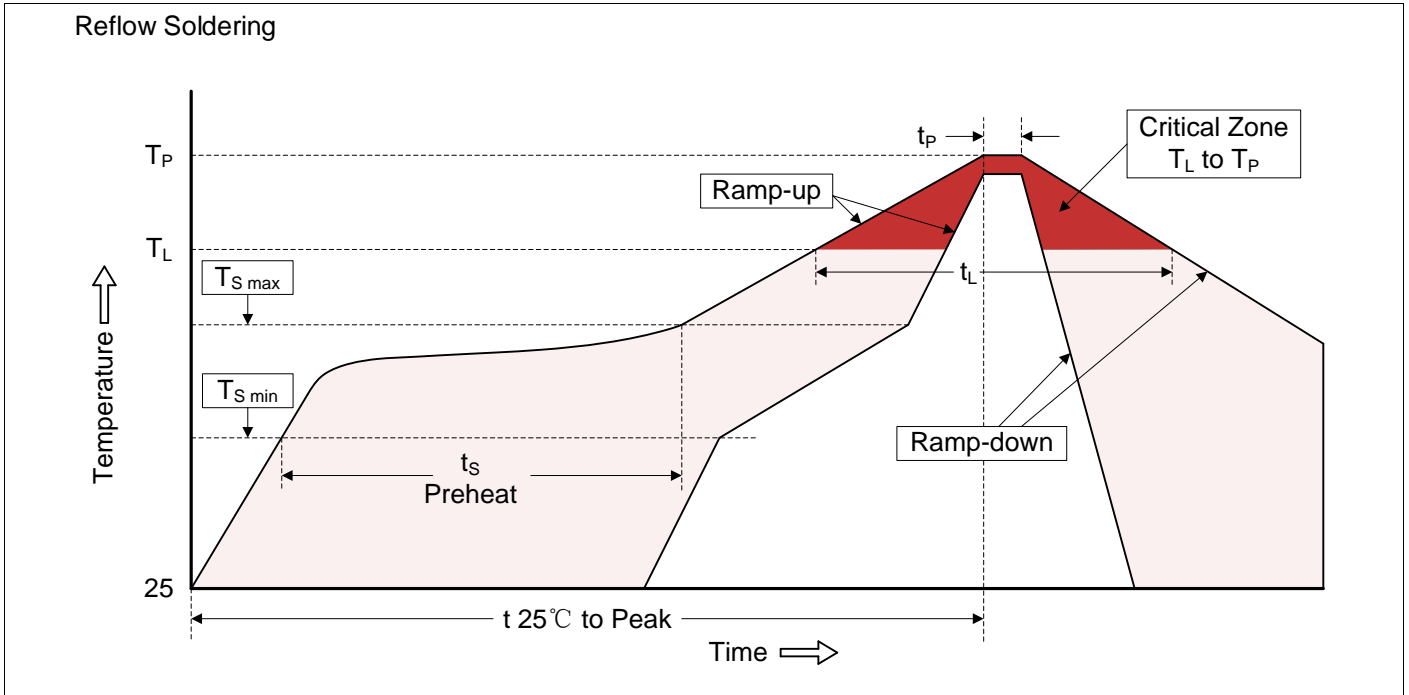

Figure 6. Maximum Non-Repetitive Forward Surge Current Uni-Directional Only



Recommended Soldering Conditions



Recommended Conditions

Profile Feature	Pb-Free Assembly
Average ramp-up rate (T _L to T _P)	3°C/second max.
Preheat	
-Temperature Min (T _{S min})	150°C
-Temperature Max (T _{S max})	200°C
-Time (min to max) (t _s)	60-180 seconds
T _{S max} to T _L	
-Ramp-up Rate	3°C/second max.
Time maintained above:	
-Temperature (T _L)	217°C
-Time (t _L)	60-150 seconds
Peak Temperature (T _P)	260°C
Time within 5°C of actual Peak Temperature (t _P)	20-40 seconds
Ramp-down Rate	6°C/second max.
Time 25°C to Peak Temperature	8 minutes max.

Marking Code

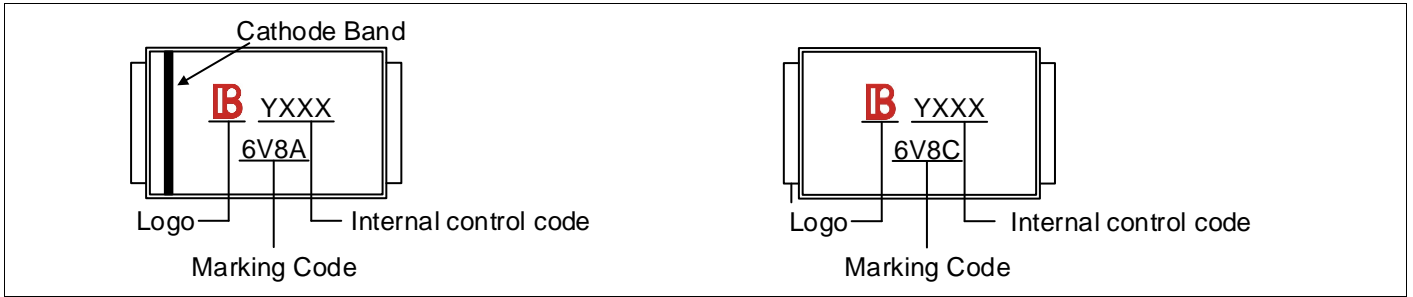

Part Number Code

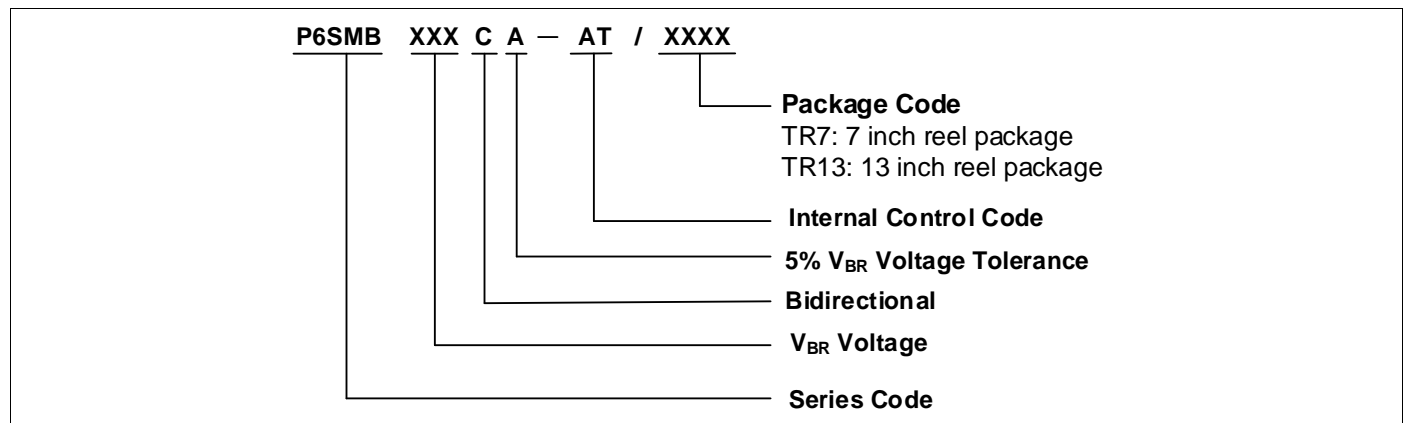

Ordering Code for Different Package

7 inch reel package: Add suffix “ /TR7 ” at the end of the part number, such as P6SMBXXXCA-AT/TR7

13 inch reel package: Add suffix “ /TR13 ” at the end of the part number, such as P6SMBXXXCA-AT/TR13

Packaging

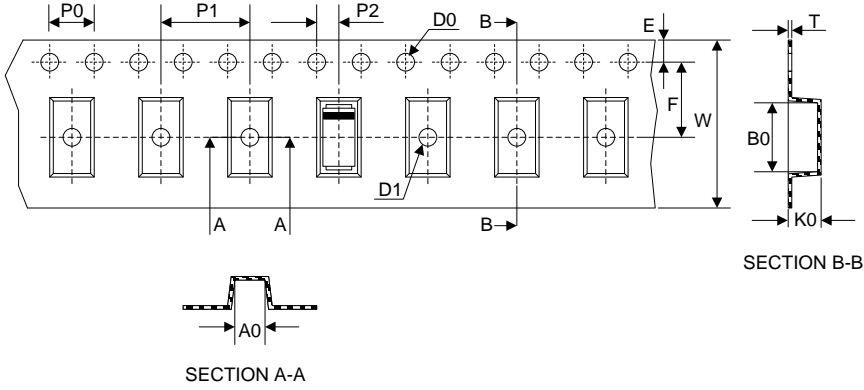
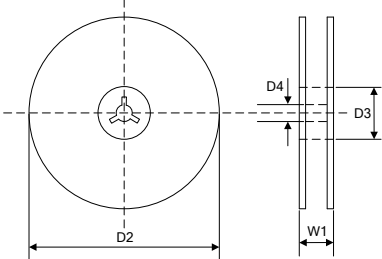
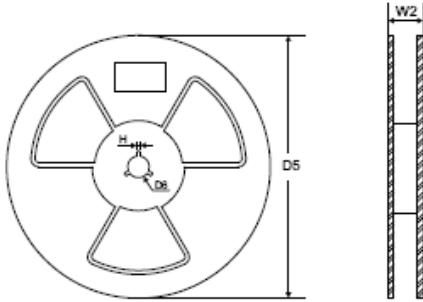
Tape	Symbol	Dimension (mm)	
	W	12.00±0.20	
	P0	4.00±0.10	
	P1	8.00±0.10	
	P2	2.00±0.10	
	D0	Φ1.55±0.10	
	D1	Φ1.5±0.10	
	E	1.75±0.10	
	F	5.50±0.10	
	A0	3.86±0.15	
	B0	5.65±0.10	
	K0	2.75±0.15	
	T	0.25±0.05	
	<p>7" Reel</p> 	D2	Φ178.0±2.0
		D3	Φ50.0Min.
D4		Φ13.0±0.5	
W1		16.0±2.0	
Quantity: 500PCS			
<p>13" Reel</p> 	D5	Φ330.0±2.0	
	D6	Φ13.5±0.5	
	H	2.5±1.0	
	W2	16.0±2.0	
	Quantity: 3000PCS		

LEGAL DISCLAIMER

YAGEO, its distributors and agents (collectively, "YAGEO"), hereby disclaims any and all liabilities for any errors, inaccuracies or incompleteness contained in any product related information, including but not limited to product specifications, datasheets, pictures and/or graphics. YAGEO may make changes, modifications and/or improvements to product related information at any time and without notice.

YAGEO makes no representation, warranty, and/or guarantee about the fitness of its products for any particular purpose or the continuing production of any of its products. To the maximum extent permitted by law, YAGEO disclaims (i) any and all liability arising out of the application or use of any YAGEO product, (ii) any and all liability, including without limitation special, consequential or incidental damages, and (iii) any and all implied warranties, including warranties of fitness for a particular purpose, non-infringement and merchantability.

YAGEO products are designed for general purpose applications under normal operation and usage conditions. Please contact YAGEO for the applications listed below which require especially high reliability for the prevention of defects which might directly cause damage to the third party's life, body or property: Aerospace equipment (artificial satellite, rocket, etc.), Atomic energy-related equipment, Aviation equipment, Disaster prevention equipment, crime prevention equipment, Electric heating apparatus, burning equipment, Highly public information network equipment, data-processing equipment, Medical devices, Military equipment, Power generation control equipment, Safety equipment, Traffic signal equipment, Transportation equipment and Undersea equipment, or for any other application or use in which the failure of YAGEO products could result in personal injury or death, or serious property damage. Particularly **YAGEO Corporation and its affiliates do not recommend the use of commercial or automotive grade products for high reliability applications or manned space flight.**

Information provided here is intended to indicate product specifications only. YAGEO reserves all the rights for revising this content without further notification, as long as products are unchanged. Any product change will be announced by PCN.