

Ultra Low Capacitance Diode Arrays Series

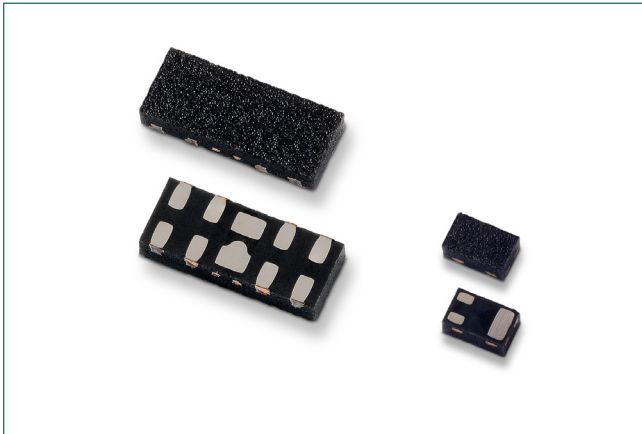

Pinout

0402 DFN array

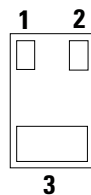

1004 DFN array

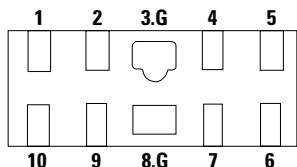

Functional Block Diagram

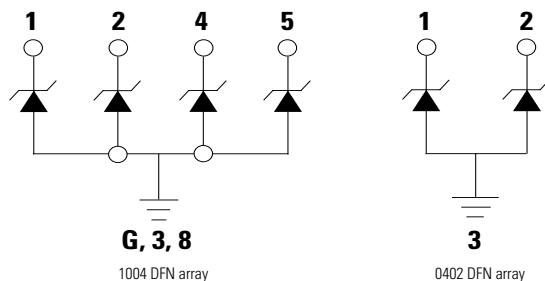

Description

This Ultra Low Capacitance Diode Arrays Series provides signal integrity-preserving unidirectional ESD protection for the world's most challenging high speed serial interfaces. The SOD 883 and the standard 2.4 mm x 1.0 mm packaging options provide significant PCB layout space savings and reduces trace layout complexity. This component provides both air and contact ESD protection (IEC 61000-4-2) of 20 kV while maintaining an extremely low leakage current and low dynamic resistance. Due to its low off-state capacitance, this series is compatible with high speed interfaces and thus maintains high bandwidth signal integrity.

Features & Benefits

- 0.20 pF TYP capacitance
- ESD, IEC 61000-4-2, ± 20 kV contact, ± 20 kV air
- Low clamping voltage of 9.2V @ IPP=2.0A (tP=8/20 μ s)
- Low profile DFN array packages
- Facilitates excellent signal integrity
- ELV Compliant
- Halogen free, Lead free and RoHS compliant
- AEC-Q101 qualified

Applications

- USB 3.1, 3.0, 2.0
- HDMI 2.0, 1.4a, 1.3
- DisplayPort(TM)
- V-by-One®
- Thunderbolt (Light Peak)
- LVDS interfaces
- Consumer, mobile and portable electronics
- Tablet PC and external storage with high speed interfaces
- Applications requiring high ESD performance in small packages

Ultra Low Capacitance Diode Arrays Series

Absolute Maximum Ratings

Symbol	Parameter	Value	Units
I_{PP}	Peak Current ($t_p=8/20\mu s$)	2.0	A
T_{OP}	Operating Temperature	-40 to 125	°C
T_{STOR}	Storage Temperature	-55 to 150	°C

Caution: Stresses above those listed in "Absolute Maximum Ratings" may cause permanent damage to the component. This is a stress only rating and operation of the component at these or any other conditions above those indicated in the operational sections of this specification is not implied.

Electrical Characteristics - ($T_{OP}=25^\circ C$)

Parameter	Test Conditions	Min	Typ	Max	Units
Input Capacitance	@ $V_R = 0V$, $f = 3GHz$		0.20	0.22	pF
Breakdown Voltage	V_{BR} @ $I_T=1mA$		9.00		V
Reverse Working Voltage				7.0	V
Reverse Leakage Current	I_L @ $V_{RWM}=5.0V$		25	50	nA
Clamping Voltage	V_{CL} @ $I_{PP}=2.0A$		9.20		V
Peak Pulse Current	$t_p=8/20\mu s$			2.0	A
ESD Withstand Voltage	IEC 61000-4-2 (Contact)	± 20			kV
	IEC 61000-4-2 (Air)	± 20			

Insertion Loss Diagram

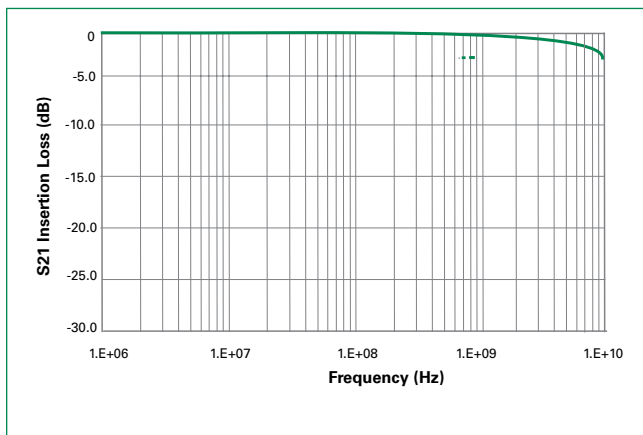

Device IV Curve

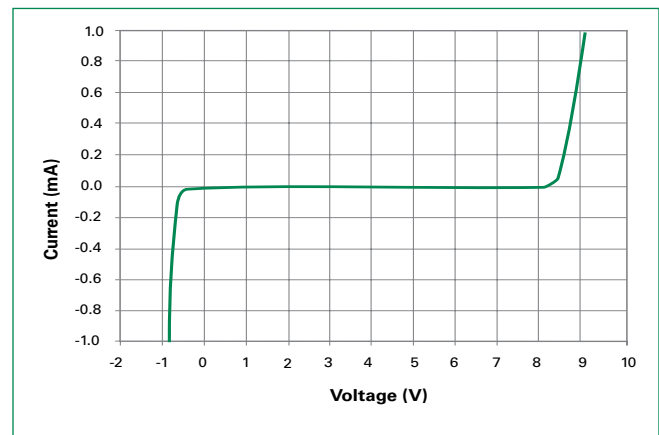

TLP

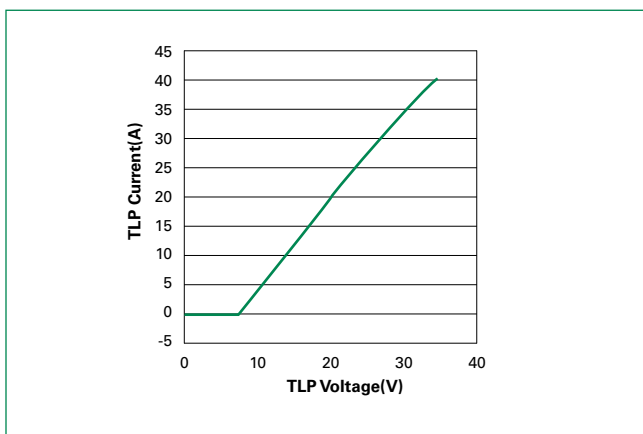

Ultra Low Capacitance Diode Arrays Series

USB3.0 Eye Diagram

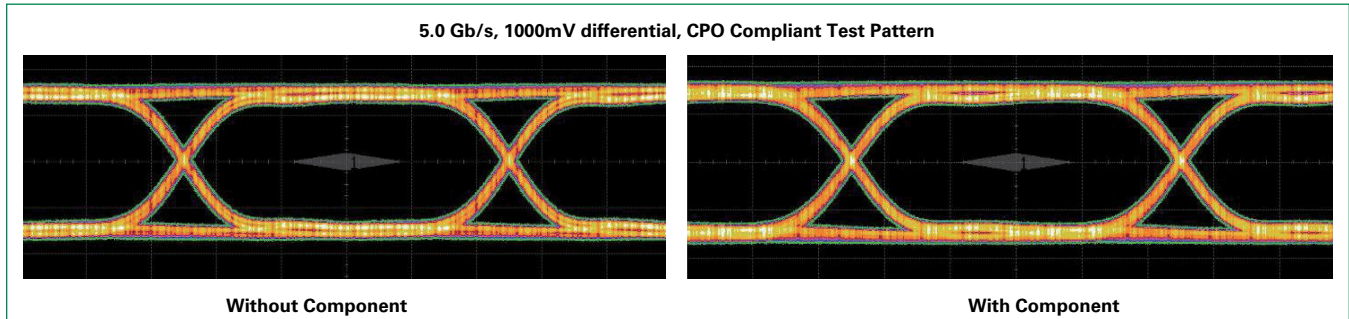

Soldering Parameters

Reflow Condition	Pb – Free assembly	
Pre Heat	- Temperature Min ($T_{s(min)}$)	150°C
	- Temperature Max ($T_{s(max)}$)	200°C
	- Time (min to max) (t_p)	60 – 120 secs
Average ramp up rate (Liquidus) Temp (T_L) to peak	3°C/second max	
$T_{s(max)}$ to T_L - Ramp-up Rate	3°C/second max	
Reflow	- Temperature (T_L) (Liquidus)	217°C
	- Temperature (t_L)	60 – 150 seconds
Peak Temperature (T_p)	260 ^{+0/-5} °C	
Time within 5°C of actual peak Temperature (t_p)	30 seconds	
Ramp-down Rate	6°C/second max	
Time 25°C to peak Temperature (T_p)	8 minutes Max.	
Do not exceed	260°C	

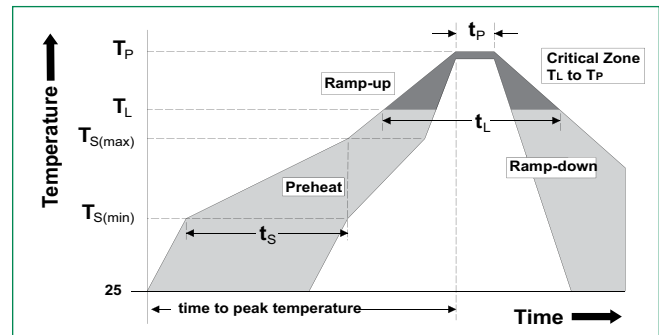

Product Characteristics of 0402 DFN Package

Lead Plating	Pre-Plated Frame
Lead Material	Copper Alloy
Lead Coplanarity	0.004 inches(0.102mm)
Substrate material	Silicon
Body Material	Molded Epoxy
Flammability	UL Recognized epoxy meeting flammability rating V-0

Notes :

1. All dimensions are in millimeters
2. Dimensions include solder plating.
3. Dimensions are exclusive of mold flash & metal burr.
4. Blo is facing up for mold and facing down for trim/form, i.e. reverse trim/form.
5. Package surface matte finish VDI 11-13.

Part Marking System

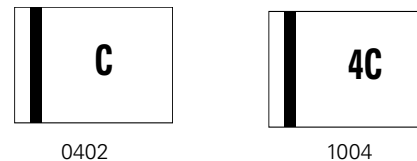

Notes :

For markings see Ordering Information table below

Part Numbering System

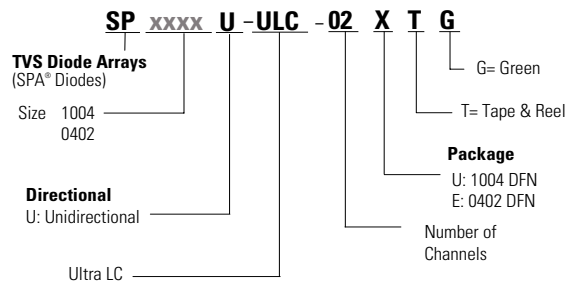

Ordering Information

Part Number	Package	Reel Quantity
SP0402U-ULC-02ETG	0402 DFN Array	10000
SP1004U-ULC-04UTG	1004 DFN Array	3000

Ultra Low Capacitance Diode Arrays Series

Package Dimensions – 0402 DFN Array

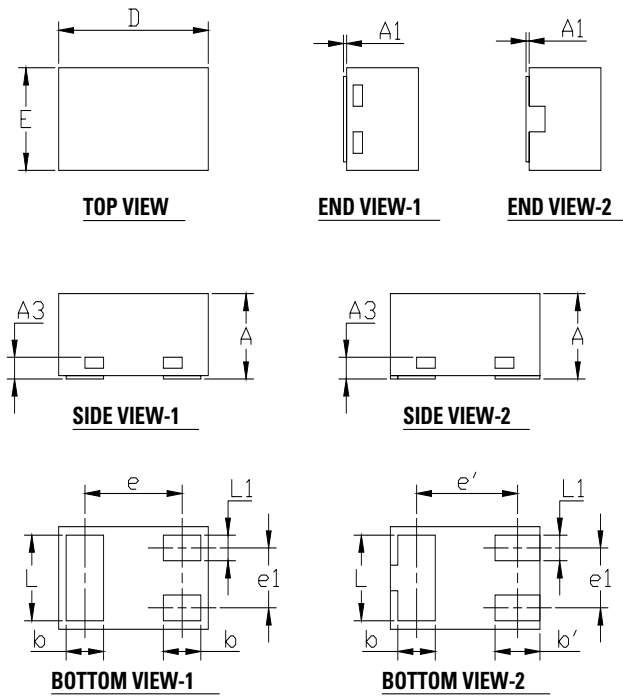

Symbol	Millimeters			Inches		
	Min	Typ	Max	Min	Typ	Max
A	0.33	-	0.55	0.013	0.015	0.022
A1	0	-	0.05	0	-	0.002
A3	0.13REF			0.005REF		
b	0.20	0.25	0.30	0.008	0.010	0.012
b'	0.20	0.30	0.40	0.008	0.012	0.016
D	0.95	1.00	1.05	0.037	0.039	0.041
E	0.55	0.60	0.65	0.022	0.024	0.026
e	0.65BSC			0.026BSC		
e'	0.675BSC			0.027BSC		
L	0.40	0.50	0.60	0.016	0.020	0.024
L1	0.10	0.15	0.20	0.004	0.006	0.008

SOLDERING PATTERN

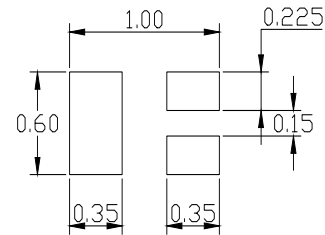

Embossed Carrier Tape & Reel Specification – 0402 DFN Array

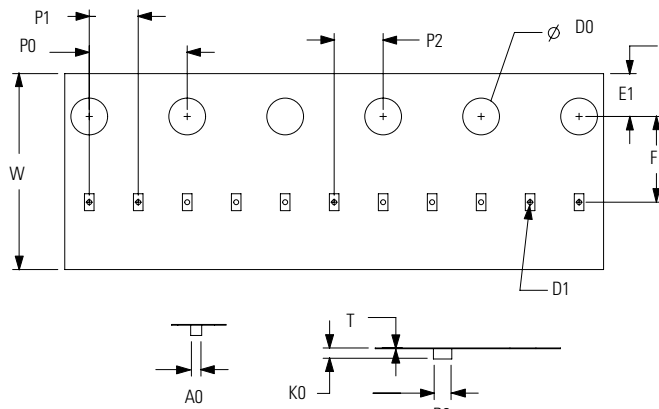

Symbol	Millimeters
A0	0.70+/-0.05
B0	1.15+/-0.05
D0	ø 1.50+/-0.10
D1	ø 0.40 +/-0.10
E1	1.75+/-0.10
F	3.50+/-0.10
K0	0.55+/-0.05
P0	4.00+/-0.10
P1	2.00+/-0.10
P2	2.00+/-0.05
W	8.00+0.30/-0.10
T	0.20+/-0.05

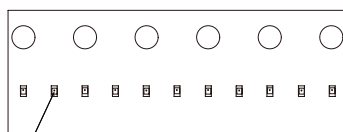

Ultra Low Capacitance Diode Arrays Series

Package Dimensions — 1004 DFN Array

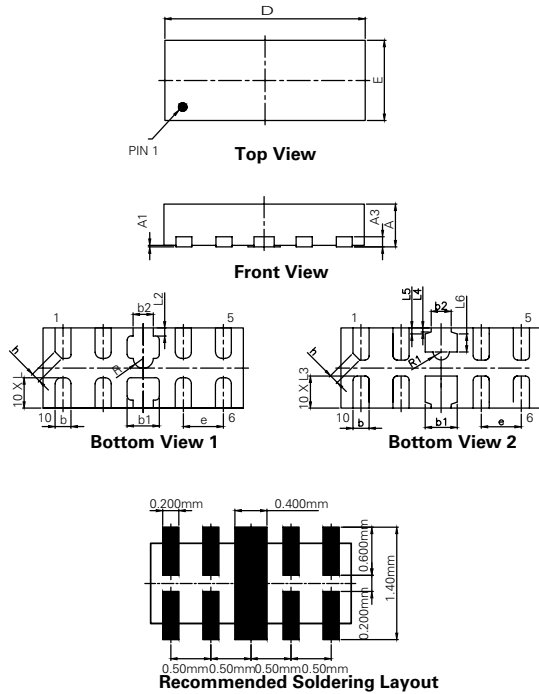

Symbol	Millimeters	
	Min	Max
A	0.40	0.60
A1	0.00	0.05
A3	0.120	0.175
b	0.15	0.25
b1	0.35	0.45
b2	0.20	0.30
D	2.40	2.60
E	0.90	1.10
L	0.28	0.48
L1	0.00	0.15
L2	0.05	0.15
L3	0.35	0.45
L4	0.050 REF	
L5	0.075 REF	
L6	0.225 REF	
e	0.500 BASIC	
h	0.6	0.16

Embossed Carrier Tape & Reel Specification — 1004 DFN Array

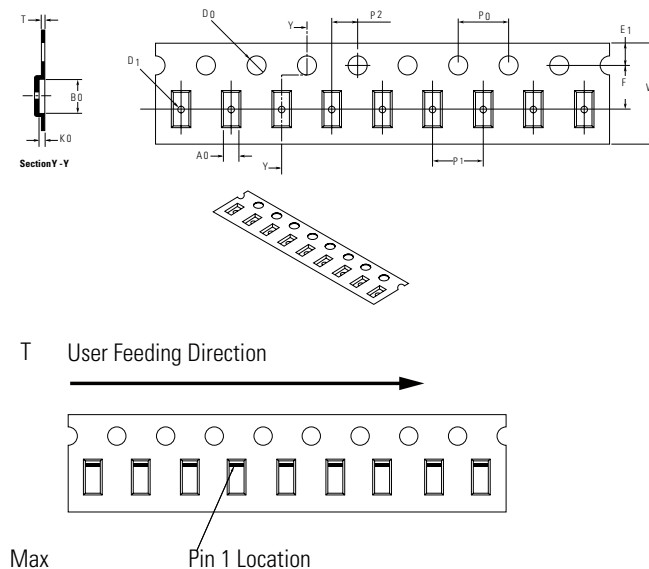

Symbol	Millimeters
A0	1.15 min/1.30 max
B0	2.70+/-0.05
D0	ø 1.50 min/1.65 max
D1	ø 0.50 min/1.05 max
E1	1.75+/-0.10
F	3.50+/-0.10
K0	0.65 min/0.75 max
P0	4.00+/-0.10
P1	4.00+/-0.10
P2	2.00+/-0.05
W	8.00+0.30/-0.10
T	0.17 min/0.30 max

Disclaimer Notice - Information furnished is believed to be accurate and reliable. However, users should independently evaluate the suitability of and test each product selected for their own applications. Littelfuse products are not designed for, and may not be used in, all applications. Read complete Disclaimer Notice at <http://www.littelfuse.com/disclaimer-electronics>.