

AUSMBJ10(C)A-HF Thru. AUSMBJ190(C)A-HF

Working Peak Reverse Voltage: 10 to 190 Volts

Power Dissipation: 600Watts

RoHS Device
Halogen Free

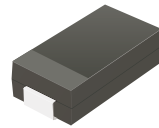

Features

- Low profile package.
- Ideal for automated placement.
- Available in Uni-directional and Bi-directional.
- 600W peak pulse power capability with a 10/1000 μ s waveform.
- Excellent clamping capability.
- Very fast response time.
- Low incremental surge resistance.
- Meets MSL level 1, per J-STD-020C, LF maximum peak of 260°C.
- AEC-Q101 Qualified.

Mechanical Data

- Case: DO-214AA/SMB, molded plastic.
- Epoxy: UL 94V-0 rate flame retardant.
- Terminals: Matte tin plated leads, solderable per J-STD-002 and JESD22-B102.
- Polarity: For Uni-directional types the band denotes end, no marking on Bi-directional types.

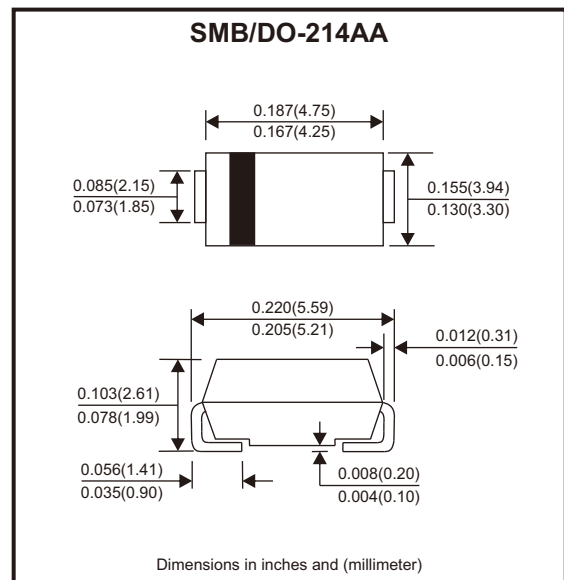

Circuit Diagram

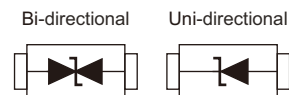

Maximum Ratings and Electrical Characteristics (TA=25°C unless otherwise specified)

Characteristics	Symbol	Value	Units
Peak power dissipation, with a 10/1000 μ s waveform (Note 1, 2) (Fig.1)	P _{PPM}	600	W
Peak pulse current, with a 10/1000 μ s waveform (Note 1)	I _{PPM}	See Next Table	A
Peak forward surge current, 8.3ms single half sine-wave unidirectional only (Note 2)	I _{FSM}	100	A
Maximum instantaneous forward voltage at 50A for unidirectional only (Note 3)	V _F	3.5	V
Typical thermal resistance, junction to lead	R _{θJL}	20	°C/W
Typical thermal resistance, junction to ambient	R _{θJA}	100	°C/W
Operating junction and storage temperature range	T _J , T _{STG}	-55 to +150	°C

Notes: 1. Non-repetitive current pulse, per Fig.3 and derated above Ta = 25°C per Fig.2.

2. Mounted on 0.2 x 0.2" (5.0 x 5.0mm) copper pads to each terminal.

3. V_F < 3.5V for devices of V_{BR} < 190V.

SMD Transient Voltage Suppressor

Electrical Characteristics (TA=25°C unless otherwise specified)

Part No.	Breakdown Voltage V _{BR} @ I _T			Maximum Reverse Leakage @V _{RWM} I _R (μA)	Working Peak Reverse Voltage V _{RWM} (V)	Maximum Reverse Surge Current (Note 1) I _{PP} (A)	Maximum Clamping Voltage @ I _{PP} V _C (V)	Device Marking Code	
	Min. (V)	Max. (V)	I _T (mA) t _p ≤ 50ms					UNI	BI
AUSMBJ10(C)A-HF	11.10	12.30	1	5.0	10.0	35.3	17.0	10A	10CA
AUSMBJ11(C)A-HF	12.20	13.50	1	5.0	11.0	33.0	18.2	11A	11CA
AUSMBJ12(C)A-HF	13.30	14.70	1	5.0	12.0	30.2	19.9	12A	12CA
AUSMBJ13(C)A-HF	14.40	15.90	1	1.0	13.0	27.9	21.5	13A	13CA
AUSMBJ14(C)A-HF	15.60	17.20	1	1.0	14.0	25.9	23.2	14A	14CA
AUSMBJ15(C)A-HF	16.70	18.50	1	1.0	15.0	24.6	24.4	15A	15CA
AUSMBJ16(C)A-HF	17.80	19.70	1	1.0	16.0	23.1	26.0	16A	16CA
AUSMBJ17(C)A-HF	18.90	20.90	1	1.0	17.0	21.7	27.6	17A	17CA
AUSMBJ18(C)A-HF	20.00	22.10	1	1.0	18.0	20.6	29.2	18A	18CA
AUSMBJ19(C)A-HF	21.10	23.30	1	1.0	19.0	19.5	30.8	19A	19CA
AUSMBJ20(C)A-HF	22.20	24.50	1	1.0	20.0	18.5	32.4	20A	20CA
AUSMBJ22(C)A-HF	24.40	26.90	1	1.0	22.0	16.9	35.5	22A	22CA
AUSMBJ24(C)A-HF	26.70	29.50	1	1.0	24.0	15.4	38.9	24A	24CA
AUSMBJ26(C)A-HF	28.90	31.90	1	1.0	26.0	14.3	42.1	26A	26CA
AUSMBJ28(C)A-HF	31.10	34.40	1	1.0	28.0	13.2	45.4	28A	28CA
AUSMBJ30(C)A-HF	33.30	36.80	1	1.0	30.0	12.4	48.4	30A	30CA
AUSMBJ33(C)A-HF	36.70	40.60	1	1.0	33.0	11.3	53.3	33A	33CA
AUSMBJ36(C)A-HF	40.00	44.20	1	1.0	36.0	10.3	58.1	36A	36CA
AUSMBJ40(C)A-HF	44.40	49.10	1	1.0	40.0	9.3	64.5	40A	40CA
AUSMBJ43(C)A-HF	47.80	52.80	1	1.0	43.0	8.7	69.4	43A	43CA
AUSMBJ45(C)A-HF	50.00	55.30	1	1.0	45.0	8.3	72.7	45A	45CA
AUSMBJ48(C)A-HF	53.30	58.90	1	1.0	48.0	7.8	77.4	48A	48CA
AUSMBJ51(C)A-HF	56.70	62.70	1	1.0	51.0	7.3	82.4	51A	51CA
AUSMBJ54(C)A-HF	60.00	66.30	1	1.0	54.0	6.9	87.1	54A	54CA
AUSMBJ58(C)A-HF	64.40	71.20	1	1.0	58.0	6.4	93.6	58A	58CA
AUSMBJ60(C)A-HF	66.70	73.70	1	1.0	60.0	6.2	96.8	60A	60CA
AUSMBJ64(C)A-HF	71.10	78.60	1	1.0	64.0	5.8	103.0	64A	64CA
AUSMBJ70(C)A-HF	77.80	86.00	1	1.0	70.0	5.3	113.0	70A	70CA
AUSMBJ75(C)A-HF	83.30	92.10	1	1.0	75.0	5.0	121.0	75A	75CA
AUSMBJ78(C)A-HF	86.70	95.80	1	1.0	78.0	4.8	126.0	78A	78CA
AUSMBJ80(C)A-HF	88.80	97.60	1	1.0	80.0	4.6	129.6	80A	80CA
AUSMBJ85(C)A-HF	94.40	104.00	1	1.0	85.0	4.4	137.0	85A	85CA
AUSMBJ90(C)A-HF	100.00	111.00	1	1.0	90.0	4.1	146.0	90A	90CA
AUSMBJ100(C)A-HF	111.00	123.00	1	1.0	100.0	3.7	162.0	100A	100CA
AUSMBJ110(C)A-HF	122.00	135.00	1	1.0	110.0	3.4	177.0	110A	110CA
AUSMBJ120(C)A-HF	133.00	147.00	1	1.0	120.0	3.1	193.0	120A	120CA
AUSMBJ130(C)A-HF	144.0	159.0	1	1.0	130.0	2.9	209.0	130A	130CA
AUSMBJ140(C)A-HF	155.0	171.0	1	1.0	140.0	2.7	226.8	140A	140CA
AUSMBJ150(C)A-HF	167.0	185.0	1	1.0	150.0	2.5	243.0	150A	150CA
AUSMBJ160(C)A-HF	178.0	197.0	1	1.0	160.0	2.3	259.0	160A	160CA
AUSMBJ170(C)A-HF	189.0	209.0	1	1.0	170.0	2.2	275.0	170A	170CA
AUSMBJ180(C)A-HF	200.0	220.0	1	1.0	180.0	2.1	291.6	180A	180CA
AUSMBJ190(C)A-HF	211.0	232.0	1	1.0	190.0	2.0	307.8	190A	190CA

Notes: 1. Surge current waveform per Fig.3 and derated per Fig.2.
2. For Bi-directional devices, use suffix CA.

Ratings and Characteristics Curve (AUSMBJ-HF Series)

Fig.1 - Peak Pulse Power Rating Curve

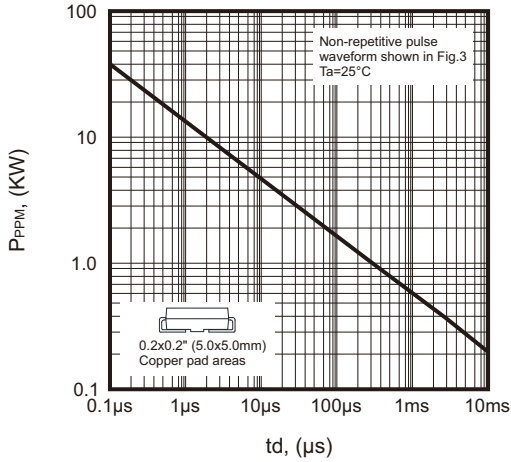

Fig.2 - Pulse Power or Current vs. Initial Junction Temperature

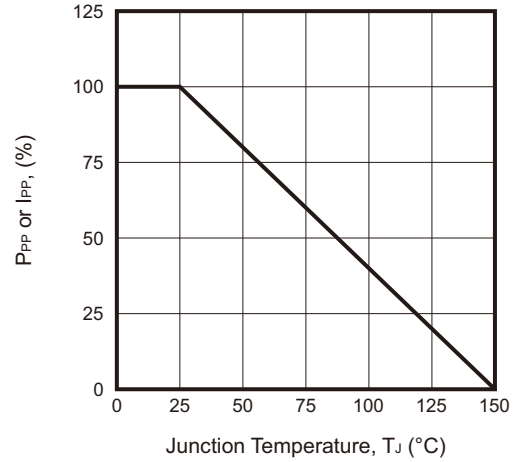

Fig.3 - Pulse Waveform

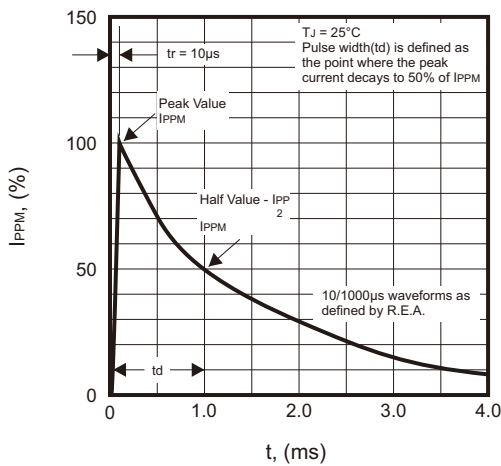

Fig.4 - Typical Transient Thermal Impedance

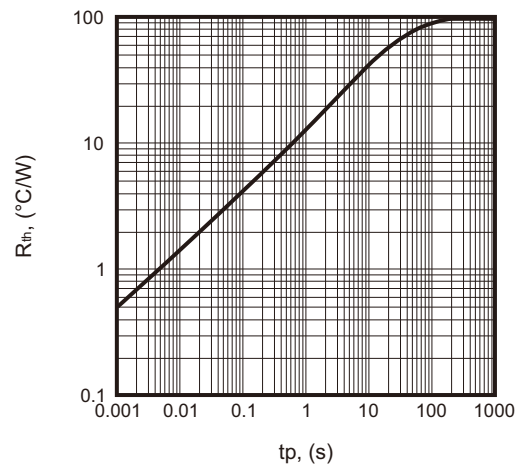
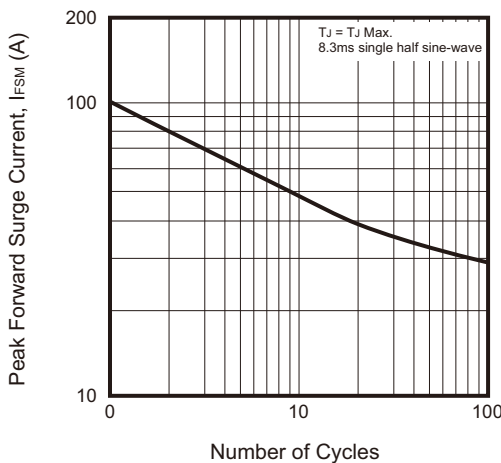
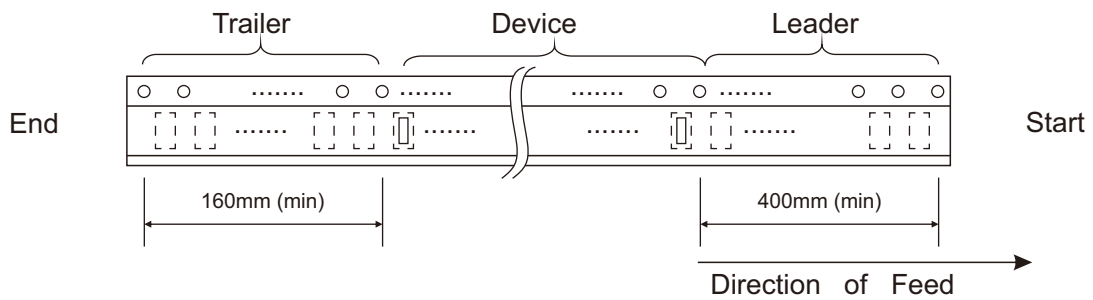
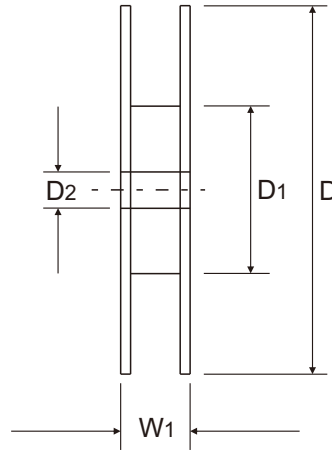
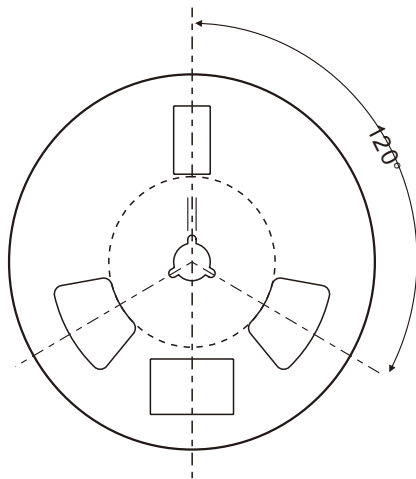
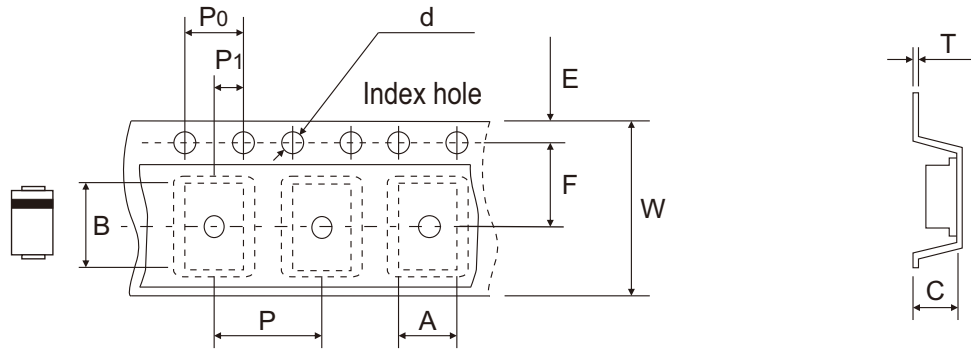

Fig.5 - Maximum Non-Repetitive Surge Current



Reel Taping Specification



DO-214AA (SMB)	SYMBOL	A	B	C	d	D	D1	D2	
	(mm)	See Note 1				1.50 ± 0.05	330.00 Max	100.00 Min	14.00 ± 0.50
	(inch)	See Note 1				0.059 ± 0.002	12.992 Max	3.937 Min	0.551 ± 0.020

DO-214AA (SMB)	SYMBOL	E	F	P	P0	P1	T	W	W1
	(mm)	1.75 ± 0.10	5.50 ± 0.05	8.00 ± 0.10	4.00 ± 0.10	2.00 ± 0.10	0.23 ± 0.10	12.00 ± 0.30	18.00 Max
	(inch)	0.069 ± 0.004	0.217 ± 0.002	0.315 ± 0.004	0.157 ± 0.004	0.079 ± 0.004	0.009 ± 0.004	0.472 ± 0.012	0.709 Max

Note: 1. A, B, and C the clearance between the component and the cavity must be within 0.5mm max. for 8mm tape and 12mm tape, 1.0mm max. for 16mm tape and 24mm tape.

Company reserves the right to improve product design, functions and reliability without notice. REV:A

Marking Code

Part Number	Marking Code
AUSMBJ-HF Series	See Page.2

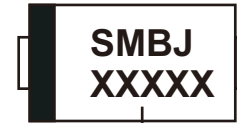

Product type marking code
Cathode band

xxxxx = Marking code (see Page.2)

Suggested P.C.B. PAD Layout

SIZE	DO-214AA(SMB)	
	(mm)	(inch)
A	2.30	0.091
B	2.50	0.098
C	1.80	0.071
D	4.30	0.169
E	6.80	0.268

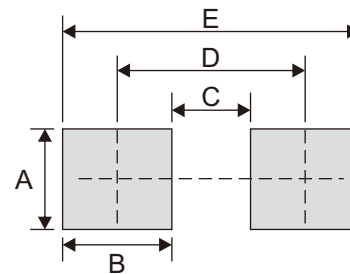

Note: 1. The pad layout is for reference purpose only.

Standard Packaging

Case Type	REEL PACK	
	REEL (pcs)	Reel Size (inch)
DO-214AA (SMB)	3,000	13